

	Características generales del programa.....	2 - 10
	Operaciones Especiales	11
PUERTAS BATIENTES	Información técnica armarios batientes	13 - 16
	Cajas armarios batientes.....	17 - 30
	Puertas para armarios batientes.....	31 - 50
	Opciones para armarios batientes	51 - 66
	Opciones para armarios batientes con Rail System	67 - 77
PUERTAS PLEGABLES	Información técnica armarios plegables.....	79- 82
	Cajas armarios plegables	83 - 94
	Puertas para armarios plegables.....	95 - 108
	Opciones para armarios plegables.....	109 - 122
	Opciones para armarios plegables con Rail System	123 - 134
PUERTAS CORREDERAS EXTERIORES	Información técnica armarios correderas exteriores.....	135 - 138
	Cajas armarios correderas exteriores.....	139 - 146
	Puertas para armarios correderas exteriores	147 - 162
	Opciones para armarios correderas exteriores	163 - 176
	Opciones para armarios correderas exteriores con Rail System	177 - 186
PUERTAS CORREDERAS INTERIORES	Información técnica armarios correderas interiores	189 - 192
	Cajas armarios correderas interiores	193 - 202
	Puertas para armarios correderas interiores.....	203 - 210
	Opciones para armarios correderas interiores.....	211 - 224
	Opciones para armarios correderas interiores con Rail System	225 - 234
VESTIDORES	Fondo 56 sin trasera.....	239 - 252
	Fondo 56 sin trasera con Rail System	253 - 262
	Fondo 58 con trasera.....	263 - 276
	Fondo 58 con trasera con Rail System	277 - 286
	Columnas metálicas	287 - 288
ARMARIOS MODULARES CAMAS	Armarios modulares apilar.....	289 - 299
	Mesa Show.....	300
	Camas y cabezales	301 - 312
	Módulos libre configuración	313 - 320
	Valoración puerta reducida y sustituciones de guías.....	321
	Desglose composiciones catálogo.....	323 - 346
	Condiciones de venta	347

CARACTERÍSTICAS GENERALES DEL PROGRAMA

Estructura y acabados



ENVIANOS TU DISEÑO

NoLimits NEXT significa que tú marcas los límites. Mandanos tu diseño y lo haremos realidad.



AJUSTA SIN INCREMENTO

El concepto NoLimits NEXT llega a su última dimensión. Ajusta tu armario de ancho, alto y fondo sin incremento.



ESCOGE ENTRE TODOS LOS COLORES DISPONIBLES

Puedes escoger el color de tu armario de entre toda la carta de acabados vigente SIN incremento.

Sistemas de apertura



PUERTAS BATIENTES

Funcionales y practicas, elige y combina entre la gran variedad de modelos propuestos.



PUERTAS PLEGABLES

Adaptables, accesibles y muy prácticas. Una vez abiertas, podrás ver todo el interior del armario.

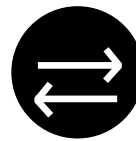

PUERTAS CORREDERAS COLGADAS

Apertura comoda y funcional adaptable a todo tipo de espacios y necesidades.

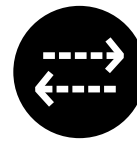

PUERTAS CORREDERAS INTERIORES

Funcionales, discretas y con muchas posibilidades en acabados. Diseñadas para ahorrar espacio.



Complementos interior



CAJONES LIBRE CONFIGURACIÓN

Elige la capacidad de almacenaje de cada cajón. Con guía oculta de extracción total y freno integrado.



ACCESORIOS INTERIOR MEJORADOS

Nuevas barras más resistentes, estantes extraíbles amortiguados y cajones con guía oculta de extracción total y freno integrado. Camiseros, zapateros fijos, extraíbles e inclinados



RAIL SYSTEM

Sistema de canales integrados en la estructura, permiten, modificar y regular en altura la distribución interior cuando tu quieras. Evolución al tradicional sistema de cremallera.



COMPLEMENTOS INTERIOR

Una amplia gama de prestaciones en complementos de interior, de gran belleza y calidad, que ponen el broche final a un armario sobresaliente.



INTERIORES DE ALUMINIO

Estructura interior en aluminio para crear distribuciones interiores de tendencia, modernas y elegantes.

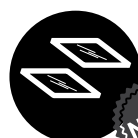

ESTANTES CRISTAL

Estantes de 6 mm de grosor con diferentes acabados, templados para garantizar tu seguridad.

Nuevos acabados stone y cristal



NUEVOS ACABADOS STONE

Se incorporan nuevos acabados para puertas, frentes, cabeceros, forros y tapas



PUERTAS ENMARCADAS CRISTAL

Cristal de 4mm de grosor, templado o con lamina safe para espejos de gran seguridad. Para todos los sistemas de puertas.

CARACTERÍSTICAS TÉCNICAS GENERALES

ESTRUCTURA



Para nosotros cada armario es un elemento único, ya que responde al diseño y preferencias de cada cliente.

Por eso mantenemos la integridad de la superficie realizando los mecanizados solo donde son necesarios.



Por defecto el ajuste de medidas del armario se realiza en todo el conjunto.

Todas las puertas quedan de la misma medida, así se mantiene la armonía y proporciones.



Al escoger los interiores del armario de forma independiente puedes combinar acabados sin límites.

De la propia estructura del armario también puedes modificar el acabado de la trasera sin ningún incremento.



Regulador de altura asegura que el armario siempre este a nivel.



Trasera de 1cm con ranura, garantiza mayor estabilidad y firmeza.



Sumar 1cm a todos los elementos en contacto con el suelo a la altura recogida en tarifa.

CARACTERÍSTICAS TÉCNICAS GENERALES

INTERIORES



Sensor de apertura integrado en la estructura. Escoger entre luz blanca (5000K) o luz cálida (3000K)



Se sirve suelto para fijar a un estante. Acabado blanco o negro. No compatible con cajones. Puertas de 165° no se sirven con bisagras expulsoras



Estantes transparentes de cristal templado, o lacados con sistema SAFE. Grosor de 6 mm.



Nuevo diseño de barra de colgar, línea rectangular en blanco o negro. Incorpora perfil superior para minimizar ruidos.



Zapatero inclinado con perfil metálico. Para medidas especiales de fondo consultar con fábrica.



Estante zapatero extraíble o fijo, con 2 tiras de 7cm. Medidas especiales de fondo consultar con fábrica.



Cajones con guía extracción total. Costillas de altura 11,16 o 22cm para configurar tu cajonera ideal.



Módulo casillero de grueso 19mm estructura exterior y de 10mm estantes y divisiones interiores.

CARACTERÍSTICAS TÉCNICAS GENERALES

INTERIORES RAIL SYSTEM

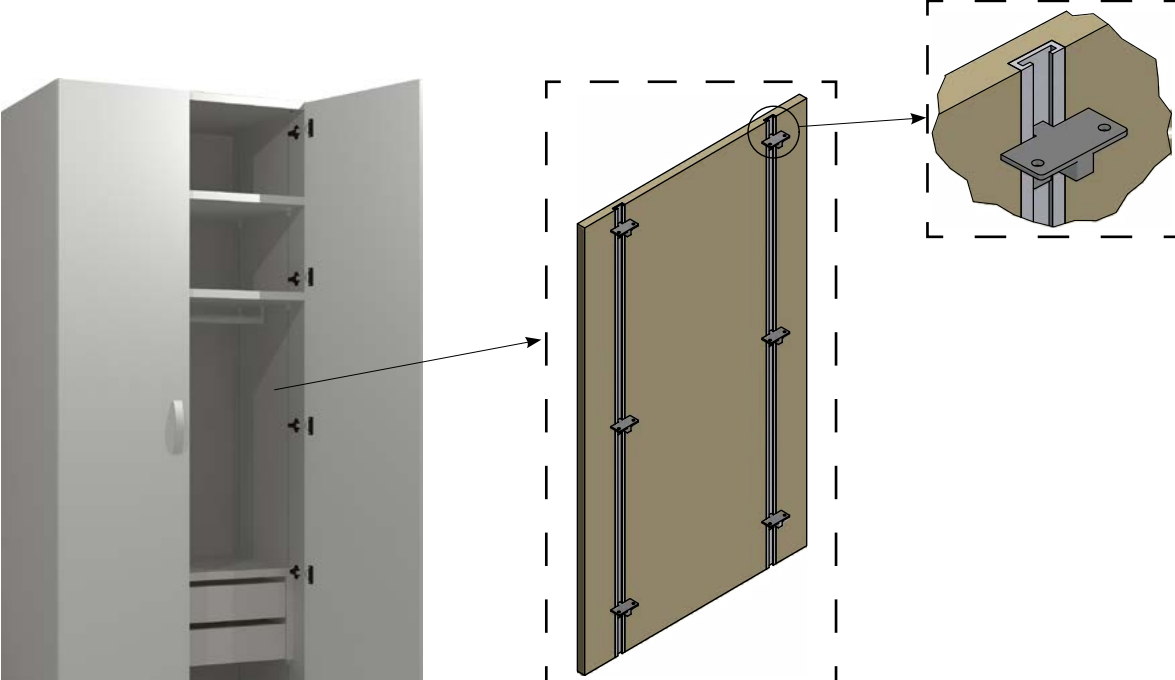

Sistema RAIL SYSTEM

Equipar un hueco con el sistema RAIL SYSTEM te permitirá modificar su distribución interior a tu gusto en cualquier momento. En los laterales se integran canales metálicos acabados en blanco o negro. Todos los interiores de la serie RAIL SYSTEM incorporan los soportes compatibles con el sistema de canales para poder ubicar y fijar estos elementos donde nos apetezca.



ILUMINACIÓN

En el programa de armarios, ofrecemos la posibilidad de incorporar su sistema de iluminación interior, acorde con la calidad de los diferentes elementos del armario. La opción de **“iluminación simple”** o **“iluminación doble”**, junto a su posición vertical en el costado del armario, le proporciona una óptima utilización de todo el potencial lumínico, dando como resultado un armario espectacular, práctico y también exclusivo, ya que la total libertad en la personalización de los interiores, hacen que su armario sea único.

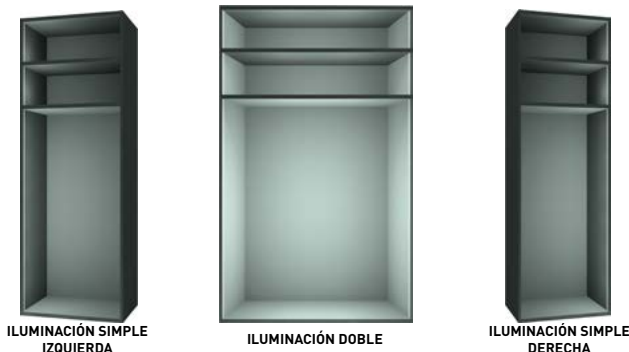

En caso de iluminación, incluir en el pedido el dibujo de la ubicación de los LEDs. Posibilidad de elegir iluminación a la izquierda, derecha o ambas.

Luz LED con 2 opciones, **luz cálida** (3000K) o **luz blanca** (5000K), ambas con una densidad de 60 LEDs/m. Incorpora cable hasta la fuente de alimentación de 2m, esta funciona con un voltaje de 12V y dispone de una conexión para el cable específico de cada país (por defecto conector europeo).

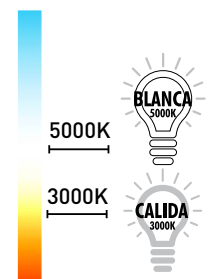

El interruptor es un sensor que se activa automáticamente al detectar el movimiento de la puerta. El sensor queda perfectamente integrado en la estructura del armario.



TABLEROS



- Los tableros utilizados tienen una medida de 282x208cm para acabados base, en el caso de acabados stone 277x205cm.
- Los gruesos disponibles son 1, 1.9, 3 y 5cm para acabados base, para acabados stone 1 y 1.9cm
 - Formados por partículas de madera y resina compactadas.
 - El tablero resultante es recubierto por diferentes papeles decorativos (80-160g/m2).

Nuestros tableros provienen de empresas certificadas PEFC (Programa de Reconocimiento de Gestión Forestal) por lo que cuando adquiera un producto jotajotape estará promoviendo la gestión forestal sostenible. Además sus propiedades mecánicas resistencia a la tracción, resistencia a la flexión, tracción superficial, cumplen con los más altos estándares de calidad según EN319, EN310 y EN311 respectivamente. Por lo que respecta a la calidad del acabado y resistencia de la superficie; resistencia a la abrasión, rayado, fisuras, manchas y al impacto nuestros productos también satisfacen los niveles de calidad más exigentes según EN14323.

CANTOS

- Los cantos serán del mismo acabado que la madera por defecto.
Posibilidad de cantar con distinto acabado, con incremento de precio previa consulta y valoración con fábrica.
Los cantos que recubren los laterales son de PVC de 0,8 y 2mm para acabados base, excepto acabados stone siempre en 0.8cm.
- Para adherir el canto a la pieza se utilizan colas tipo PUR y EVA

Los cantos que incorporan nuestros productos son producidos a partir de PVC de la más alta calidad, elemento que les confiere las siguientes propiedades;
Alta resistencia mecánica, superando los más exigentes controles de tracción y dureza (MTD.01 y MTD.05 respectivamente).
Excelente estabilidad del nivel de acabado y resistencia de superficie cumpliendo con los más altos estándares en resistencia a la suciedad, rayado, agentes químicos y manchas, solidez a la luz solar y cambios repentinos de temperatura (según UNI9300, UNI9428, UNI9114/87, UNI9427 y UNI9429 respectivamente).

PIEZAS METÁLICAS



Acabados estándar blanco y vulcano para todas las piezas metálicas excepto pata TUB.

PERFILERÍA



Respecto a la perfilería de las puertas, está disponible en todos los acabados lisos de la carta vigente de jotajotape, sin incremento, y queda excluido cualquier acabado con malla. Se añaden 3 acabados exclusivos para lacar de color, que son el **Aurum**, **Cobre** y **Titanium**.

TAPIZADOS



Disponemos de 7 acabados en tapizados que podrán utilizarse en diferentes piezas como:

- ARRIMADEROS
- CABECEROS (Desenfundables)
- CANAPÉS (Desenfundables)
- CAMAS (Desenfundables)
- COJINES (Desenfundables)

Lavado a máquina o en seco 30% poliéster - 70% algodón
Seleccionar el tapizado siempre a partir de las muestras facilitadas en el muestrario, ya que los colores no corresponden a los colores de las melaminas.

LACADOS Y COLOR CLIENTE

Lacar referencias completas se aplicará un 40% de incremento.
Para estas piezas específicas se especifica referencia e incremento.

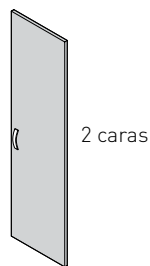
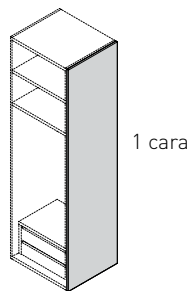
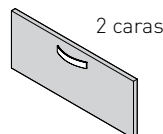
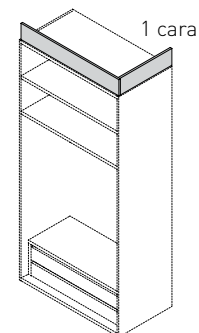

**Para colores carta RAL
mínimo de 176 puntos por color**

**Puerta****Forro****Frente****Tirador****Tapeta**

- 1 Incluir en el pedido la referencia del color de la carta NCS y RAL, en ningún caso se aceptarán muestras físicas.
- 2 El color cliente esta pensado únicamente para piezas exteriores del armario como puertas y forros laterales.
- 3 Pueden haber pequeñas diferencias entre la muestra de color vista en el muestrario y el resultado de aplicar el color en el mueble, básicamente por matices provocados por el grado de brillo, aplicación en diferentes tipos de soportes (papel, tablero, etc.).
Por este motivo jotajotape no se hace responsable de aquellos cambios derivados de estas pequeñas variaciones.
- 4 Por cada color cliente que se aplique hay un **mínimo 176 puntos**.
En el caso de no llegar al mínimo en el conjunto de piezas del mismo color, se aplicará esta cantidad.

TENSORES

En algunos casos, de puertas correderas exteriores e interiores, a causa de las tensiones de los diferentes materiales que componen las puertas, se precisa la colocación de tensores. Estos quedan ocultos en la parte posterior de la puerta, pero accesibles para cuando sea preciso realizar algún ajuste.

CAJONES

Acabado interior color arena. Guías utilizadas:

- Cajoneras para armarios, tanto interior como exterior, guías ocultas con sistema de freno integrado y **extracción total**.
- Cajones módulos libre configuración pág. 289 y modulares apilar pág. 313 con sistema de freno integrado y **extracción total**.
- Cajones para camas, guías ocultas con sistema de freno integrado, **extracción parcial**.

Información importante

Evitar el uso de productos de limpieza que contengan acetona, tricloroetileno y etil butil acetatos para garantizar un mantenimiento óptimo del nivel de acabados del canto.

Acabados VETA



54 ABETO



94 FRIDA



53 NORDICO



65 FOREST



97 LOIRA



98 NORA



97 LIVORNO

Acabados STONE



BIANCO



OXID

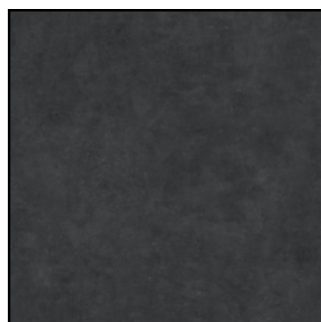

BLACK STONE



ROMA



ROYAL



Tableros de 277x205 cm de medida máxima
Grosor de 1, 1.9 y 3 cm
Canteado 0.8 mm



Incremento de 8% en elementos todo acabado STONE
Puertas módulo en STONE incremento 8 puntos/puerta
Frente cajones módulo o cubos en STONE
incremento 3 puntos/frente. Para piezas sueltas consultar.

Esta norma anula la anterior en páginas 292 a 294 y 316 a 318

Se especifican en cada tirador, puerta y caja las opciones disponibles de acabados.

Acabados UNICOLOR

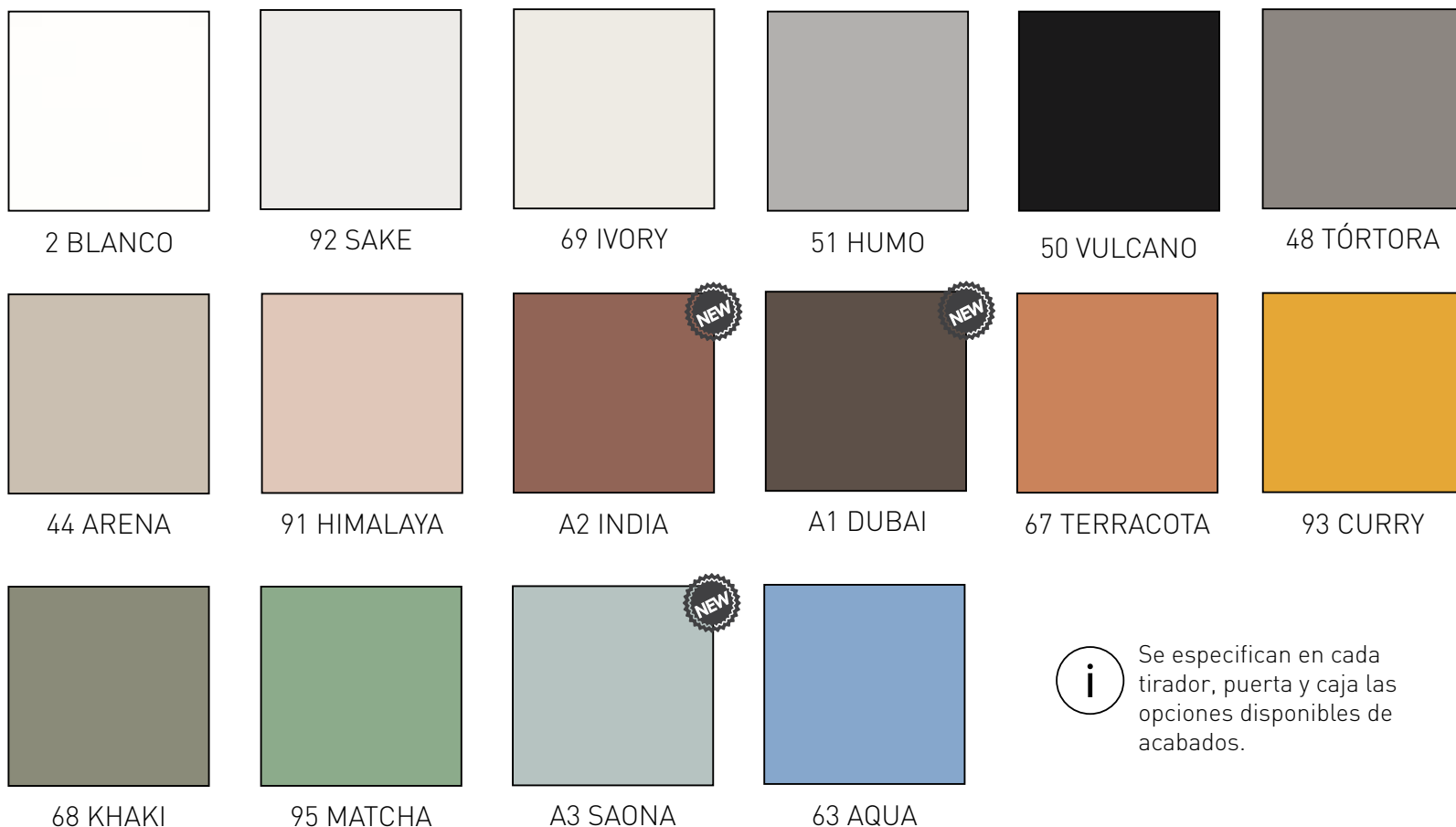

i Se especifican en cada tirador, puerta y caja las opciones disponibles de acabados.

Acabados PARA LACAR

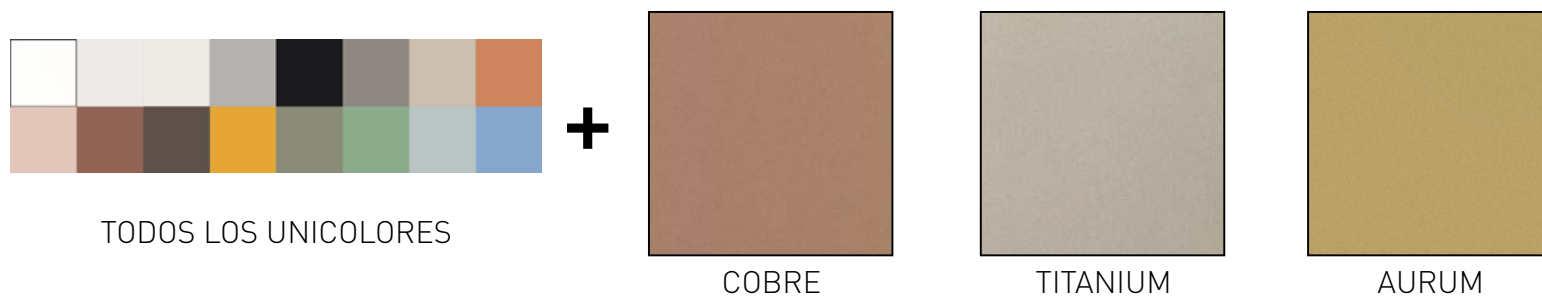

Tapizados



i Artículos tapizados con tela cliente no serán desenfundables.

Acabados CRISTAL 

Cristales transparentes



NETO



LATÓN



FOSCO

Cristales translúcidos



ARTIC



BLACK

Cristales lacados (Opacos)



LACADO BLANCO



LACADO CREMA



LACADO VULCANO

* Consultar en www.jotajotape.com otros acabados cristal lacados disponibles.

Espejos



MIRROR



BRONCE

Relieve



VETA



QUADRATO



FUMÉ



Cristales Relieve
medida máxima de cristal 254 cm

LIMITACIONES ACABADOS CRISTALES

Para estantes de cristal de 6mm de grueso

Disponibles acabados NETO, LATON, ARTIC, LACADOS, MIRROR Y FUME

Puertas correderas interiores

Solo cristales lacados y espejos

VALORACIÓN OPERACIONES ESPECIALES

- Medida superior sin incremento por recortar en alto, ancho o fondo.
- En caso de ampliar en fondo, aplicar un 15% de incremento hasta 75cm, para medidas superiores consultar valoración con fábrica.
- Sin incremento por escoger cualquier acabado base de la carta vigente de jotajotape.
- En caso de cortar fondo, hay que tener en cuenta el fondo mínimo para incorporar una cajonera.

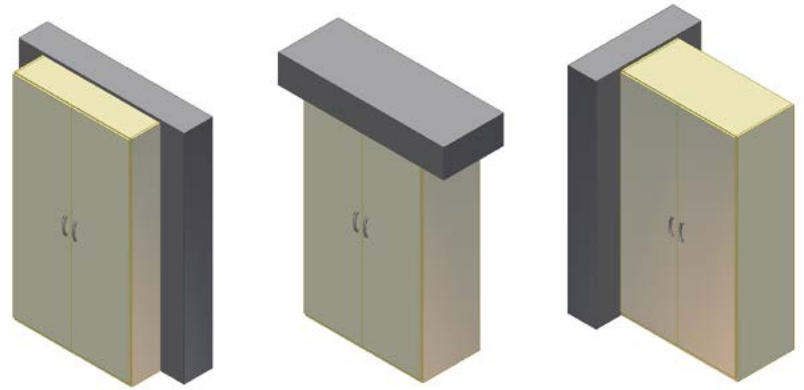

Ajusta sin incremento en cualquier dirección

Cajeado lateral



195 puntos

Cajeado central



195 puntos

Cajeado horizontal (viga)



195 puntos

Cajeado rincón

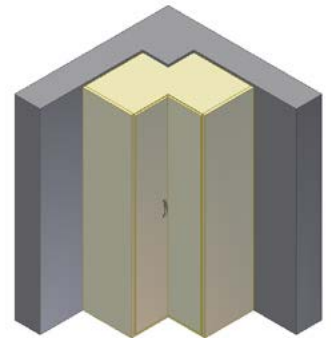

195 puntos

Cajeado horizontal rincón

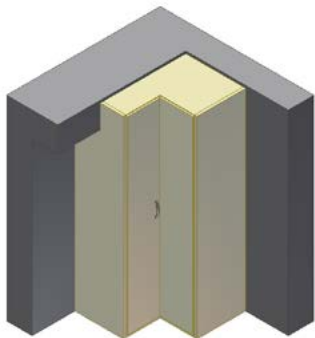

195 puntos

Buhardilla

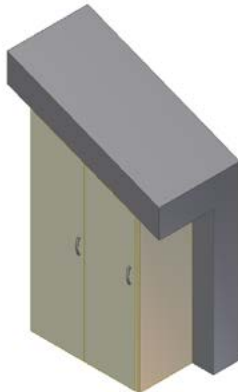

100 puntos por cuerpo abuhardillado

Taladros cremallera y recalada LED

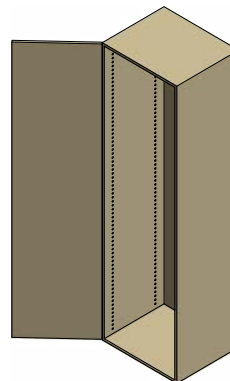

20 puntos por metro lineal

Encaste zócalo

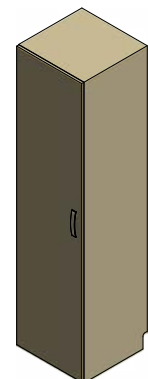

20 puntos por cuerpo con encaste zócalo

Todos los puntos son por cuerpo modificado, se recoge en el precio de la caja.

CARACTERÍSTICAS TÉCNICAS ARMARIOS BATIENTES

Distribución interior según diseño cliente.

Mantiene integridad superficie con taladros donde sean necesarios

Bisagras con sistema de cierre amortiguado.

Costados y divisiones canteados en los 4 costados

Todas las puertas mantienen la misma medida al recortar

Trasera de 10mm con ranura, garantiza mayor estabilidad y firmeza. Facilita el montaje vertical

Sistema de fijación de estantes con bloqueo, mejora seguridad y capacidad de carga

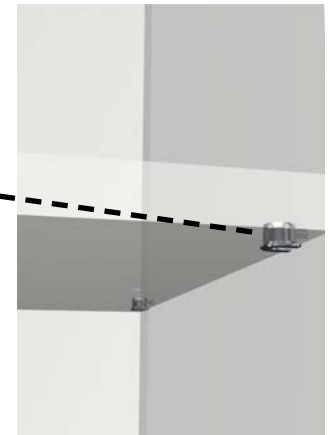

Regulador de altura asegura que el armario siempre este a nivel

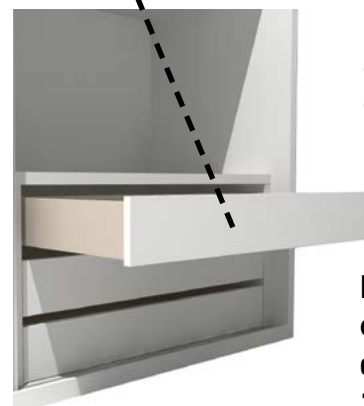

Cajones con sistema de cierre amortiguado

Extracción total y libre configuración de altura de costillas entre 11, 16 y 22cm

IMPRESINDIBLE enviar dibujo de la distribución interior.

MATERIALES ESTRUCTURA

Costados:	Grueso de 19mm, canteados con PVC de 0.8mm, los 4 costados.
Bucs superior e inferior:	Grueso de 30mm, canteados con PVC de 0.8mm.
Divisiones interiores:	Grueso de 30mm, canteados con PVC de 0.8mm, los 4 costados.
Trasera:	Grueso de 10mm.
Estantes interiores:	Grueso de 30mm, canteados con PVC de 0.8mm, los 4 costados.

COLORES DISPONIBLES

Carta de colores vigente de jotajotape



NUEVOS MATERIALES

Acabados STONE



Acabados STONE solo disponible en grueso 19mm y 10mm. Canteado siempre en PVC 0.8mm. Disponible para frentes, traseras, forros, tapetas y tapas.

Acabados CRISTALES



Cristales con cantos pulidos de 4mm de grosor para puertas y 6mm para estantes. Para los acabados transparente, lacado, translucido y relieves, cristal templado y en el caso de espejos con lamina safe.

INFORMACIÓN TÉCNICA ESTRUCTURA

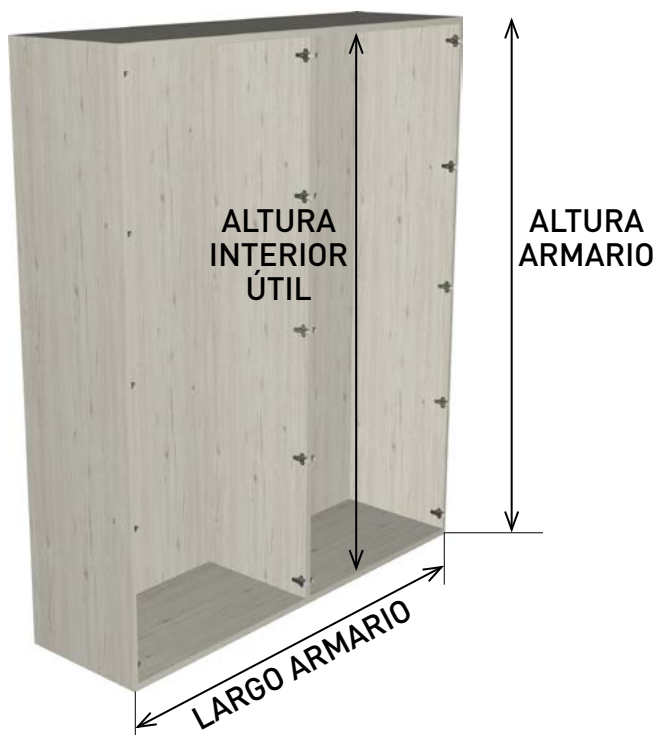

MEDIDAS A CONSIDERAR AL REALIZAR EL PEDIDO

$$\text{Altura interior útil} = \text{Altura armario} - 6\text{cm}$$

$$\text{Fondo mínimo armario para contener una cajonera (Caja+Puerta)} = 45\text{cm}$$

$$\text{Fondo mínimo armario para incorporar cajón exterior (Caja+Puerta)} = 33\text{cm}$$



MEDIDAS MÍNIMAS NECESARIAS PARA MONTAJE

$$\text{Altura hueco} = \text{Altura armario} + 3\text{cm}$$

$$\text{Largo hueco} = \text{Largo armario} + 5\text{cm}$$

CARACTERÍSTICAS TÉCNICAS PUERTAS BATIENTES

FRENTES



Sea cual sea la medida del armario todas las puertas mantienen la proporción.



Holgura inferior puerta 2mm sobre la caja, y 12mm del suelo al considerar el regulador. Igual que la línea del catálogo de mueble juvenil.

NUEVOS ACABADOS FRENTES



Se incorporan 5 nuevos acabados STONE, para dar un acento original y elegante.



Gran variedad de acabados cristal, a escoger entre transparentes, translúcidos, lacados, relieves y espejos.

BISAGRAS

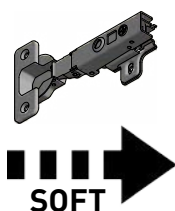

Bisagras de ajuste rápido con cierre amortiguado y regulación en altura y profundidad.

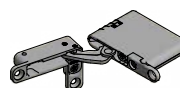

Nueva opción bisagras AIR integradas en la estructura. Solo disponible para armarios rectos de 1 o 2 puertas. Altura máxima armario 239cm. No compatible con armario rincón.

NUEVOS MODELOS DE PUERTAS



ONIX



LUX



CRAFT



AIR



RELIEF

PASOS PARA CONFECCIONAR UN ARMARIO

1. Elegir caja



SIN DISTRIBUCIÓN
INTERIOR

2. Puerta



de pág. 31 a 50

3. Opciones

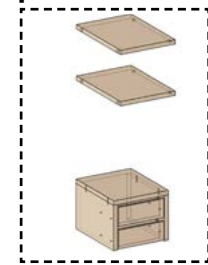

de pág.
51 a 66

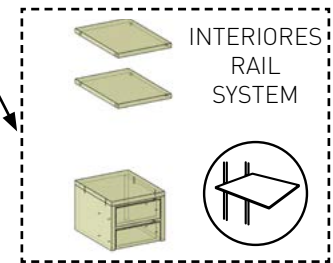

de pág.
67 a 77

IMPRESINDIBLE ENVIAR DIBUJO DE LA DISTRIBUCIÓN INTERIOR.

MEDIDAS ESPECIALES

Elegir la medida superior y cortar, sin incremento.

CAJAS ARMARIO

La caja del armario no incluye estantes ni barra para colgar.
En todos los casos el fondo 60cm indica la caja de 58cm + el grosor de las puertas.
En caso de elegir solo la caja sin puertas el fondo es 58cm.

PUERTAS

El ancho máximo de puerta es de 60 cm.

MONTAJE

Para montar un armario en un hueco es necesario disponer de **5cm** libres para su montaje lateral, y de **3cm** libres para su montaje superior. Si es posible montar el armario e introducir éste en el hueco, no hace falta disponer de las distancias marcadas anteriormente.

REGULACIÓN

Información importante

Regulación entre 10 y 30mm para compensar desvío de suelo. Estos 10mm se deben considerar para la altura total (no están contabilizados en las medidas de tarifa)

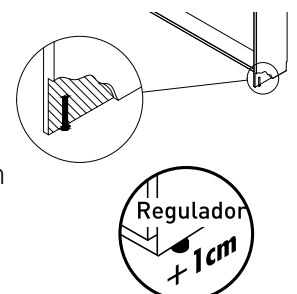

EJEMPLO SELECCIÓN DE ARMARIO

El cliente desea un armario de 175 cm, de 239 cm de altura

Buscar la caja de medida superior, en este caso 180 cm, que tiene dos cuerpos y su altura correspondiente.

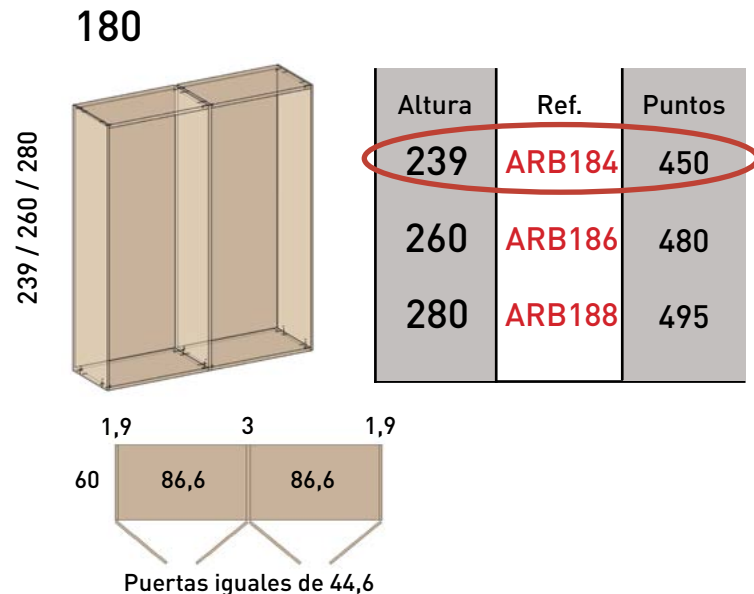

Que características tiene el armario y cual es su valor en puntos

Con la referencia **ARB184** tenemos un armario de 175 cm ancho, 239 cm alto y 58 de fondo (sin las puertas).

El espacio interior que nos queda es menor que el de armario de 180 y las puertas lógicamente también quedan más pequeñas, pero siempre todas iguales.

No hay incremento en los puntos por cortar el armario, por eso su valor es **450 puntos**

En resumen: Solo se tiene que elegir **ARB184** a 175 cm y jotajotape se encarga del resto.

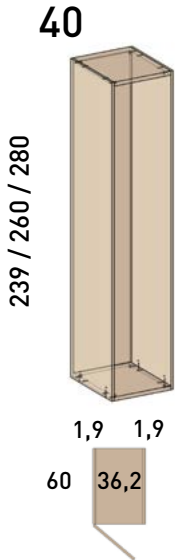

Puerta de 39,6

Altura	Ref.	Puntos
239	ARB44Z	176
260	ARB46Z	199
280	ARB48Z	211



Puerta AIR solo altura 239
Interiores compatibles fondo 47,5
pág 56 y fondo 55 pag. 168

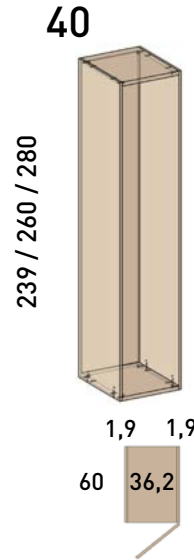

Puerta de 39,6

Altura	Ref.	Puntos
239	ARB44D	176
260	ARB46D	199
280	ARB48D	211



Puerta AIR solo altura 239
Interiores compatibles fondo 47,5
pág 56 y fondo 55 pag. 168

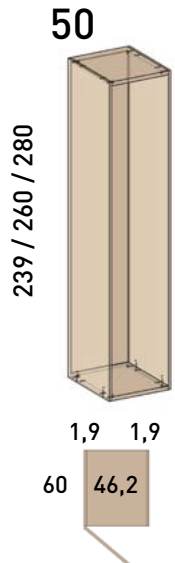

Puerta de 49,6

Altura	Ref.	Puntos
239	ARB54Z	187
260	ARB56Z	212
280	ARB58Z	225



Puerta AIR solo altura 239
Interiores compatibles fondo 47,5
pág 56 y fondo 55 pag. 168

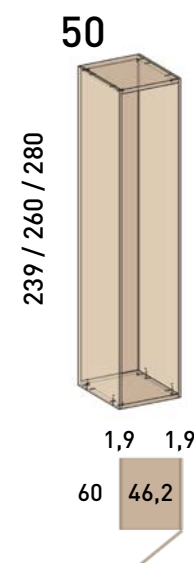

Puerta de 49,6

Altura	Ref.	Puntos
239	ARB54D	187
260	ARB56D	212
280	ARB58D	225



Puerta AIR solo altura 239
Interiores compatibles fondo 47,5
pág 56 y fondo 55 pag. 168

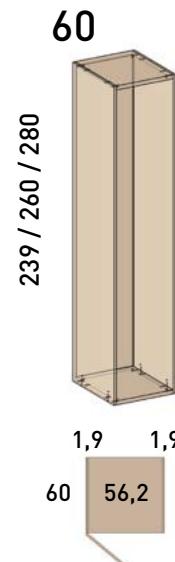

Puerta de 59,6

Altura	Ref.	Puntos
239	ARB64Z	200
260	ARB66Z	227
280	ARB68Z	241



Puerta AIR solo altura 239
Interiores compatibles fondo 47,5
pág 56 y fondo 55 pag. 168

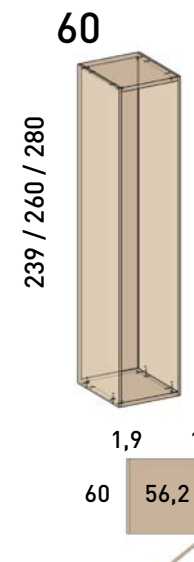

Puerta de 59,6

Altura	Ref.	Puntos
239	ARB64D	200
260	ARB66D	227
280	ARB68D	241



Puerta AIR solo altura 239
Interiores compatibles fondo 47,5
pág 56 y fondo 55 pag. 168

Puertas para armarios batientes en pág. 31. Complementos interior en pág 51.

Para cajas de armario con RAIL SYSTEM complementos interior en pág 67.

Para medidas intermedias, coger referencia de medida superior y cortar sin incremento (largo, alto y fondo)

70

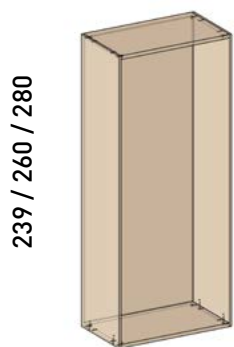

239 / 260 / 280

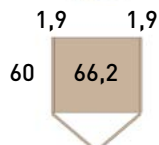

Puertas iguales de 34,6

Altura	Ref.	Puntos
239	ARB74	216
260	ARB76	240
280	ARB78	255



Puerta AIR solo altura 239
 Interiores compatibles fondo 47,5
 pág 56 y fondo 55 pag. 168

80

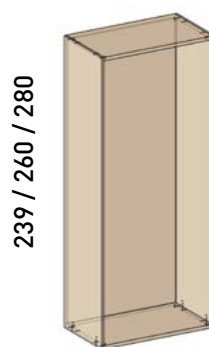

239 / 260 / 280

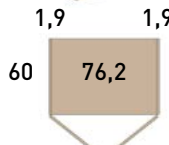

Puertas iguales de 39,6

Altura	Ref.	Puntos
239	ARB84	231
260	ARB86	262
280	ARB88	278



Puerta AIR solo altura 239
 Interiores compatibles fondo 47,5
 pág 56 y fondo 55 pag. 168

90

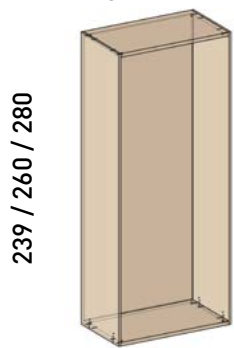

239 / 260 / 280

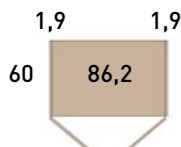

Puertas iguales de 44,6

Altura	Ref.	Puntos
239	ARB94	245
260	ARB96	278
280	ARB98	295



Puerta AIR solo altura 239
 Interiores compatibles fondo 47,5
 pág 56 y fondo 55 pag. 168

100

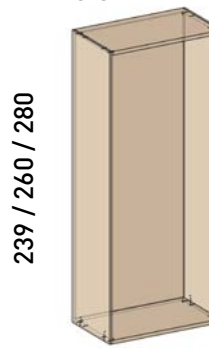

239 / 260 / 280

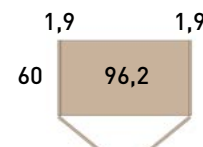

Puertas iguales de 49,6

Altura	Ref.	Puntos
239	ARB104	261
260	ARB106	292
280	ARB108	308



Puerta AIR solo altura 239
 Interiores compatibles fondo 47,5
 pág 56 y fondo 55 pag. 168

110

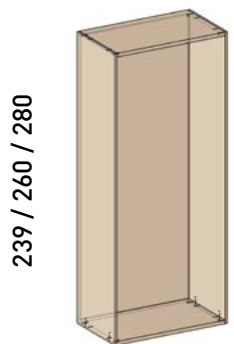

239 / 260 / 280

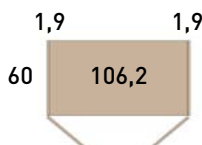

Puertas iguales de 54,6

Altura	Ref.	Puntos
239	ARB114	276
260	ARB116	306
280	ARB118	323



Puerta AIR solo altura 239
 Interiores compatibles fondo 47,5
 pág 56 y fondo 55 pag. 168

120

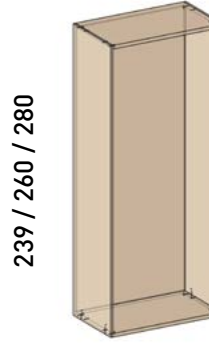

239 / 260 / 280

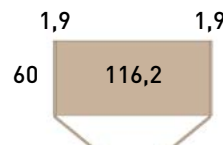

Puertas iguales de 59,6

Altura	Ref.	Puntos
239	ARB124	291
260	ARB126	330
280	ARB128	345



Puerta AIR solo altura 239
 Interiores compatibles fondo 47,5
 pág 56 y fondo 55 pag. 168

Puertas para armarios batientes en pág. 31. Complementos interior en pág 51.

Para cajas de armario con RAIL SYSTEM complementos interior en pág 67.

Para medidas intermedias, coger referencia de medida superior y cortar sin incremento (largo, alto y fondo)

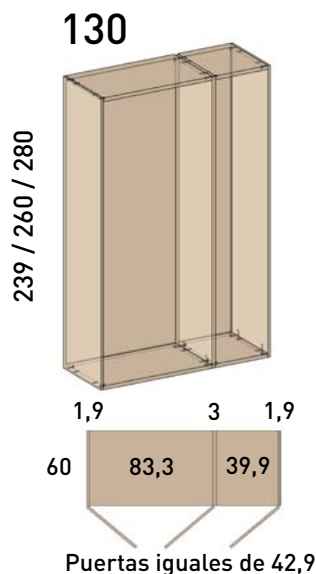

Altura	Ref.	Puntos
239	ARB134	340
260	ARB136	370
280	ARB138	385

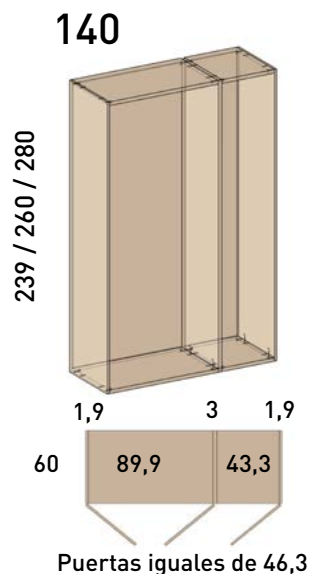

Altura	Ref.	Puntos
239	ARB144	362
260	ARB146	392
280	ARB148	407

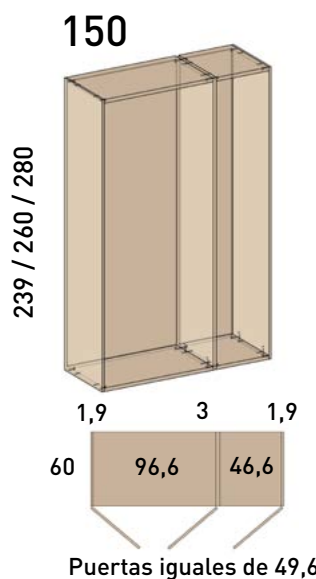

Altura	Ref.	Puntos
239	ARB154	384
260	ARB156	414
280	ARB158	429

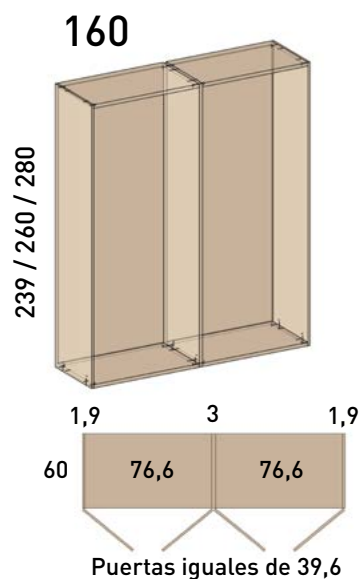

Altura	Ref.	Puntos
239	ARB164	406
260	ARB166	436
280	ARB168	451

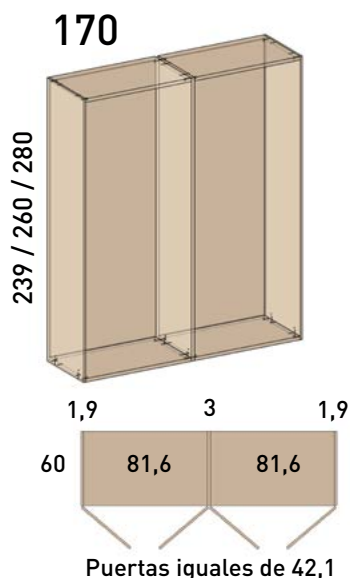

Altura	Ref.	Puntos
239	ARB174	428
260	ARB176	458
280	ARB178	473

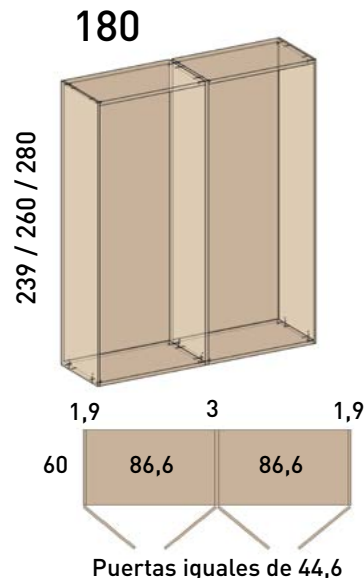

Altura	Ref.	Puntos
239	ARB184	450
260	ARB186	480
280	ARB188	495

Puertas para armarios batientes en pág. 31. Complementos interior en pág 51.

Para cajas de armario con RAIL SYSTEM complementos interior en pág 67.

Para medidas intermedias, coger referencia de medida superior y cortar sin incremento (largo, alto y fondo)

190

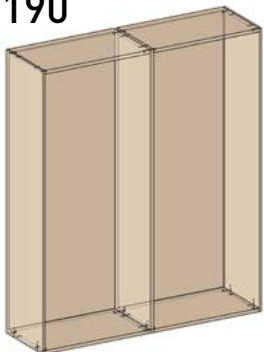

Altura	Ref.	Puntos
239	ARB194	472
260	ARB196	502
280	ARB198	517

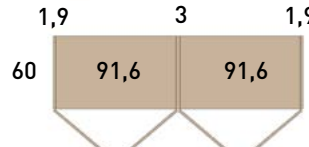

Puertas iguales de 47,1

200

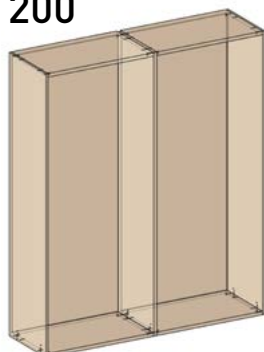

Altura	Ref.	Puntos
239	ARB204	494
260	ARB206	524
280	ARB208	539

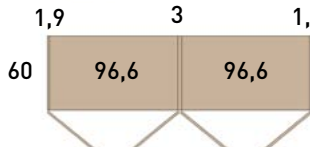

Puertas iguales de 49,6

210

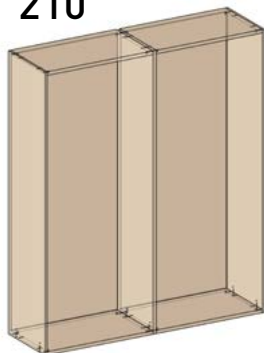

Altura	Ref.	Puntos
239	ARB214	516
260	ARB216	546
280	ARB218	561

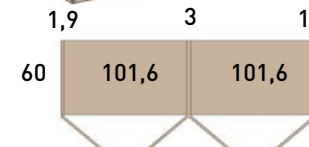

Puertas iguales de 52,1

220

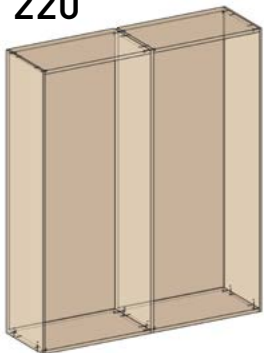

Altura	Ref.	Puntos
239	ARB224	538
260	ARB226	568
280	ARB228	583

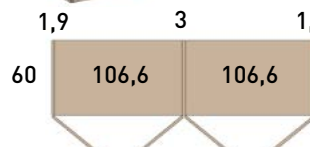

Puertas iguales de 54,6

230

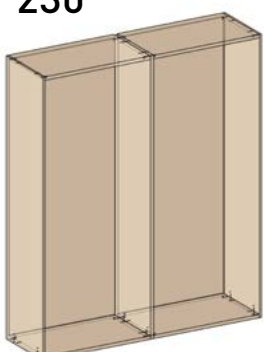

Altura	Ref.	Puntos
239	ARB234	560
260	ARB236	590
280	ARB238	605



Puertas iguales de 57,1

240

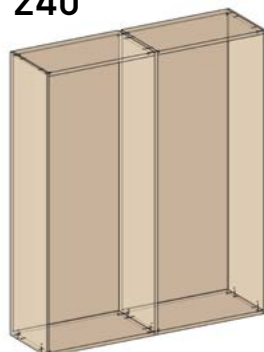

Altura	Ref.	Puntos
239	ARB244	578
260	ARB246	608
280	ARB248	623

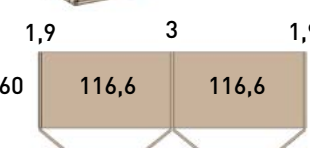

Puertas iguales de 59,6

Puertas para armarios batientes en pág. 31. Complementos interior en pág 51.

Para cajas de armario con RAIL SYSTEM complementos interior en pág 67.

Para medidas intermedias, coger referencia de medida superior y cortar sin incremento (largo, alto y fondo)

250

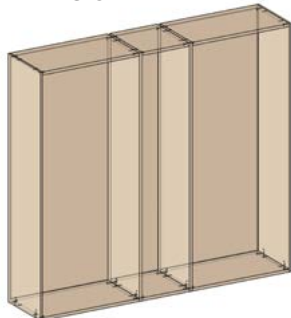

Altura	Ref.	Puntos
239	ARB254	640
260	ARB256	680
280	ARB258	695

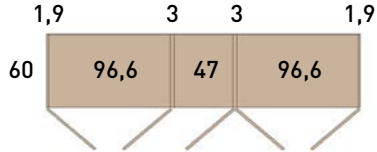

Puertas iguales de 49,6

260

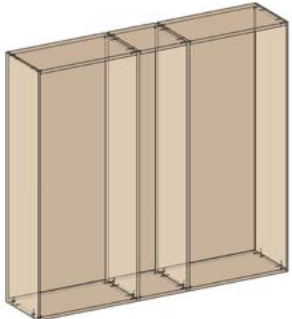

Altura	Ref.	Puntos
239	ARB264	656
260	ARB266	702
280	ARB268	730

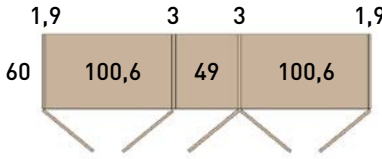

Puertas iguales de 51,6

270

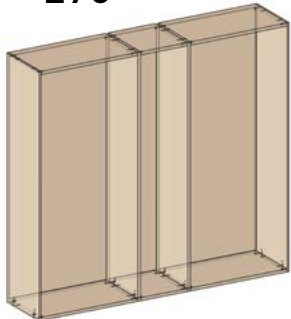

Altura	Ref.	Puntos
239	ARB274	672
260	ARB276	724
280	ARB278	764

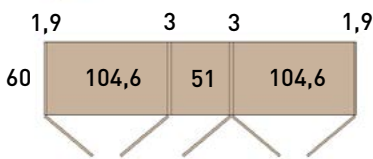

Puertas iguales de 53,6

280

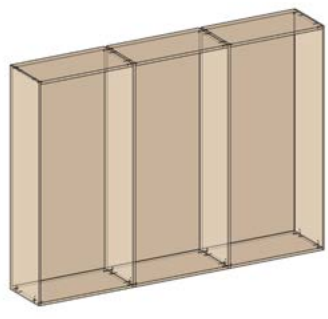

Altura	Ref.	Puntos
239	ARB284	688
260	ARB286	746
280	ARB288	800

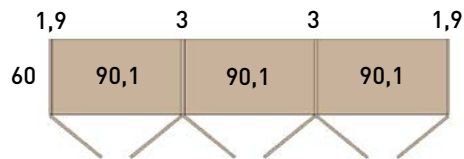

Puertas iguales de 46,3

290

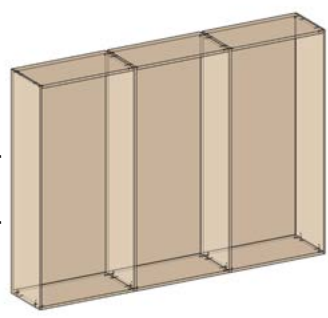

Altura	Ref.	Puntos
239	ARB294	704
260	ARB296	768
280	ARB298	834

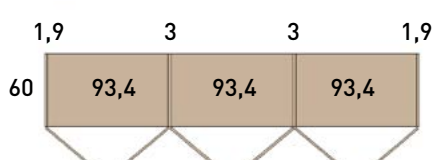

Puertas iguales de 47,9

300

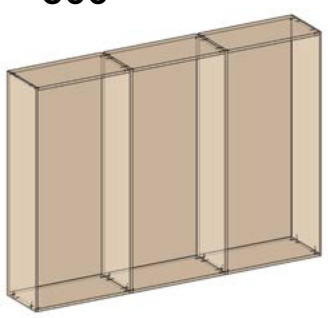

Altura	Ref.	Puntos
239	ARB304	720
260	ARB306	792
280	ARB308	866

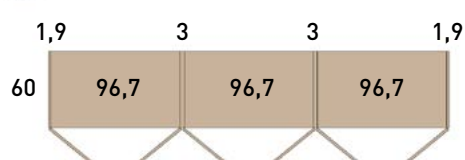

Puertas iguales de 49,6

Puertas para armarios batientes en pág. 31. Complementos interior en pág 51.

Para cajas de armario con RAIL SYSTEM complementos interior en pág 67.

Para medidas intermedias, coger referencia de medida superior y cortar sin incremento (largo, alto y fondo)

310

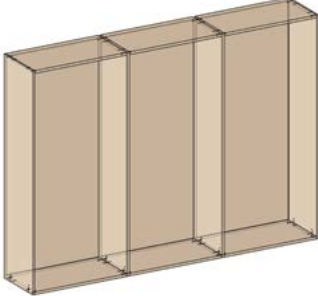

Altura	Ref.	Puntos
239	ARB314	736
260	ARB316	808
280	ARB318	890

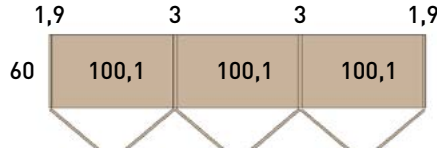

Puertas iguales de 51,3

320

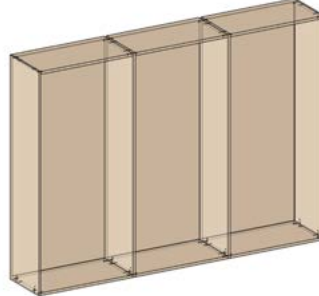

Altura	Ref.	Puntos
239	ARB324	752
260	ARB326	824
280	ARB328	914

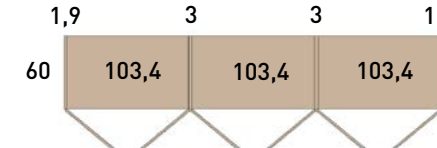

Puertas iguales de 52,9

330

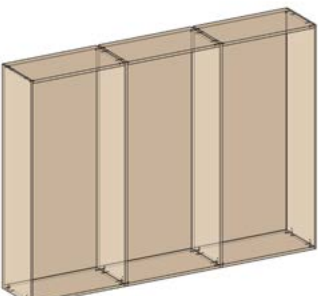

Altura	Ref.	Puntos
239	ARB334	768
260	ARB336	840
280	ARB338	938

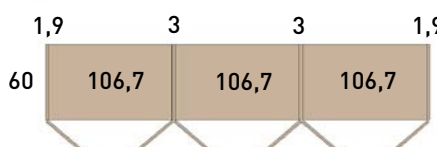

Puertas iguales de 54,6

340

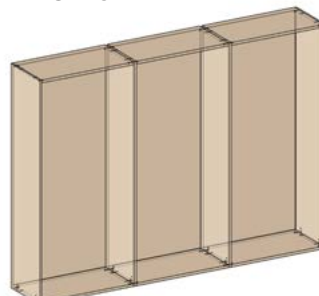

Altura	Ref.	Puntos
239	ARB344	784
260	ARB346	856
280	ARB348	962

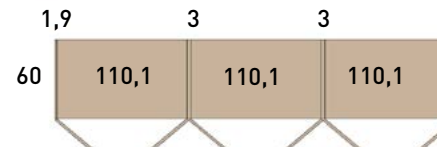

Puertas iguales de 56,3

350

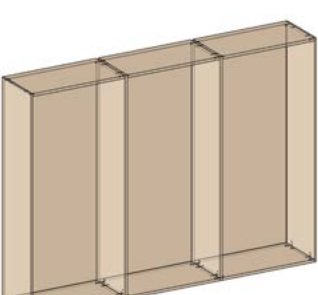

Altura	Ref.	Puntos
239	ARB354	800
260	ARB356	872
280	ARB358	986

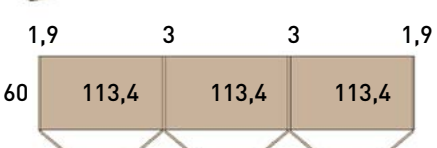

Puertas iguales de 57,9

360

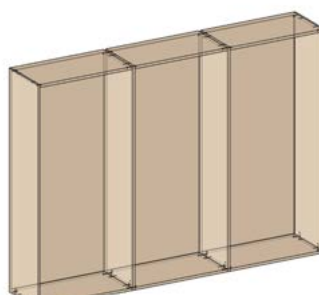

Altura	Ref.	Puntos
239	ARB364	816
260	ARB366	888
280	ARB368	1006

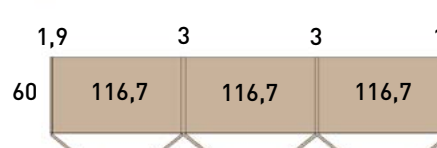

Puertas iguales de 59,6

Puertas para armarios batientes en pág. 31. Complementos interior en pág 51.

Para cajas de armario con RAIL SYSTEM complementos interior en pág 67.

Para medidas intermedias, coger referencia de medida superior y cortar sin incremento (largo, alto y fondo)

370

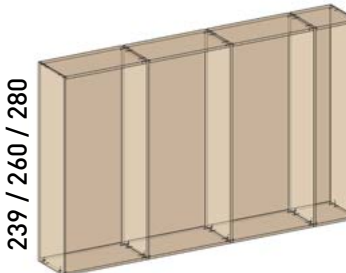

Altura	Ref.	Puntos
239	ARB374	874
260	ARB376	998
280	ARB378	1061

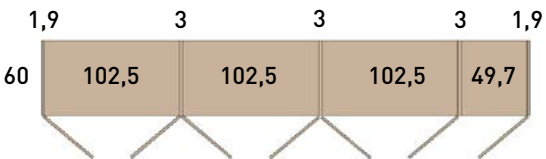

Puertas iguales de 52,6

380

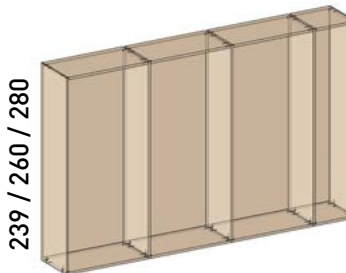

Altura	Ref.	Puntos
239	ARB384	900
260	ARB386	1028
280	ARB388	1092

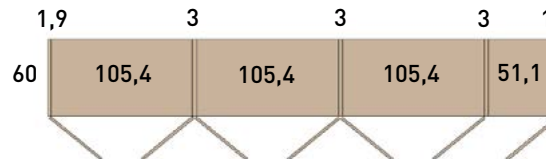

Puertas iguales de 54

390

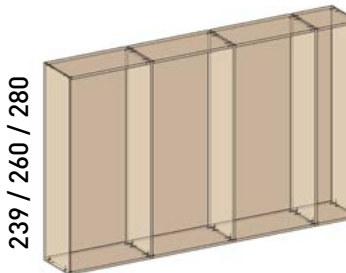

Altura	Ref.	Puntos
239	ARB394	933
260	ARB396	1064
280	ARB398	1130

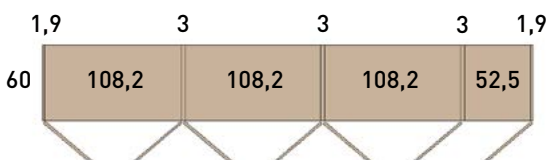

Puertas iguales de 55,4

400

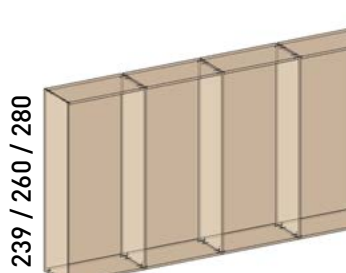

Altura	Ref.	Puntos
239	ARB404	960
260	ARB406	1096
280	ARB408	1159

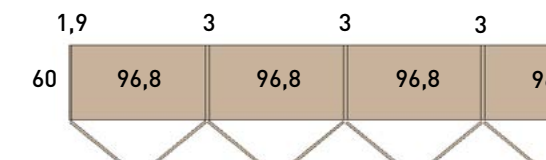

Puertas iguales de 49,7

410

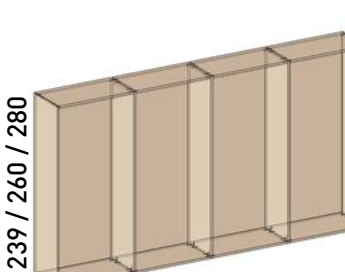

Altura	Ref.	Puntos
239	ARB414	989
260	ARB416	1125
280	ARB418	1190

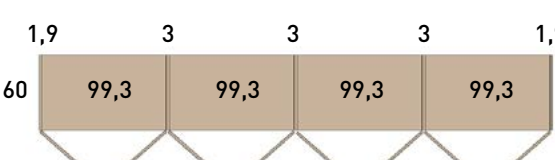

Puertas iguales de 51

420

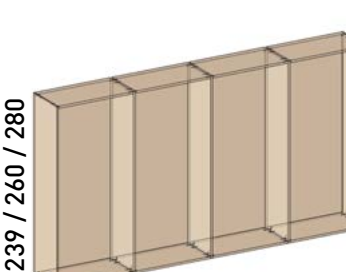

Altura	Ref.	Puntos
239	ARB424	1007
260	ARB426	1150
280	ARB428	1220

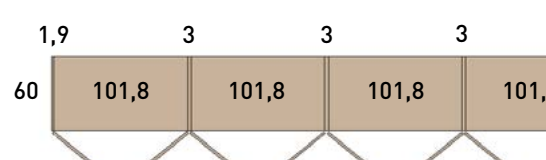

Puertas iguales de 52,2

Puertas para armarios batientes en pág. 31. Complementos interior en pág 51.

Para cajas de armario con RAIL SYSTEM complementos interior en pág 67.

Para medidas intermedias, coger referencia de medida superior y cortar sin incremento (largo, alto y fondo)

430

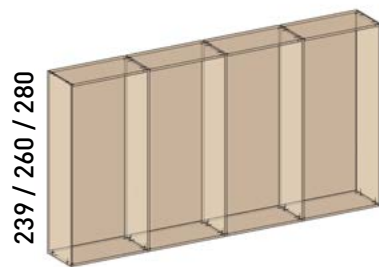

239 / 260 / 280

Altura	Ref.	Puntos
239	ARB434	1035
260	ARB436	1179
280	ARB438	1251

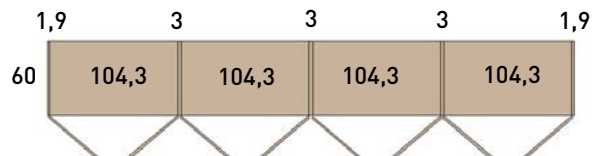

Puertas iguales de 53,5

440

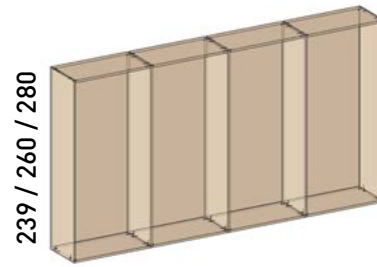

239 / 260 / 280

Altura	Ref.	Puntos
239	ARB444	1068
260	ARB446	1216
280	ARB448	1289

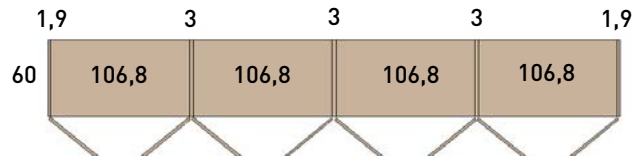

Puertas iguales de 54,7

450

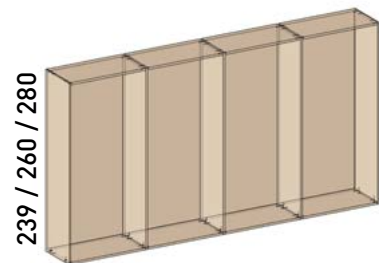

239 / 260 / 280

Altura	Ref.	Puntos
239	ARB454	1101
260	ARB456	1252
280	ARB458	1327

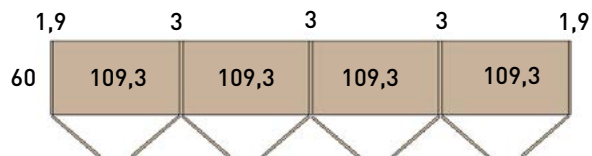

Puertas iguales de 56

460

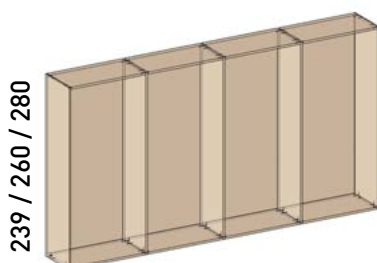

239 / 260 / 280

Altura	Ref.	Puntos
239	ARB464	1134
260	ARB466	1288
280	ARB468	1365

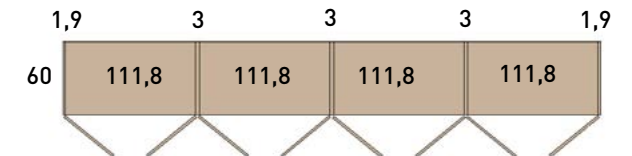

Puertas iguales de 57,2

470

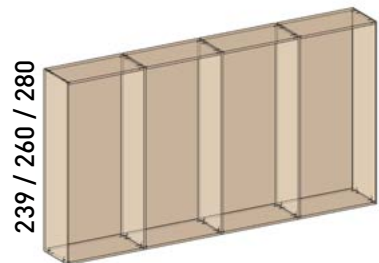

239 / 260 / 280

Altura	Ref.	Puntos
239	ARB474	1167
260	ARB476	1325
280	ARB478	1403

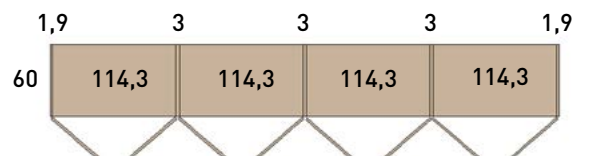

Puertas iguales de 58,5

480

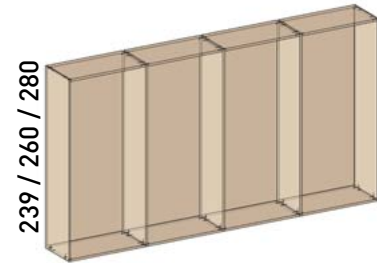

239 / 260 / 280

Altura	Ref.	Puntos
239	ARB484	1200
260	ARB486	1361
280	ARB488	1441

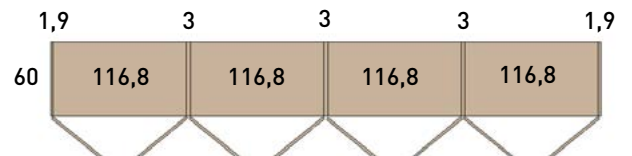

Puertas iguales de 59,7

Puertas para armarios batientes en pág. 31. Complementos interior en pág 51.

Para cajas de armario con RAIL SYSTEM complementos interior en pág 67.

Para medidas intermedias, coger referencia de medida superior y cortar sin incremento (largo, alto y fondo)

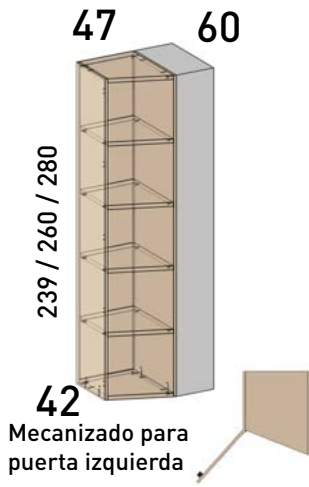

Equipado con 4 estantes.

Altura	Ref.	Puntos
239	ART41Z	288
260	ART61Z	316
280	ART81Z	330

Medidas especiales consultar con fábrica.
Tirador Toca-Toca no compatible.

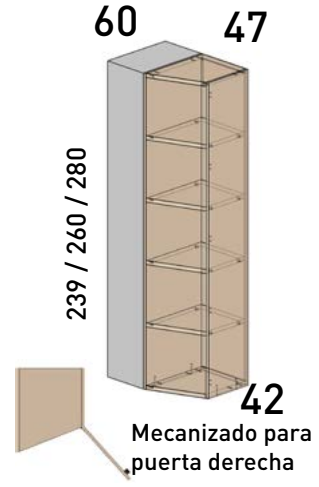

Equipado con 4 estantes.

Altura	Ref.	Puntos
239	ART41D	288
260	ART61D	316
280	ART81D	330

Medidas especiales consultar con fábrica.
Tirador Toca-Toca no compatible.

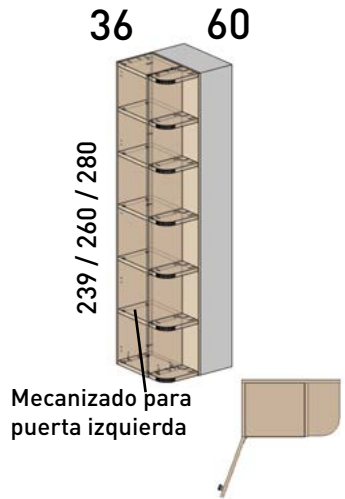

Altura	Ref.	Puntos
239	ART42Z	341
260	ART62Z	374
280	ART82Z	387

Mecanizado para puerta izquierda

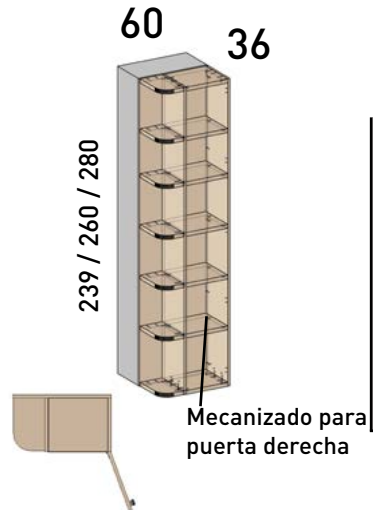

Altura	Ref.	Puntos
239	ART42D	341
260	ART62D	374
280	ART82D	387

Mecanizado para puerta derecha

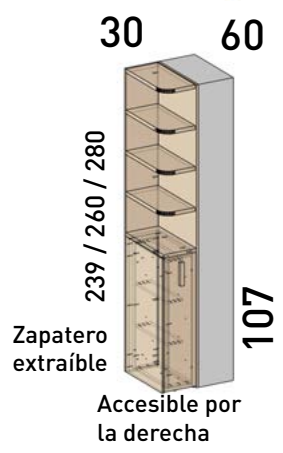

Altura	Ref.	Puntos
239	ART43Z	377
260	ART63Z	406
280	ART83Z	425

Zapatero extraíble

Accesible por la derecha

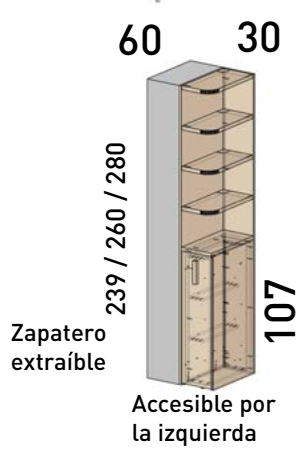

Altura	Ref.	Puntos
239	ART43D	377
260	ART63D	406
280	ART83D	425

Zapatero extraíble

Accesible por la izquierda

Tirador Matri y Toca-Toca no compatible.

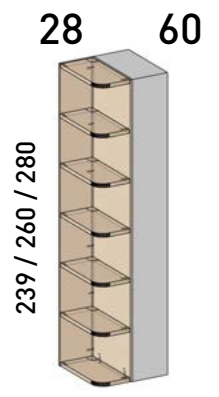

Altura	Ref.	Puntos
239	ART44Z	306
260	ART64Z	327
280	ART84Z	341

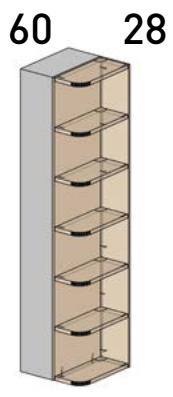

Altura	Ref.	Puntos
239	ART44D	306
260	ART64D	327
280	ART84D	341

Puertas para armarios batientes en pág. 31.

Para medidas intermedias, coger referencia de medida superior y cortar sin incremento (largo, alto y fondo)

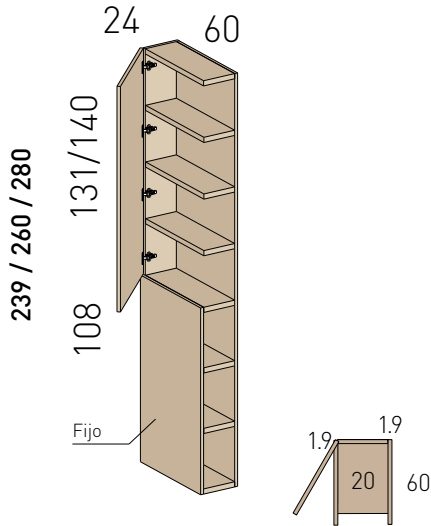

Altura	Ref.	Puntos
239	ART45Z	228
260	ART65Z	250
280	ART85Z	264

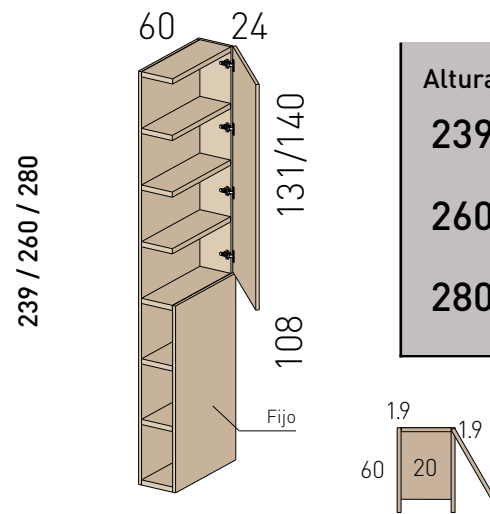

Altura	Ref.	Puntos
239	ART45D	228
260	ART65D	250
280	ART85D	264

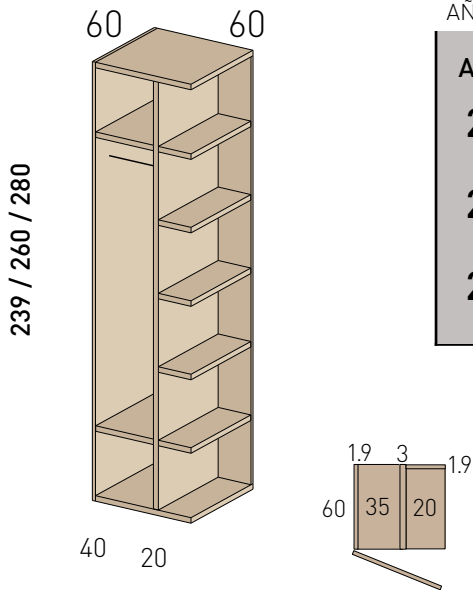

AÑADIR PUERTA

Altura	Ref.	Puntos
239	ART47Z	319
260	ART67Z	350
280	ART87Z	369

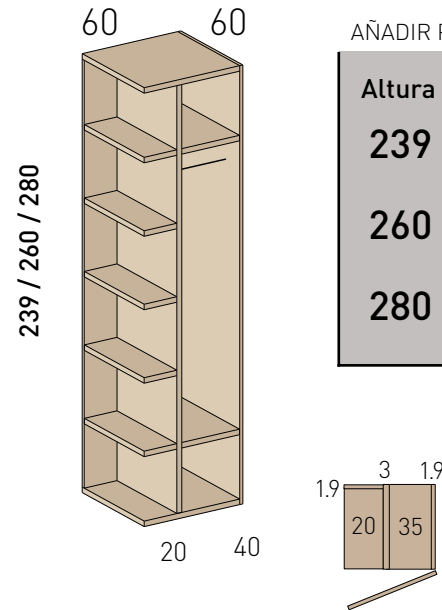

AÑADIR PUERTA

Altura	Ref.	Puntos
239	ART47D	319
260	ART67D	350
280	ART87D	369

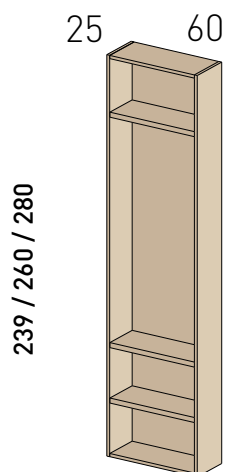

Altura	Ref.	Puntos
239	ART48	204
260	ART68	225
280	ART88	238

Puertas para armarios batientes en pág. 31. Complementos interior en pág 51.

Para cajas de armario con RAIL SYSTEM complementos interior en pág 69.

Para medidas intermedias, coger referencia de medida superior y cortar sin incremento (largo, alto y fondo)

VESTIDOR LOUNGE

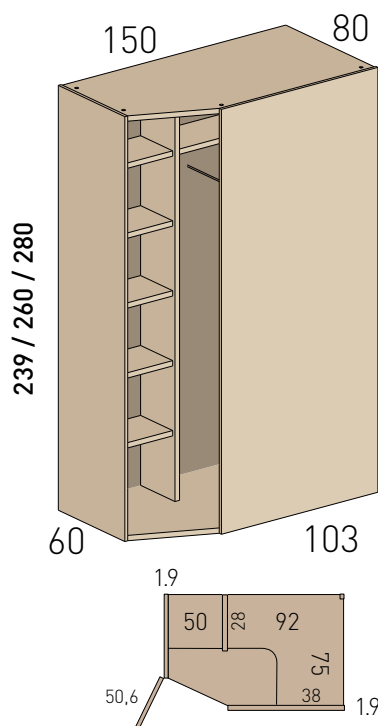

Altura	Ref.	Puntos
239	AV4Z	720
260	AV6Z	768
280	AV8Z	821

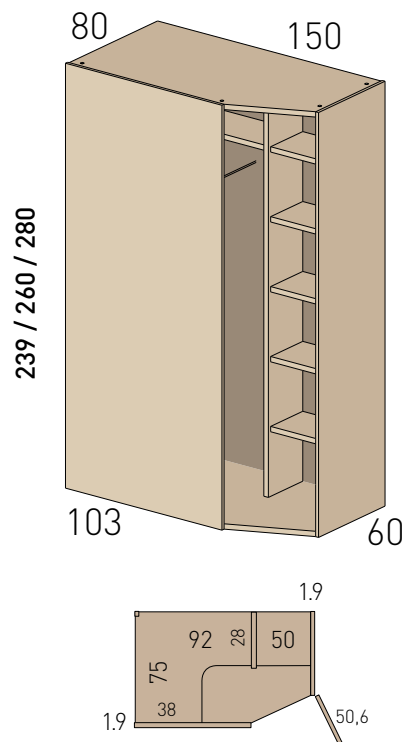

Altura	Ref.	Puntos
239	AV4D	720
260	AV6D	768
280	AV8D	821

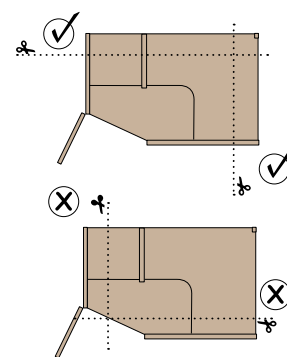

CARACTERÍSTICAS ESPECÍFICAS

Armario vestidor tipo cabina con estantería interior de 5 estantes y barra de colgar recta. Bisagras con cierre amortiguado. Especiales en altura, fondo y largo sin modificar medidas de puerta.

No compatible con puertas enmarcadas modelo AIR.

ARMARIO RINCÓN

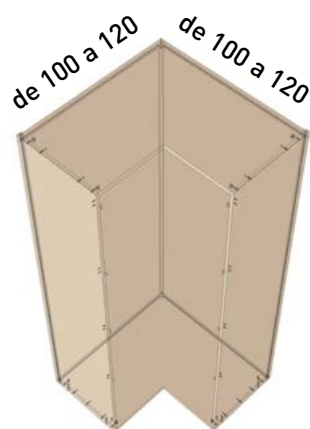

Altura	Ref.	Puntos
239	AR4	440
260	AR6	499
280	AR8	532

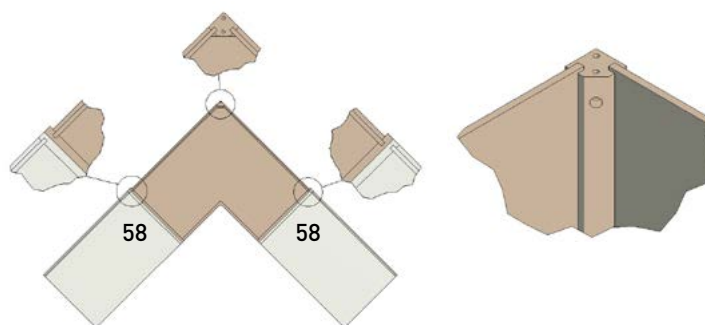

MONTAJE ARMARIO RINCÓN

Para montar un armario de rincón en un hueco es necesario disponer de **5cm** libres para su montaje lateral, y de **5cm** libres para su montaje superior.

CARACTERÍSTICAS ESPECÍFICAS

Solo un tirador en puerta izquierda.

Tirador Toca-Toca no compatible con las puertas de este armario.

No compatible con puertas enmarcadas modelo AIR.

Puertas para armarios batientes en pág. 31. Complementos interior en pág 51.

Para cajas de armario con RAIL SYSTEM complementos interior en pág 69.

Para medidas intermedias, coger referencia de medida superior y cortar sin incremento (largo, alto y fondo)

ARMARIO CHAFLÁN

PARTIDOR INTERIOR INCLUIDO

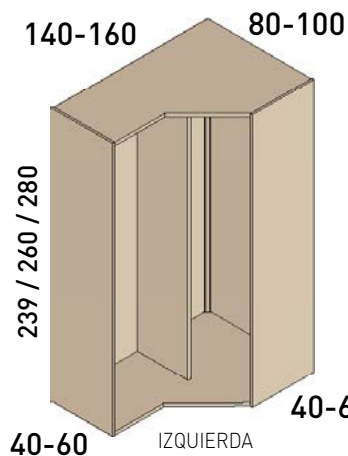

Altura	Ref.	Puntos
239	ARC4Z	534
260	ARC6Z	592
280	ARC8Z	637

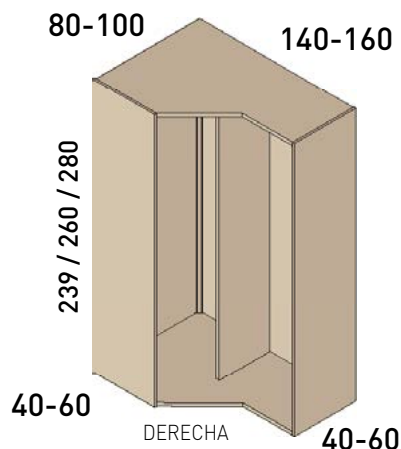

Altura	Ref.	Puntos
239	ARC4D	534
260	ARC6D	592
280	ARC8D	637

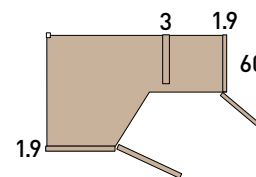
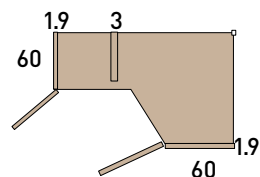

EJEMPLOS MONTAJES INTERIORES

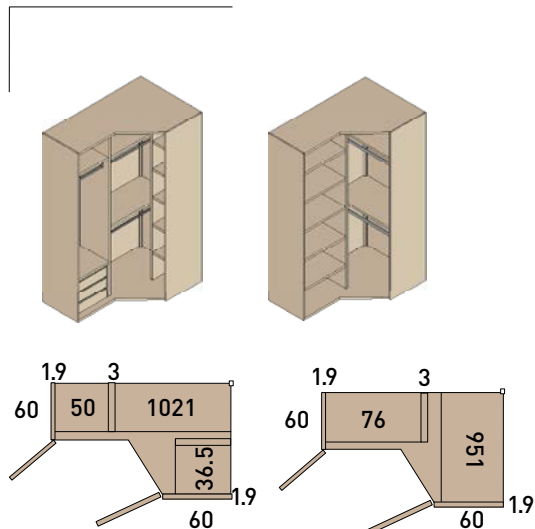

ESPECIALES SIN MODIFICAR PUERTA 1

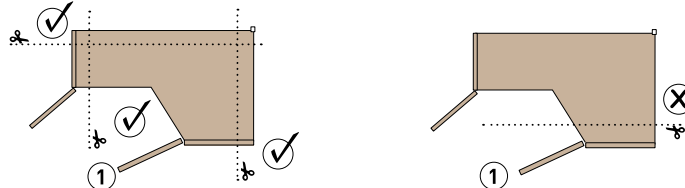

MONTAJE ARMARIO RINCÓN

Es necesario disponer de **5cm** libres para su montaje lateral, y de **5cm** libres para su montaje superior.

CARACTERÍSTICAS ESPECÍFICAS

- Tirador Toca-Toca no compatible
- Puertas AIR, Craft, Craft Madera no compatibles
- Cajoneras con 3 cm de regreso para salvar visagra
- Opcionalmente se puede reducir el partidor

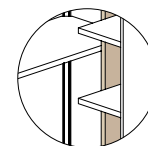

EJEMPLO SELECCIÓN DE PUERTAS

El cliente desea unas puertas para un armario de 175 cm, de 239 cm de altura

Buscar las puertas deseadas y acabados, en este caso elegimos las lisas, con su color y su altura correspondiente.



Altura		Acabados BASE		Acabados STONE	
		Ref	Puntos	Ref	Puntos
239	DR	PJA4D	68	PSA4D	75
	IZ	PJA4Z	68	PSA4Z	75
260	DR	PJA6D	74	PSA6D	81
	IZ	PJA6Z	74	PSA6Z	81
280	DR	PJA8D	78	PSA8D	86
	IZ	PJA8Z	78	PSA8Z	86

Altura máxima
acabado STONE
277cm

Que características tiene las puertas y cual es su valor en puntos.

Tenemos 4 referencias (dos por cuerpo): **2 PJA4D** y **2 PJA4Z** todas iguales adaptadas al armario de 175.

No hay incremento en los puntos por modificar las puertas, por eso su valor es **272 puntos** (las 4 puertas).

En cada puerta aparecen los posibles tiradores combinables en esa puerta y si existe incremento.

En resumen: Sólo se tiene que elegir **2 PJA4D** y **2 PJA4Z** para caja de **175cm** con tirador Ark y jotajotape se encarga del resto.

Lisas



Ancho máximo de puerta 60 cm.

Altura		Acabados BASE		Acabados STONE	
		Ref	Puntos	Ref	Puntos
239	DR	PJA4D	68	PSA4D	75
	IZ	PJA4Z	68	PSA4Z	75
260	DR	PJA6D	74	PSA6D	81
	IZ	PJA6Z	74	PSA6Z	81
280	DR	PJA8D	78	PSA8D	86
	IZ	PJA8Z	78	PSA8Z	86



Detalle puerta

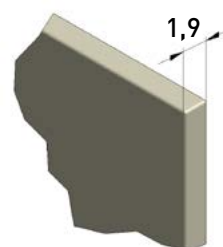

Altura máxima acabado STONE 277cm

Acabados STONE canteados con PVC de 0.8mm



No se recomienda 2 TESTA a igual altura

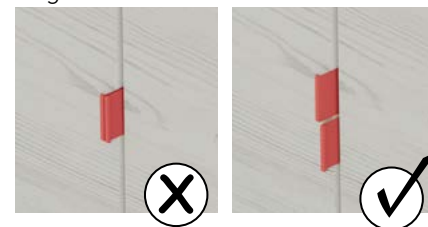

Tiradores

				Toca-Toca superficie 			
Belt	Anello	Ark largo	Dito		Testa 3/20/30/40/50/70cm	Testa 100	Testa Total
+0	+0	+8	+0	+8	+0	+6	+20

Acabados Tiradores



Rústica





Ancho máximo de puerta 60 cm.



Dos ranuras de 2 mm de ancho por puerta.

 **INCREMENTO POR RANURA ADICIONAL +7**

		Acabados BASE		Acabados STONE	
		Ref	Puntos	Ref	Puntos
239	DR	PJB4D	88	PSB4D	95
	IZ	PJB4Z	88	PSB4Z	95
260	DR	PJB6D	92	PSB6D	99
	IZ	PJB6Z	92	PSB6Z	99
280	DR	PJB8D	96	PSB8D	104
	IZ	PJB8Z	96	PSB8Z	104
Acabados					

Detalle puerta

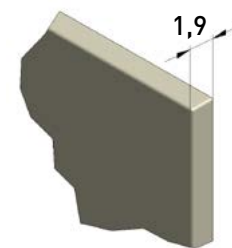

Altura máxima acabado STONE 277cm
Acabados STONE canteados con PVC de 0.8mm







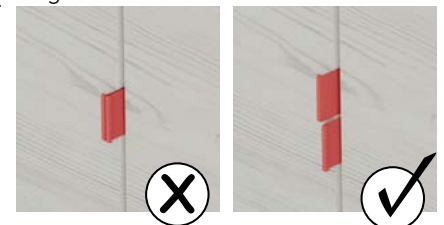

Definir acabados ranuras



 No se recomienda 2 TESTA a igual altura



Tiradores

				Toca-Toca superficie 			
Belt	Anello	Ark largo	Dito		Testa 3/20/30/40/50/70cm	Testa 100	Testa Total
+0	+0	+8	+0	+8	+0	+6	+20



ONIX



Ancho máximo de puerta 60 cm.

Altura		Acabados BASE		Acabados STONE	
		Ref	Puntos	Ref	Puntos
239	DR	PJC4D	96	PSC4D	103
	IZ	PJC4Z	96	PSC4Z	103
260	DR	PJC6D	102	PSC6D	109
	IZ	PJC6Z	102	PSC6Z	109
280	DR	PJC8D	106	PSC8D	114
	IZ	PJC8Z	106	PSC8Z	114



Detalle puerta

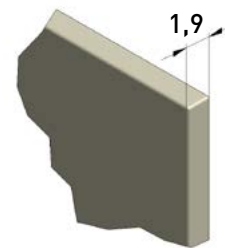

Altura máxima acabado STONE 277cm

Acabados STONE canteados con PVC de 0.8mm

Único TIRADOR incorporado

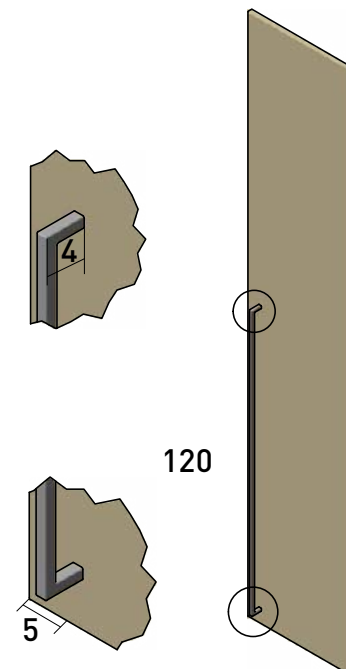

Neo



Ancho máximo de puerta 60 cm.

Altura		Acabados BASE		Acabados STONE	
		Ref	Puntos	Ref	Puntos
239	DR	PJD4D	76	PSD4D	83
	IZ	PJD4Z	76	PSD4Z	83
260	DR	PJD6D	82	PSD6D	89
	IZ	PJD6Z	82	PSD6Z	89
280	DR	PJD8D	86	PSD8D	94
	IZ	PJD8Z	86	PSD8Z	94

Acabados



Detalle puerta

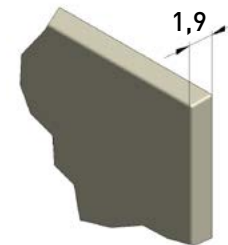

Altura máxima acabado STONE 277cm

Acabados STONE canteados con PVC de 0.8mm

Único TIRADOR incorporado

Acabados Tiradores

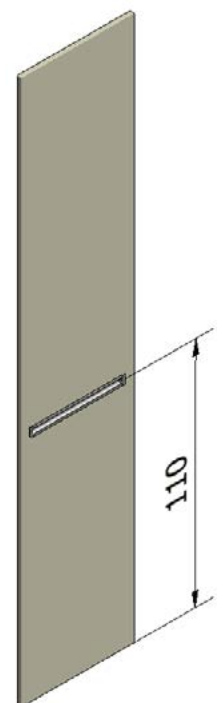
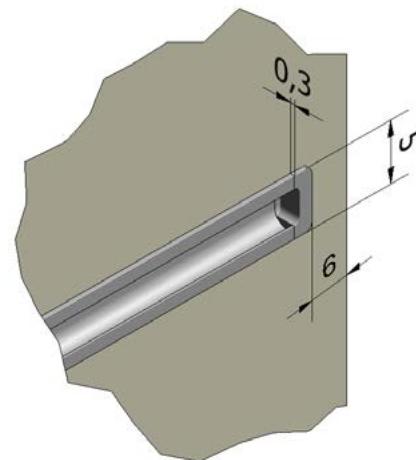

Matri



Ancho máximo de puerta 60 cm.

Altura		Acabados BASE		Acabados STONE	
		Ref	Puntos	Ref	Puntos
239	DR	PJE4D	108	PSE4D	115
	IZ	PJE4Z	108	PSE4Z	115
260	DR	PJE6D	116	PSE6D	123
	IZ	PJE6Z	116	PSE6Z	123
280	DR	PJE8D	121	PSE8D	129
	IZ	PJE8Z	121	PSE8Z	129

Acabados



Detalle puerta

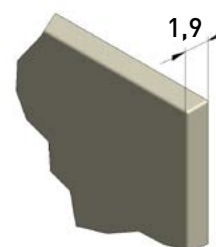

Altura máxima acabado STONE 277cm

Acabados STONE canteados con PVC de 0.8mm

Único TIRADOR incorporado

Acabados Tiradores



No se recomienda 2 tiradores MATRI consecutivos

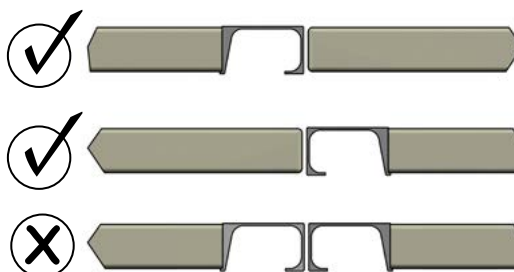

Combinar una puerta Matri con una puerta lisa

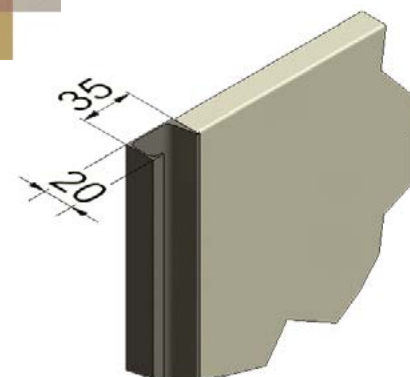

Craft



Ancho máximo de puerta 60 cm.

Altura		Acabados BASE		Acabados STONE	
		Ref	Puntos	Ref	Puntos
239	DR	PJG4D	148	PSG4D	155
	IZ	PJG4Z	148	PSG4Z	155
260	DR	PJG6D	154	PSG6D	161
	IZ	PJG6Z	154	PSG6Z	161
280	DR	PJG8D	158	PSG8D	166
	IZ	PJG8Z	158	PSG8Z	166
Acabados					

Detalle puerta

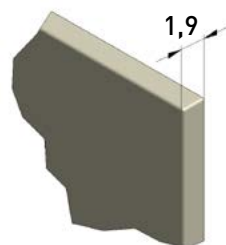

Altura máxima acabado STONE 277cm

Acabados STONE canteados con PVC de 0.8mm

Único TIRADOR incorporado

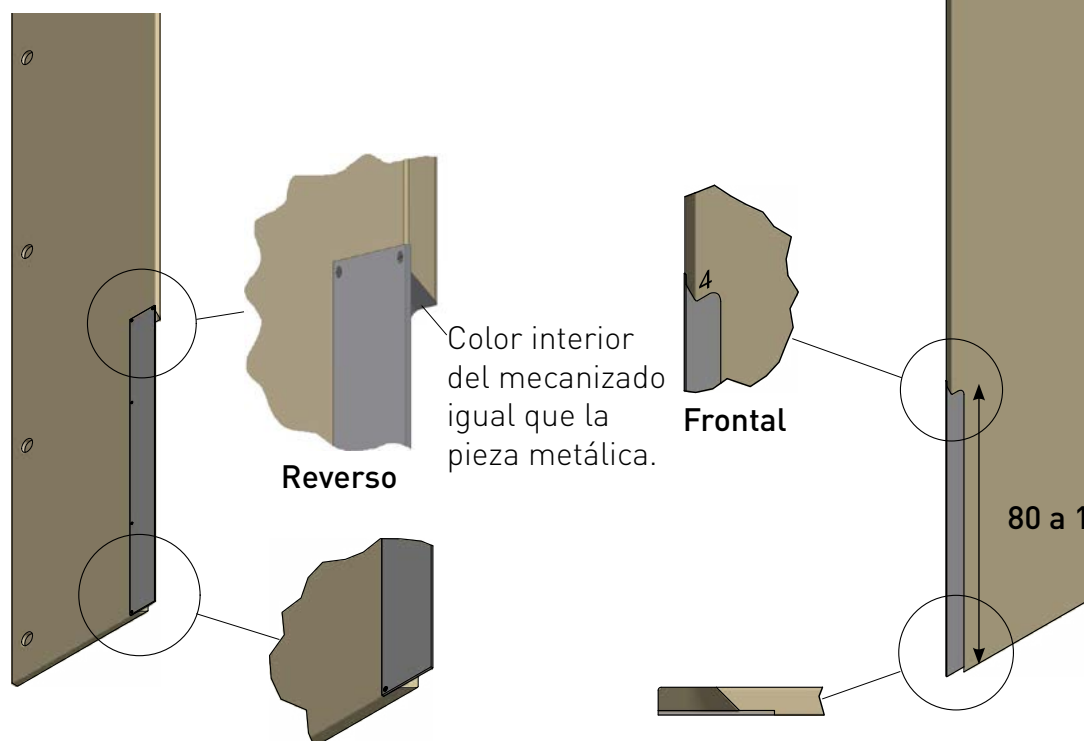

! Altura de tirador variable entre 80 y 160cm. Por defecto altura 90cm. No se puede modificar el ancho del tirador

Semi



Ancho máximo de puerta 60 cm.

Altura		Acabados BASE		Acabados STONE	
		Ref	Puntos	Ref	Puntos
239	DR	PJF4D	76	PSF4D	83
	IZ	PJF4Z	72	PSF4Z	79
260	DR	PJF6D	82	PSF6D	89
	IZ	PJF6Z	78	PSF6Z	85
280	DR	PJF8D	85	PSF8D	93
	IZ	PJF8Z	81	PSF8Z	89



Detalle puerta

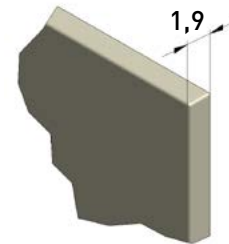

Altura máxima acabado STONE 277cm

Acabados STONE canteados con PVC de 0.8mm

Único TIRADOR incorporado

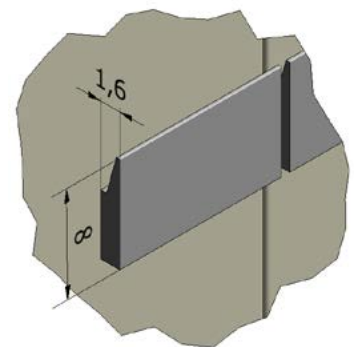
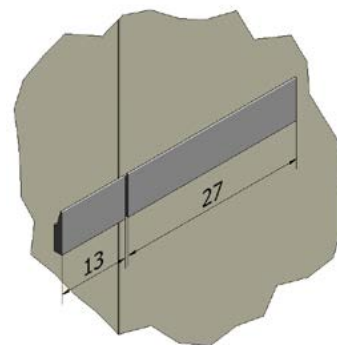

Iris



Ancho máximo de puerta 60 cm.

Altura		Acabados BASE		Acabados STONE	
		Ref	Puntos	Ref	Puntos
239	DR	PJH4D	106	PSH4D	113
	IZ	PJH4Z	106	PSH4Z	113
260	DR	PJH6D	114	PSH6D	121
	IZ	PJH6Z	114	PSH6Z	121
280	DR	PJH8D	119	PSH8D	127
	IZ	PJH8Z	119	PSH8Z	127
Acabados					

Detalle puerta

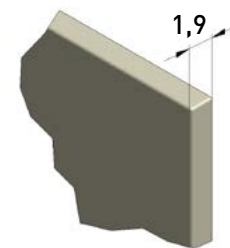

Altura máxima acabado STONE 277cm

Acabados STONE canteados con PVC de 0.8mm

Único TIRADOR incorporado

Acabados Tirador

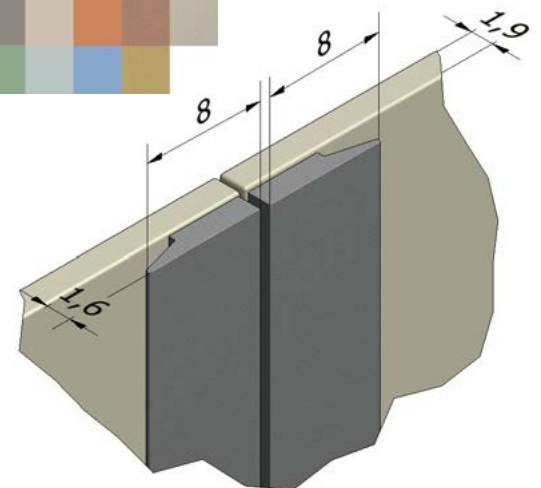

Iris Centro



Ancho máximo de puerta 60 cm.

Altura		Acabados BASE		Acabados STONE	
		Ref	Puntos	Ref	Puntos
239	DR	PJT4D	106	PST4D	113
	IZ	PJT4Z	106	PST4Z	113
260	DR	PJT6D	114	PST6D	119
	IZ	PJT6Z	114	PST6Z	119
280	DR	PJT8D	119	PST8D	127
	IZ	PJT8Z	119	PST8Z	127

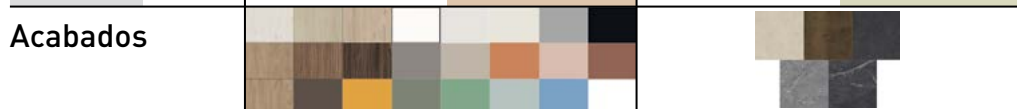

Detalle puerta

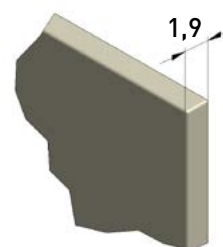

Altura máxima acabado STONE 277cm

Acabados STONE canteados con PVC de 0.8mm

Único TIRADOR incorporado

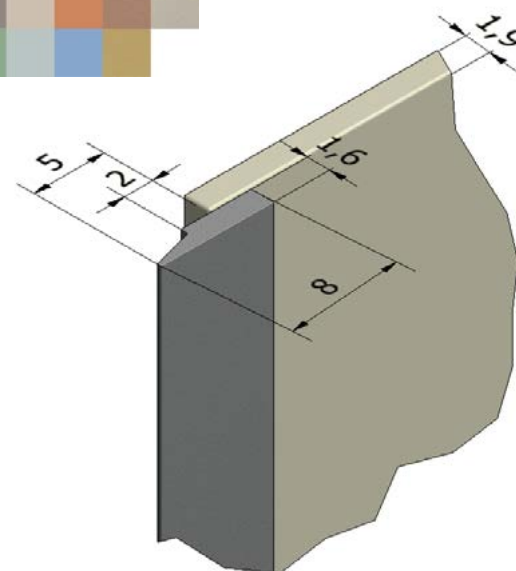

Combinar una puerta IRIS Centro con una puerta lisa

Vertical 115



Ancho máximo de puerta 60 cm.

Altura		Acabados BASE		Acabados STONE	
		Ref	Puntos	Ref	Puntos
239	DR	PJJ4D	83	PSJ4D	90
	IZ	PJJ4Z	83	PSJ4Z	90
260	DR	PJJ6D	89	PSJ6D	96
	IZ	PJJ6Z	89	PSJ6Z	96
280	DR	PJJ8D	92	PSJ8D	100
	IZ	PJJ8Z	92	PSJ8Z	100

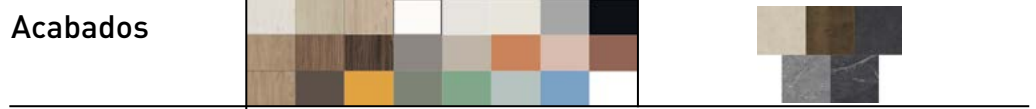

Detalle puerta

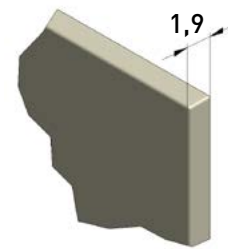

Altura máxima acabado STONE 277cm
Acabados STONE canteados con PVC de 0.8mm

Único TIRADOR incorporado

Acabados Tirador

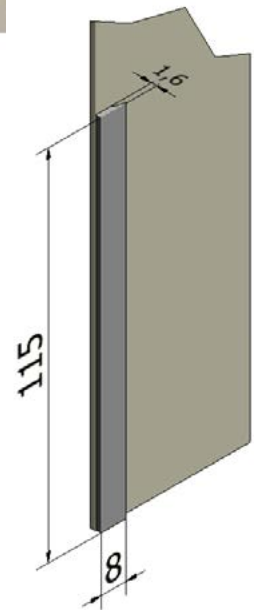

Relief

Relief 10cm



Ancho máximo de puerta 60 cm.

		Acabados BASE	
Altura		Ref	Puntos
239	DR	PJK4D	102
	IZ	PJK4Z	102
260	DR	PJK6D	110
	IZ	PJK6Z	110
280	DR	PJK8D	116
	IZ	PJK8Z	116
Acabados			

Detalle puerta

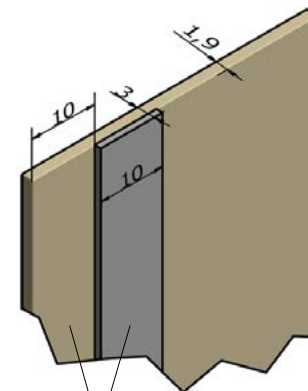

* Medidas fijas

Relief 20cm



Ancho máximo de puerta 60 cm.

		Acabados BASE	
Altura		Ref	Puntos
239	DR	PJL4D	112
	IZ	PJL4Z	112
260	DR	PJL6D	120
	IZ	PJL6Z	120
280	DR	PJL8D	126
	IZ	PJL8Z	126
Acabados			

Detalle puerta

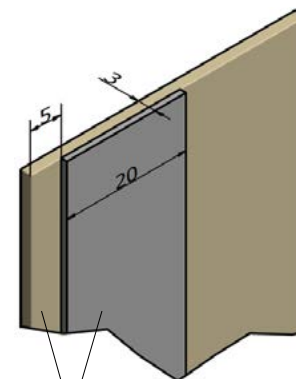

* Medidas fijas

Acabados Franja



Acabados STONE para franja incremento +5 puntos alto máximo 277

Tiradores

Toca-Toca superficie 	Testa 3/20/30/40/50/70cm 	Testa 100 	TestaTotal
+8	+0	+6	+20

Acabados Tiradores



Enmarcada aluminio 1 plafón

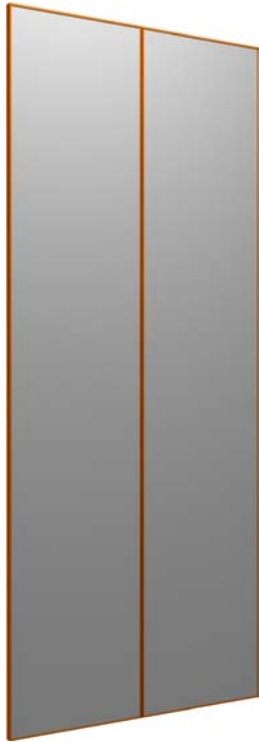

Ancho máximo de puerta 60 cm.

Ancho máximo de puerta 60 cm.

Altura		Acabados BASE		Acabados STONE	
		Ref	Puntos	Ref	Puntos
239	DR	PJM4D	130	PSM4D	137
	IZ	PJM4Z	130	PSM4Z	137
260	DR	PJM6D	140	PSM6D	147
	IZ	PJM6Z	140	PSM6Z	147
280	DR	PJM8D	145	PSM8D	153
	IZ	PJM8Z	145	PSM8Z	153
Acabados					

Detalle puerta

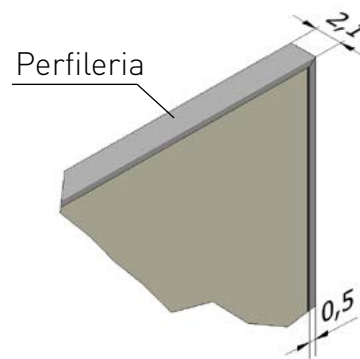

Altura máxima acabado STONE 277cm

Acabados Perfil



Tiradores

Belt	Anello	Ark largo	Dito	Toca-Toca superficie	Testa 3/20/30/40/50/70cm	Testa 100	Testa Total
+0	+0	+8	+0	+8	+0	+6	+20

Acabados Tiradores



Enmarcada aluminio 3 plafones IGUALES



Ancho máximo de puerta 60 cm.

Altura		Acabados BASE		Acabados STONE	
		Ref	Puntos	Ref	Puntos
239	DR	PJN4D	133	PSN4D	140
	IZ	PJN4Z	133	PSN4Z	140
260	DR	PJN6D	143	PSN6D	150
	IZ	PJN6Z	143	PSN6Z	150
280	DR	PJN8D	148	PSN8D	156
	IZ	PJN8Z	148	PSN8Z	156
Acabados					

Detalle puerta

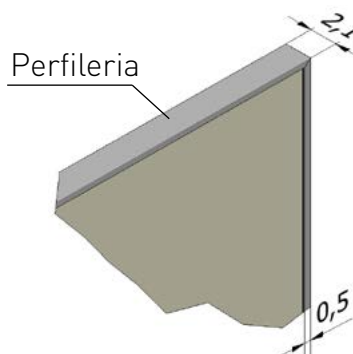

Altura máxima acabado STONE 277cm

Acabados Perfil



Tiradores

Belt	Anello	Ark largo	Dito	Toca-Toca superficie	Testa 3/20/30/40/50/70cm	Testa 100	TestaTotal
+0	+0	+8	+0	+8	+0	+6	+20

Acabados Tiradores



Enmarcada aluminio 3 plafones COMBINABLES



Ancho máximo de puerta 60 cm.

		Acabados BASE	
Altura		Ref	Puntos
239	DR	PJV4D	160
	IZ	PJV4Z	160
260	DR	PJV6D	172
	IZ	PJV6Z	172
280	DR	PJV8D	181
	IZ	PJV8Z	181



Acabados combinables especificar posición

Detalle puerta

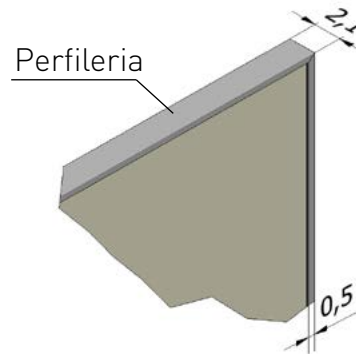

Acabados Perfil



Tiradores

Belt	Anello	Ark largo	Dito	Toca-Toca superficie	Testa 3/20/30/40/50/70cm	Testa 100	Testa Total
+0	+0	+8	+0	+8	+0	+6	+20

Acabados Tiradores



Desigual (ancho diferente)



Ancho máximo de puerta 60 cm.

Altura		Acabados BASE	
		Ref	Puntos
239	DR	PJP4D	140
	IZ	PJP4Z	140
260	DR	PJP6D	152
	IZ	PJP6Z	152
280	DR	PJP8D	160
	IZ	PJP8Z	160
Acabados			





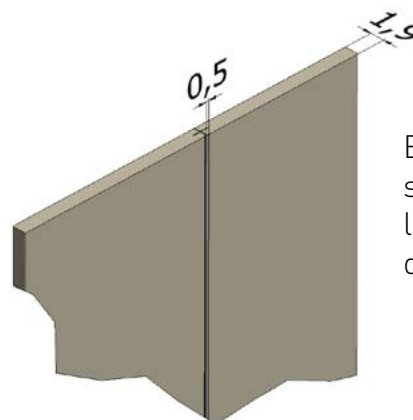



Acabados combinables especificar posición

Detalle puerta

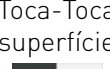

El tirador siempre va en la parte ancha de la puerta

Tiradores

							
Belt	Anello	Ark largo	Dito	Toca-Toca superficie	Testa 3/20/30/40/50/70cm	Testa 100	TestaTotal
+0	+0	+8	+0	+8	+0	+6	+20

Acabados Tiradores



Enmarcada LUX

No recomendamos combinar con otros modelos de puertas enmarcadas.



Ancho máximo de puerta 60 cm.

Altura		Acabados CRISTAL		Acabados BASE		Acabados STONE	
		Ref	Puntos	Ref	Puntos	Ref	Puntos
239	DR	PVQ4D	330	PJQ4D	200	PSQ4D	207
	IZ	PVQ4Z	330	PJQ4Z	200	PSQ4Z	207
260	DR	PVQ6D	350	PJQ6D	212	PSQ6D	219
	IZ	PVQ6Z	350	PJQ6Z	212	PSQ6Z	219
280	DR	PVQ8D	370	PJQ8D	224	PSQ8D	232
	IZ	PVQ8Z	370	PJQ8Z	224	PSQ8Z	232
Acabados							

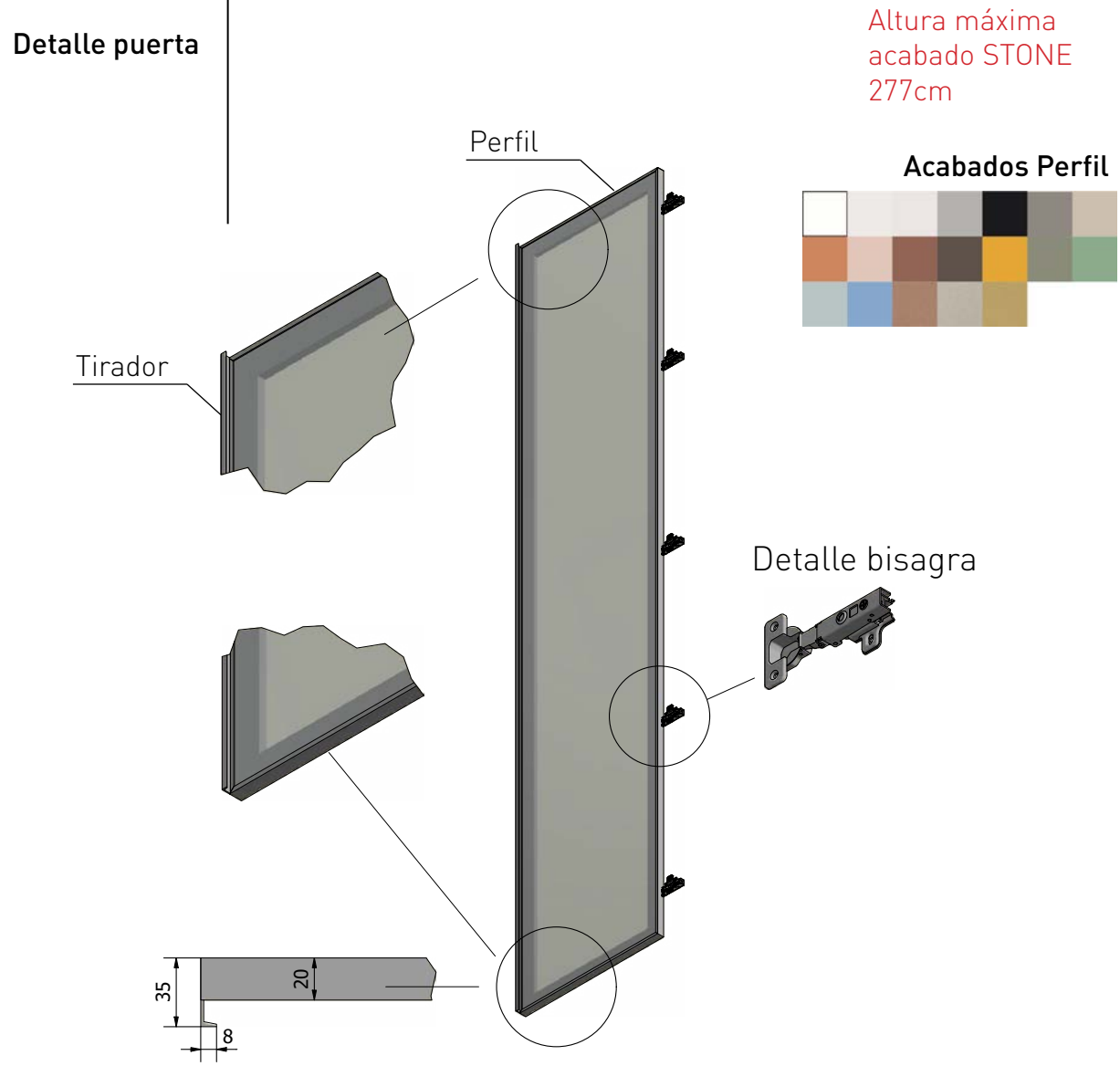

Único TIRADOR incorporado

Enmarcada AIR

No recomendamos combinar con otros modelos de puertas enmarcadas.



Ancho máximo de puerta 60 cm.

Altura		Acabados CRISTAL		Acabados BASE		Acabados STONE	
		Ref	Puntos	Ref	Puntos	Ref	Puntos
239	DR	PVR4D	378	PJR4D	248	PSR4D	255
	IZ	PVR4Z	378	PJR4Z	248	PSR4Z	255
Acabados							

Detalle puerta

Acabados Perfil

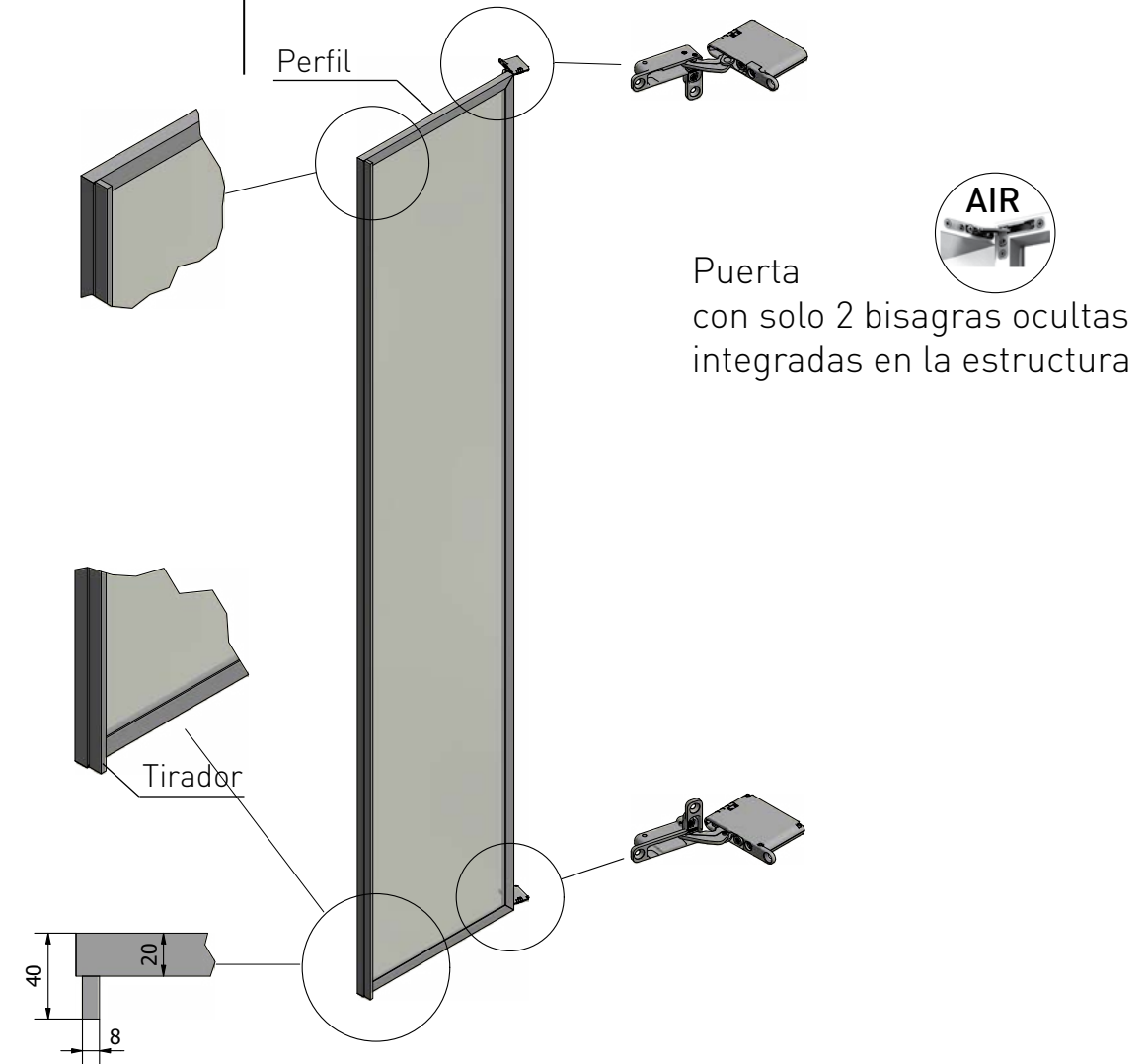

Único TIRADOR incorporado

VALORACIÓN PUERTAS DIMENSIÓN REDUCIDA

Para calcular el precio de las puertas se tiene que aplicar un descuento a los puntos de estas. Este descuento es proporcional a la altura de la puerta.

**IMPRESCINDIBLE
enviar dibujo**

Altura puerta	Modelo AIR Descuento	Modelo LUX Descuento	Resto Modelos Descuento	Modelo Craft Descuento
de 30 a 72	40%	50%	60%	30%
de 72,1 a 108	30%	40%	50%	20%
de 108,1 a 150	20%	30%	40%	15%
de 150,1 a 190	10%	10%	20%	8%
de 190,1 a 220	0%	5%	10%	5%



Dibujo ejemplo 1:

Ref.	Altura puerta	Puntos Tarifa	Descuento	Puntos
ARB54D Caja armario 50		187		187
2 x ET65 Estante		25		50
PJA4D Puerta lisa derecha	82cm	68	50%	34
PJA4D Puerta lisa derecha	82cm	68	50%	34
				305

Dibujo ejemplo 2:



Ref.	Altura puerta	Puntos Tarifa	Descuento	Puntos
ARB88 Caja armario 80		278		278
4xET68 Estante		4 x 32		128
PJM4D Puerta Enm. dch	40cm	130	60%	52
PJM4Z Puerta Enm. izq	40cm	130	60%	52
PJM4D Puerta Enm. dch	80cm	130	50%	65
PJM4Z Puerta Enm. izq	80cm	130	50%	65
PJM4D Puerta Enm. dch	80cm	130	50%	65
PJM4Z Puerta Enm. izq	80cm	130	50%	65
				770

Craft Madera

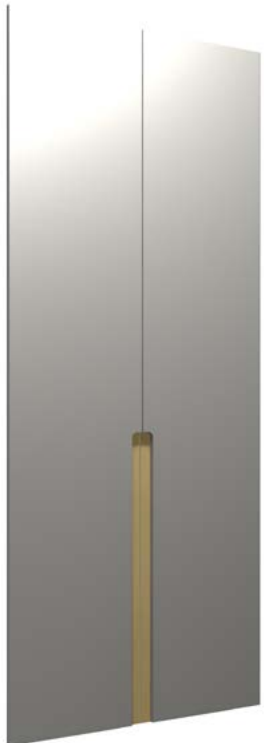

Ancho máximo de puerta 60 cm.

		Acabados BASE		Acabados STONE	
Altura		Ref	Puntos	Ref	Puntos
239	DR	PJX4D	148	PSX4D	155
	IZ	PJX4Z	148	PSX4Z	155
260	DR	PJX6D	154	PSX6D	161
	IZ	PJX6Z	154	PSX6Z	161
280	DR	PJX8D	158	PSX8D	166
	IZ	PJX8Z	158	PSX8Z	166
Acabados					

Detalle puerta

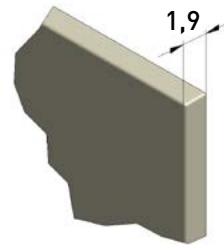

Altura máxima acabado STONE 277cm

Acabados STONE canteados con PVC de 0.8mm

Único TIRADOR incorporado

Único color Roble Claro 

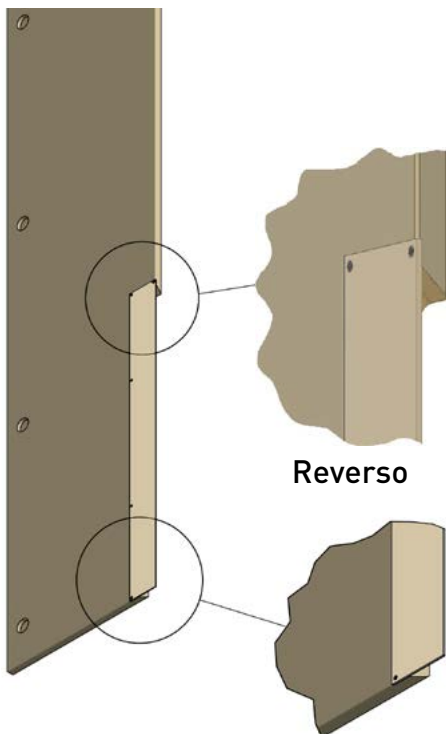

Reverso

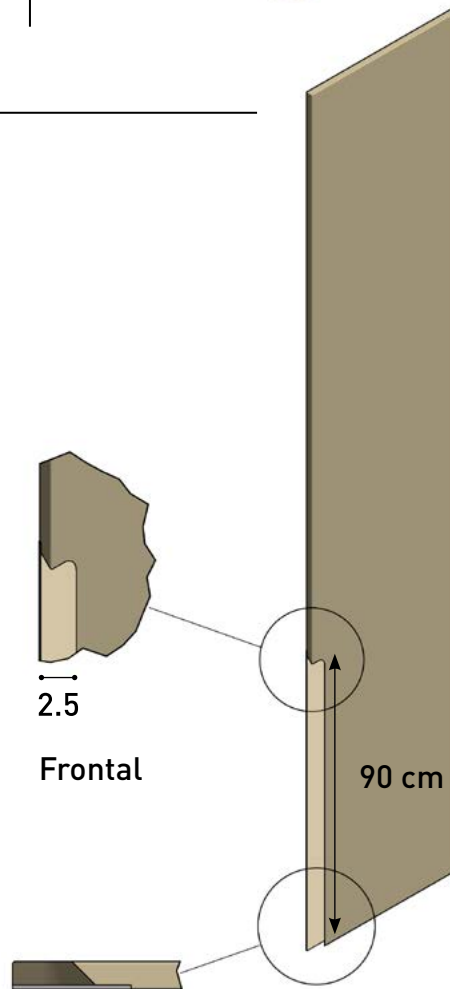

Frontal

90 cm



Altura fija 90cm
2,5cm de alcho

EJEMPLO ELECCIÓN DE INTERIORES

Deseamos añadir 2 estantes, una barra de colgar y una cajonera al interior de un armario de 95 cm, de 239 cm de altura.

Buscar las opciones de interior deseadas para un hueco interior de 91,2.

Al modificar el armario de 100 a 95 las medidas de hueco son 91,2.

Ref.	Puntos
ET60	34
ET60	34
BC10	28
CG2110	174

Las opciones de interior se adaptan a la medida exacta del hueco interior.

No hay incremento en los puntos por recortar las opciones, son un total de **271 puntos**.

OPCIONES PARA ARMARIOS BATIENTES

ESTANTES FONDO 55,8



Ref.	ET64	ET65	ET66	ET68
Puntos	22	25	29	32



Ref.	ET60	ET62
Puntos	34	39

ESTANTES EXTRAIBLE FONDO 55,8

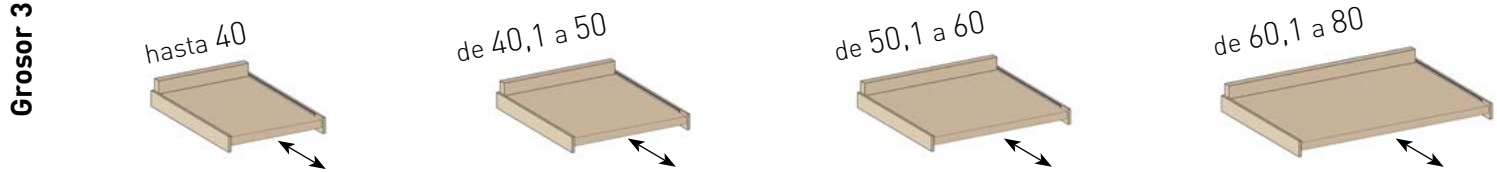

Ref.	ETT64	ETT65	ETT66	ETT68
Puntos	54	57	61	64

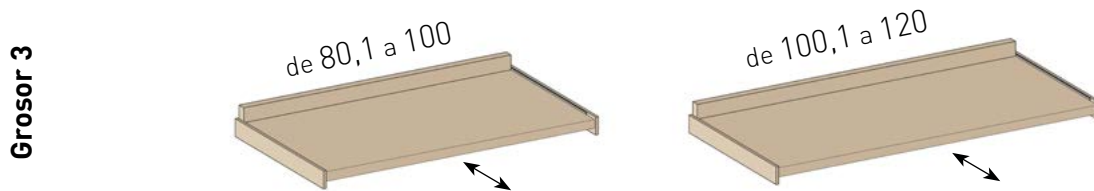

Ref.	ETT60	ETT62
Puntos	66	71

BARRAS

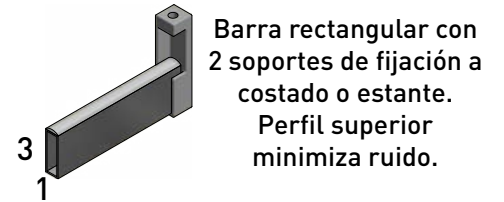
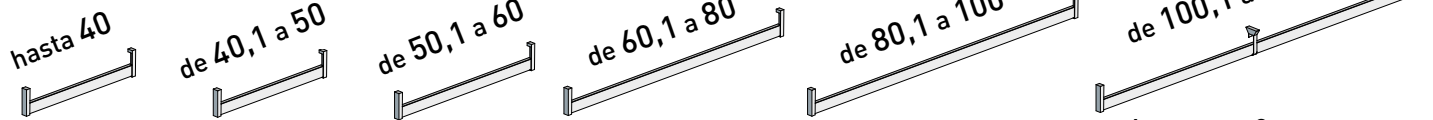
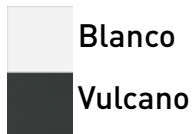

Incorpora 3 soportes.

Ref.	BC4	BC5	BC6	BC8	BC10	BC12
Puntos	16	19	22	25	28	35

ESTANTES CRISTAL FONDO 55,8

Grosor 0.6

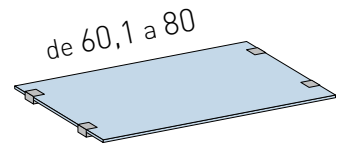
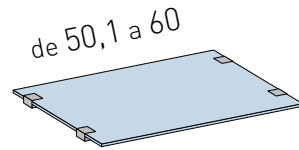
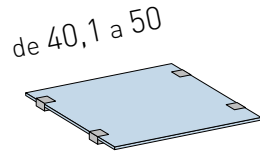
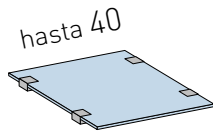

Ref.	EV41	EV51	EV61	EV81
Puntos	54	62	70	87

Grosor 0.6

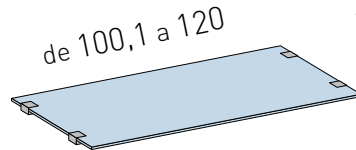
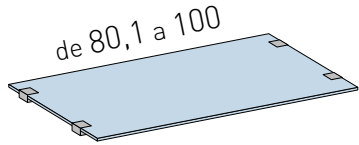

Acabados cristal transparente y opaco

Acabados soporte estante cristal



Ref.	EV101	EV121
Puntos	114	130

BARRA Y ESTANTE CURVO

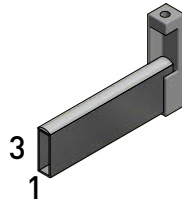

Barra rectangular con 4 soportes de fijación a costado o estante. Perfil superior minimiza el ruido.

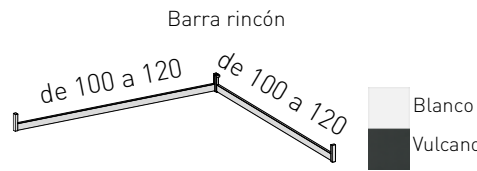
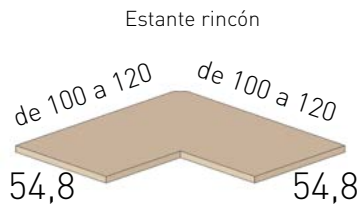

Ref.	ETR8	BN
Puntos	96	50

ZAPATERO FIJO FONDO 55,8

Grosor 3

hasta 40

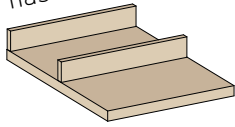

de 40,1 a 50

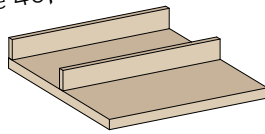

de 50,1 a 60

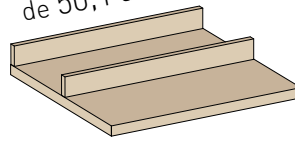

de 60,1 a 80

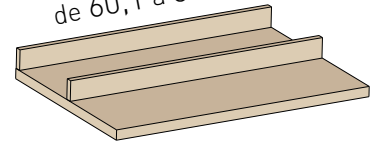

Ref.	EZ41	EZ51	EZ61	EZ81
Puntos	34	38	43	47

Grosor 3

de 80,1 a 100

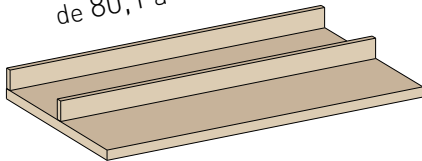

de 100,1 a 120

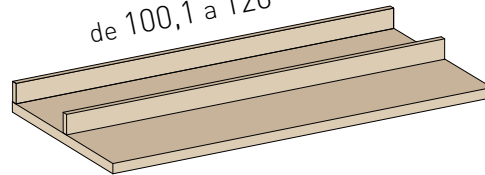

Ref.	EZ101	EZ121
Puntos	50	56

ZAPATERO EXTRAÍBLE FONDO 55,8

Grosor 3

hasta 40

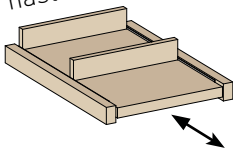

de 40,1 a 50

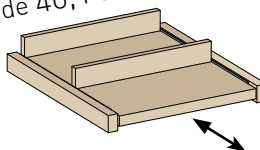

de 50,1 a 60

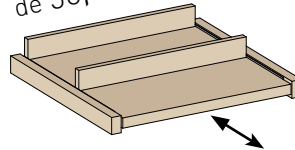

de 60,1 a 80

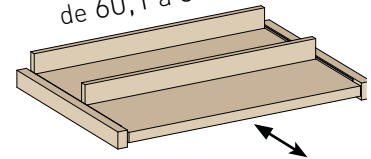

Ref.	EX41	EX51	EX61	EX81
Puntos	59	63	68	72

Grosor 3

de 80,1 a 100

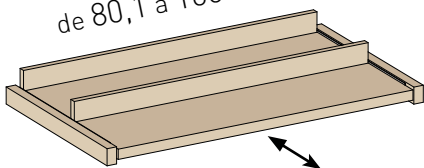

de 100,1 a 120

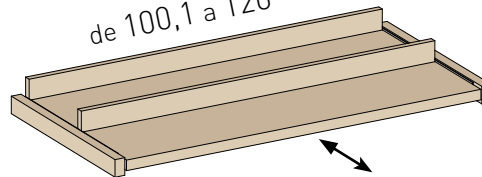

Ref.	EX101	EX121
Puntos	75	81

ZAPATERO INCLINADO FONDO 55,8

* Medidas especiales de fondo consultar con fábrica

Grosor 3

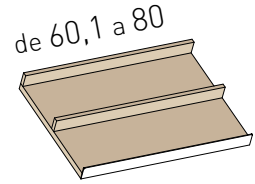
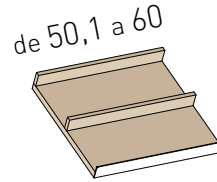
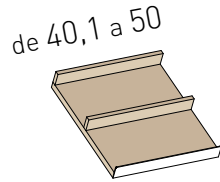

Ref.	EN41	EN51	EN61	EN81
Puntos	40	44	49	53

Grosor 3

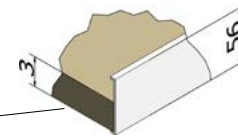
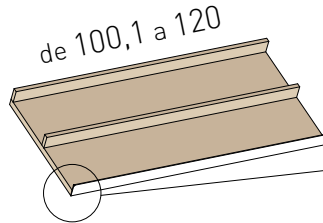
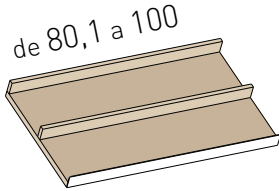

Perfil metálico frontal



Ref.	EN101	EN121
Puntos	56	62

PARTIDORES FONDO 55,8

Grosor 3

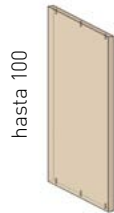

Ref.	DNT10	DNT15	DNT20	DNT30
Puntos	49	54	58	64

COSTILLA 11

Altura 18,5

hasta 40



de 40 a 60



de 60,1 a 80



de 80,1 a 100



de 100,1 a 120



Ref.	CG1114	CG1116	CG1118	CG1110	CG1112
Puntos	76	87	101	112	142

Altura 34

hasta 40



de 40 a 60



de 60,1 a 80



de 80,1 a 100



de 100,1 a 120



Ref.	CG2114	CG2116	CG2118	CG2110	CG2112
Puntos	126	137	158	174	252

Altura 49,5

hasta 40



de 40 a 60



de 60,1 a 80



de 80,1 a 100



de 100,1 a 120



Ref.	CG3114	CG3116	CG3118	CG3110	CG3112
Puntos	176	187	215	236	342

Altura 65

hasta 40



de 40 a 60



de 60,1 a 80



de 80,1 a 100



de 100,1 a 120



Ref.	CG4114	CG4116	CG4118	CG4110	CG4112
Puntos	226	237	265	298	442

Altura 80,5

hasta 40



de 40 a 60



de 60,1 a 80



de 80,1 a 100



de 100,1 a 120



Ref.	CG5114	CG5116	CG5118	CG5110	CG5112
Puntos	276	287	329	360	554

Altura 96

hasta 40



de 40 a 60



de 60,1 a 80



de 80,1 a 100



de 120,1 a 150



Ref.	CG6114	CG6116	CG6118	CG6110	CG6112
Puntos	326	337	386	422	642

COSTILLA 16

Altura 23,5

hasta 40



de 40 a 60



de 60,1 a 80



de 80,1 a 100



de 100,1 a 120

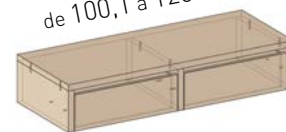

Ref.	CG1164	CG1166	CG1168	CG1160	CG1162
Puntos	81	90	104	115	152

Altura 44

hasta 40



de 40 a 60



de 60,1 a 80



de 80,1 a 100



de 100,1 a 120



Ref.	CG2164	CG2166	CG2168	CG2160	CG2162
Puntos	132	143	164	180	254

Altura 64,5

hasta 40



de 40 a 60



de 60,1 a 80



de 80,1 a 100



de 100,1 a 120



Ref.	CG3164	CG3166	CG3168	CG3160	CG3162
Puntos	186	196	224	245	362

Altura 85

hasta 40



de 40 a 60



de 60,1 a 80



de 80,1 a 100



de 100,1 a 120



Ref.	CG4164	CG4166	CG4168	CG4160	CG4162
Puntos	239	249	284	310	468

Altura 105,5

hasta 40



de 40 a 60



de 60,1 a 80



de 80,1 a 100



de 100,1 a 120



Ref.	CG5164	CG5166	CG5168	CG5160	CG5162
Puntos	292	302	344	375	574

CAJONERAS PARA COLGAR FONDO 47,5

COSTILLA 11				COSTILLA 16			
Altura 18,5	hasta 60	de 60,1 a 80	de 80,1 a 100	hasta 60	de 60,1 a 80	de 80,1 a 100	
	Ref. CG116C	Ref. CG118C	Ref. CG110C	Ref. CG126C	Ref. CG128C	Ref. CG120C	
Puntos 87	Puntos 101	Puntos 112	Puntos 90	Puntos 104	Puntos 115		
Altura 34	hasta 60	de 60,1 a 80	de 80,1 a 100	hasta 60	de 60,1 a 80	de 80,1 a 100	
	Ref. CG216C	Ref. CG218C	Ref. CG210C	Ref. CG226C	Ref. CG228C	Ref. CG220C	
Puntos 137	Puntos 158	Puntos 174	Puntos 143	Puntos 164	Puntos 180		

CAJONES SEPARADORES

Incremento por separadores (Cajón no incluido)

Altura 18,5	hasta 60	de 60,1 a 80	de 80,1 a 100	de 100,1 a 120
	Ref. CRB603	Ref. CRB683	Ref. CRB103	Ref. CRB123
Puntos 24	Puntos 30	Puntos 34	Puntos 42	

CASILLERO FONDO 47,5

Altura 36	de 60,1 a 80	de 80,1 a 100	de 100,1 a 120
	Ref. CS80	Ref. CS10	Ref. CS12
Puntos 90	Puntos 114	Puntos 148	

PANTALONEROS FONDO 47,5

Altura 18,5	hasta 60	de 60,1 a 80	de 80,1 a 100
	Ref. PNT601	Ref. PNT681	Ref. PNT101
Puntos 144	Puntos 156	Puntos 172	

OPCIONES

Zapatero extensible y extraíble

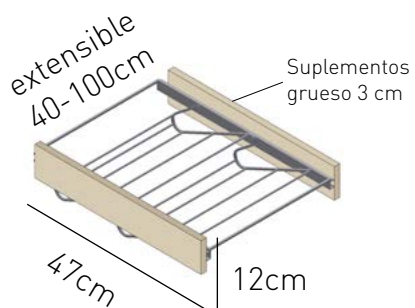

Barra abatible y extensible



Mesa planchar plegable

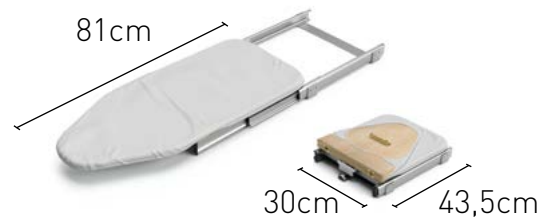

Precisa de un estante de soporte.

Ref.	ZPR	BRT	TPL
Puntos	100	110	168

LEDS

*Sensor movimiento incorporado

1 tira de led



2 tiras de leds



Ref.	LED10	LED20
Puntos	168	288

LUNAS INTERIORES

200



220



*Imprescindible indicar posición

*Estantes interiores -1cm

Ancho	Ref.	Puntos
28	LUN34	140
38	LUN44	160
48	LUN54	180

Ancho	Ref.	Puntos
28	LUN36	150
38	LUN46	170
48	LUN56	190

Disponibles cajones de 11, 16 y 22 cm de alto en costilla.

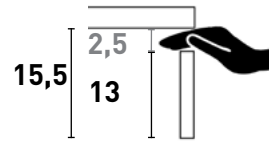

Ancho total de 40 a 60		Ancho total de 60,1 a 80		Ancho total de 80,1 a 100	
Altura Costilla	Altura Total	Altura Costilla	Altura Total	Altura Costilla	Altura Total
11	15,5	11	15,5	11	15,5
16	20,5	16	20,5	16	20,5
22	29,5	22	29,5	22	29,5

Ref.	Puntos	Ref.	Puntos	Ref.	Puntos
CGN116	50	CGN118	57	CGN110	62
CGN166	53	CGN168	60	CGN160	65
CGN156	65	CGN158	72	CGN150	77



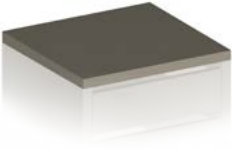
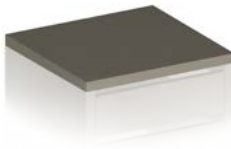
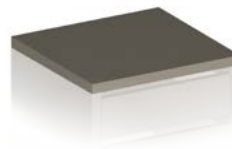

En el precio de los lados de la cajonera va incluido en cada cajón.

Ancho total de 40 a 60	Ancho total de 60,1 a 80	Ancho total de 80,1 a 100
		
Tapa	Tapa	Tapa

Ref.	Puntos	Ref.	Puntos	Ref.	Puntos
CFN146	37	CFN168	44	CFN180	50

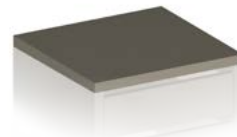
Seleccionar altura y cantidad de cajones + una tapa (obligatoria), todos del mismo ancho.
Con estas referencias ya podemos crear la cajonera de libre composición.

Ejemplo de cajonera de 40 a 60:

11		CGN116	50	+  CFN146 37 = 	Altura frente + espacio entre cajones 3 Altura Tapa 15,5 Altura Costilla 11 20,5 Altura Costilla 16 20,5 Altura Costilla 16 29,5 Altura Costilla 22
16		CGN166	53		
16		CGN166	53		
22		CGN156	65		
Puntos Total (50 + 53 + 53 + 65) + 37 258				Altura Total (3 + 15,5 + 20,5 + 20,5 + 29,5) 89	

CAJONES EXTERIORES LIBRE CONFIGURACIÓN

Ancho total de 40 a 60		Ancho total de 60,1 a 80		Ancho total de 80,1 a 100	
Altura Costilla	Altura Total	Altura Costilla	Altura Total	Altura Costilla	Altura Total
11	18	11	18	11	18
Ref. CGE16	Puntos 50	Ref. CGE18	Puntos 57	Ref. CGE10	Puntos 62
16	24	16	24	16	18
Ref. CGE66	Puntos 53	Ref. CGE68	Puntos 60	Ref. CGE60	Puntos 65
22	30	22	30		
Ref. CGE56	Puntos 65	Ref. CGE58	Puntos 72		

En precio del cajón esta incluido el tirador standard.

Ancho total de 40 a 60	Ancho total de 60,1 a 80	Ancho total de 80,1 a 100
Ref.	Ref.	Ref.
CFE46	CFE68	CFE80
Puntos 37	Puntos 44	Puntos 50
Estante	Estante	Estante

Seleccionar altura y cantidad de cajones + un estante (obligatorio), todos del mismo ancho.
Con estas referencias ya podemos crear la cajonera de libre composición.

Ejemplo:

11		CGE16	50	+ =	18 Altura Costilla 11 24 Altura Costilla 16 24 Altura Costilla 16 30 Altura Costilla 22
16		CGE66	53		
16		CGE66	53		
22		CGE56	65		
		CFE46	37		
Puntos Total (50 + 53 + 53 + 65) + 37 258					

ESTRUCTURA

Cajón frente cristal

Costillas laterales acabado único ANTRACITA

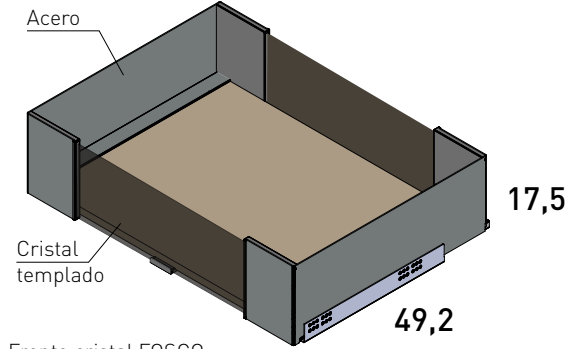

Acabados laminados base cajón

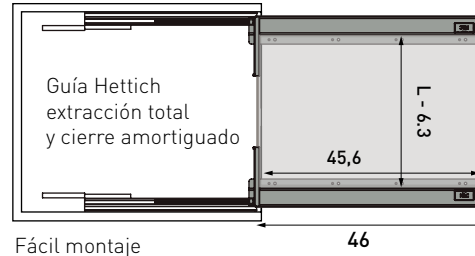
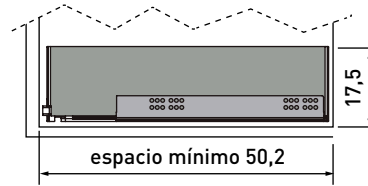

Fácil montaje
Espaciador para salvar bisagras incorporado

L hueco armario	Ref.	Puntos
40-50	CF140	171
50-60	CF150	177
60-70	CF160	180
70-80	CF170	191
80-90	CF180	198
90-100	CF190	204
100-110	CF100	211
110-116	CF110	218

Cajón frente cristal

Costillas laterales acabado único ANTRACITA

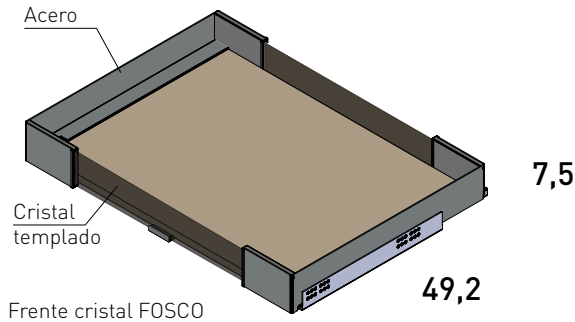

Acabados laminados base cajón

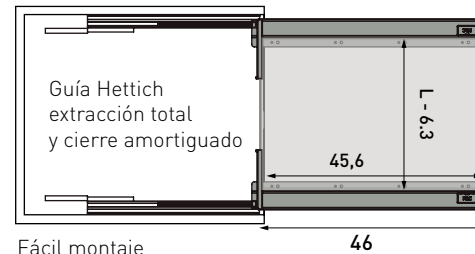
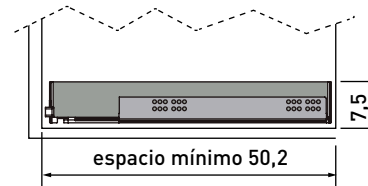

Fácil montaje
Espaciador para salvar bisagras incorporado

L hueco armario	Ref.	Puntos
40-50	CF740	158
50-60	CF750	162
60-70	CF760	166
70-80	CF770	173
80-90	CF780	179
90-100	CF790	186
100-110	CF700	193
110-116	CF711	201

COMPLEMENTOS

Joyero organizador

Acabado TITANIO

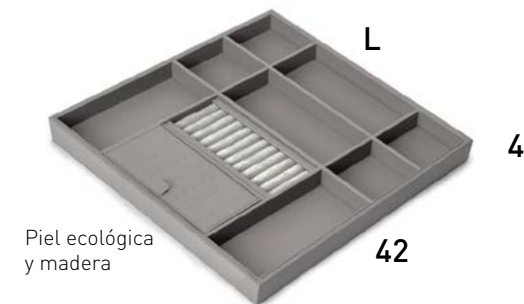

Piel ecológica y madera

L	Ref.	Puntos
44	JR4	88
54	JR5	100
64	JR6	112
74	JR7	124

Caja accesorios

Acabado único ANTRACITA
Acero

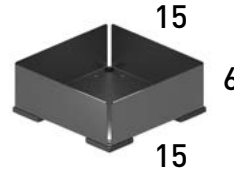

L	Ref.	Puntos
15	CAJ15	24

Bandeja accesorios

Acabado único ANTRACITA
Acero



L	Ref.	Puntos
28	BAN28	28
45	BAN45	30

ESTRUCTURA

Cajón zapatero frente cristal

Costillas laterales acabado único ANTRACITA

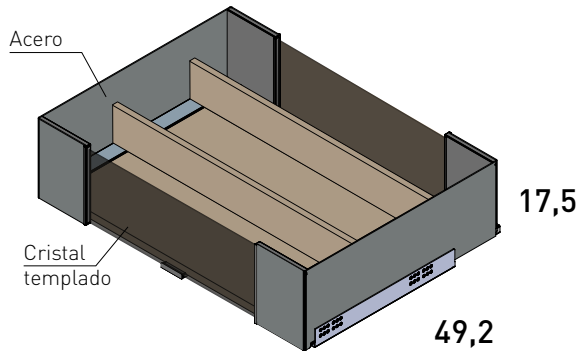

Frente cristal FOSCO

Acabados laminados base cajón

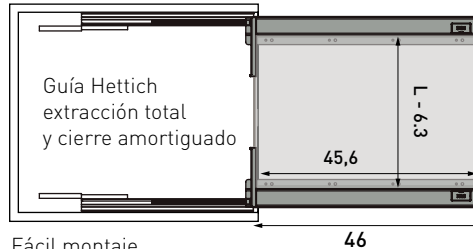
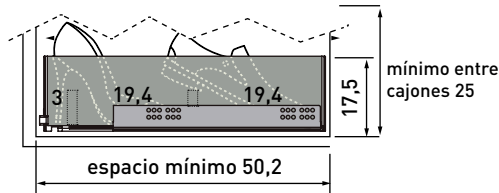

Fácil montaje
Espaciador para salvar bisagras incorporado

L hueco armario	Ref.	Puntos
40-50	CZ40	184
50-60	CZ50	191
60-70	CZ60	199
70-80	CZ70	210
80-90	CZ80	219
90-100	CZ90	226
100-110	CZ10	235
110-116	CZ11	242

COLGADORES

Perchero Abatible

Acabado único ANTRACITA
Acero

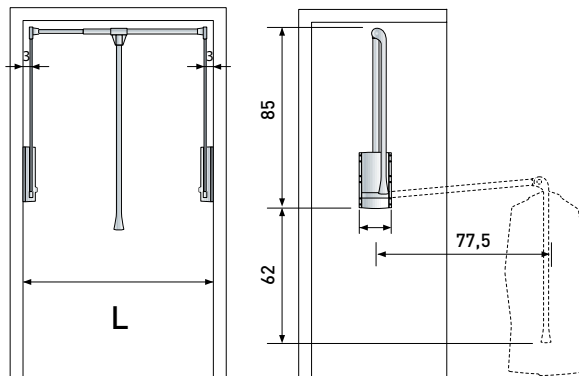
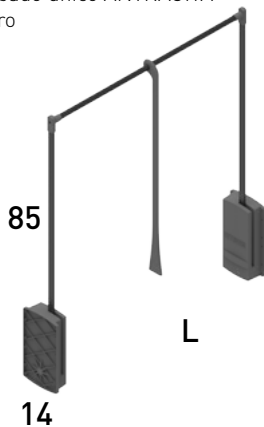

L hueco armario	Ref.	Puntos
44-60	PER4	114
60-90	PER6	130
90-116	PER7	134

Perchero extraíble SUPERIOR

Acabado único ANTRACITA
Acero

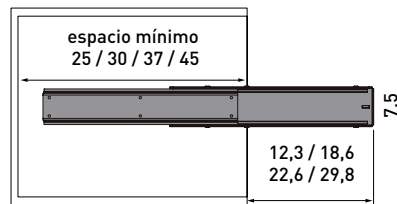
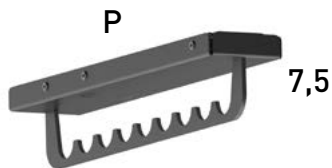

Carga máxima 15kg
Necesita estante superior

P	Ref.	Puntos
24	PEX24	44
29	PEX29	46
36	PEX36	48
44	PEX44	50

Barras colgar

Acabado ANTRACITA
Aluminio

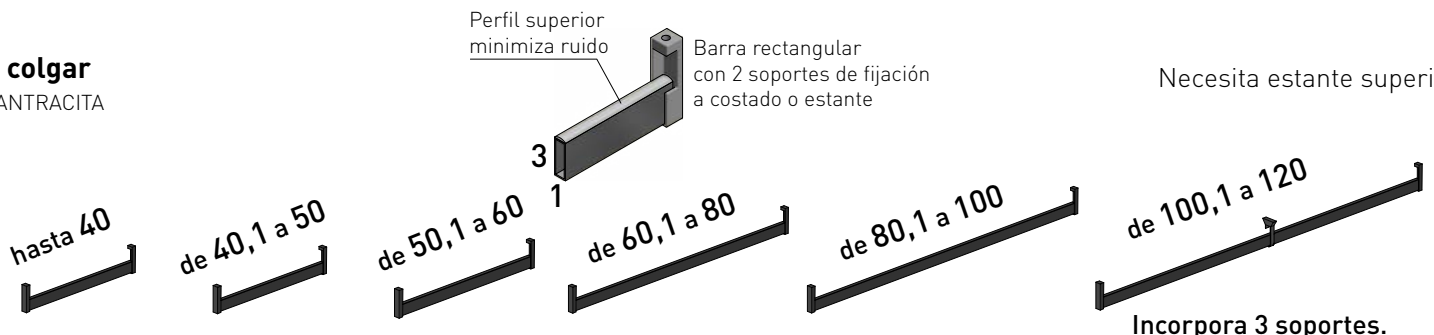

Ref.	BL40	BL50	BL60	BL80	BL10	BL12
Puntos	18	21	25	27	30	38

ACCESORIOS

Zapatero lateral extraíble

Acabado único ANTRACITA
Acero

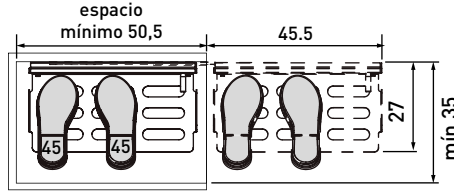
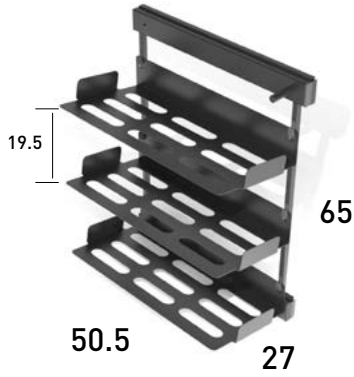

Espaciador para salvar bisagras incorporado

L	Ref.	Puntos
DR	Z65D	196
IZ	Z65Z	196

Cesta de tela

Estructura ANTRACITA
Acero / Tela gris



Espaciador para salvar bisagras incorporado

L	Ref.	Puntos
53,5-58,5	CET5	226
58,5-63,5	CET6	234

Corbatero lateral extraíble

Acabado único ANTRACITA
Acero

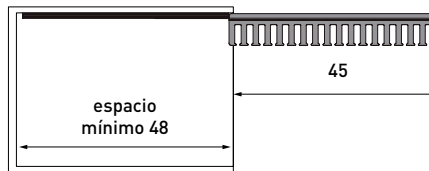
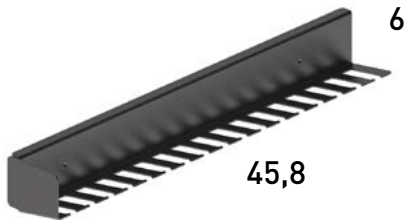

Espaciador para salvar bisagras incorporado

L	Ref.	Puntos
DR	CORD	65
IZ	CORZ	65

Espejo lateral extraíble

Acabado único GRAFITO

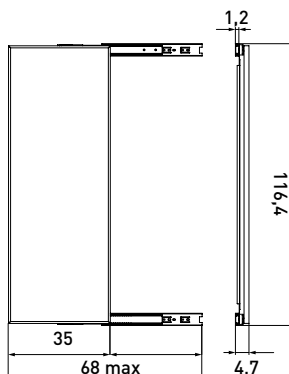
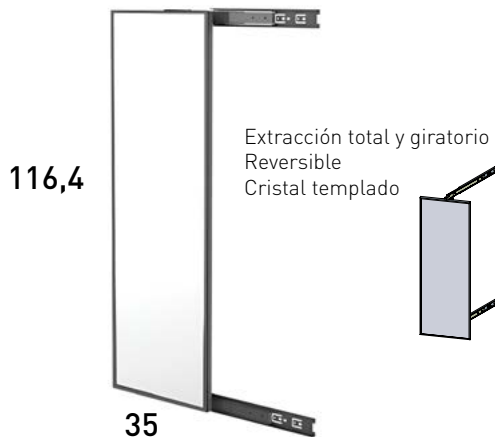

Espaciador para salvar bisagras incorporado

L	Ref.	Puntos
35	ESPEX	90

Guía Hettich extracción total y cierre amortiguado
Soportes con funda antideslizante

PANTALONEROS

Bandeja pantalonero

Acabado único ANTRACITA
Acero

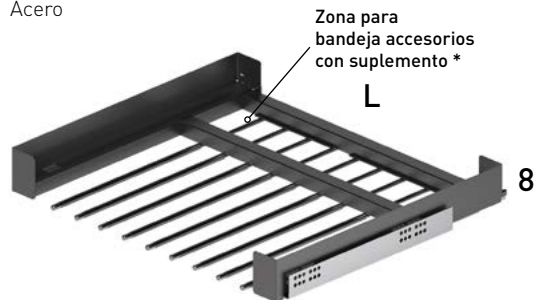

Carga máxima 30kg

49

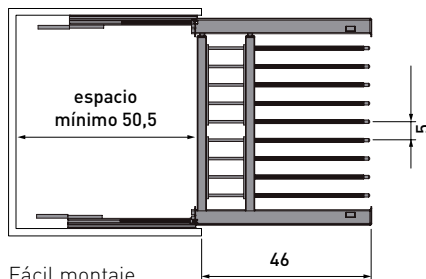

Fácil montaje
Espaciador para salvar bisagras incorporado

Soportes	L	Ref.	Puntos
7-9	50,5-60,5	PAX60	204
9-11	60,5-70,5	PAX70	209
11-13	70,5-80,5	PAX80	219
13-15	80,5-90,5	PAX90	227

Bandeja accesorios

Acabado único ANTRACITA



* Bandejas recomendadas según medida
de 50,5 a 65,5 cm 1 unidad
de 65,5 a 85,5 cm 2 unidades
de 85,5 a 90,5 cm 3 unidades

Ref.	Puntos
BDA24	14

Pantalonero extraíble LATERAL

Acabado único ANTRACITA
Acero

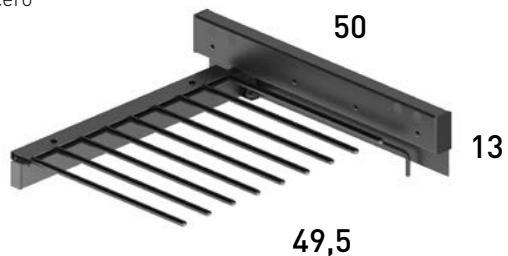

Reversible
Para 9 pantalones

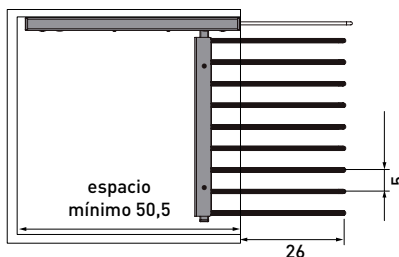

Espaciador para salvar bisagras incorporado

Ref.	Puntos
PAXL	133

Pantalonero extraíble SUPERIOR

Acabado único ANTRACITA
Acero

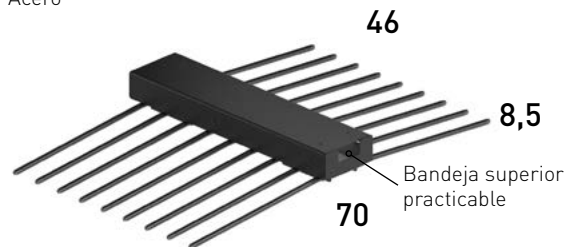

Para 18 pantalones.
Necesita estante superior

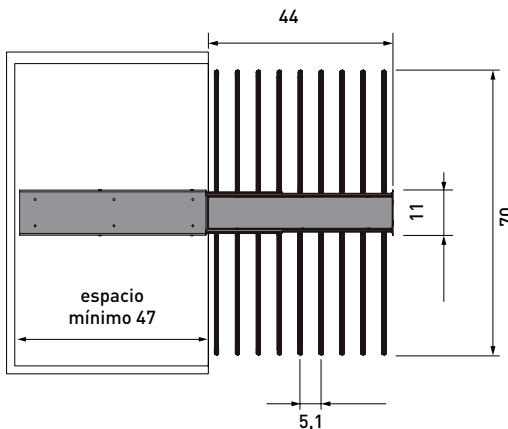

Ref.	Puntos
PAX18	148

Pantalonero extraíble SUPERIOR

Acabado único ANTRACITA
Acero

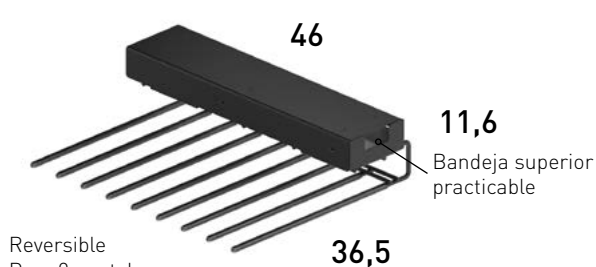

Reversible
Para 9 pantalones
Necesita estante superior

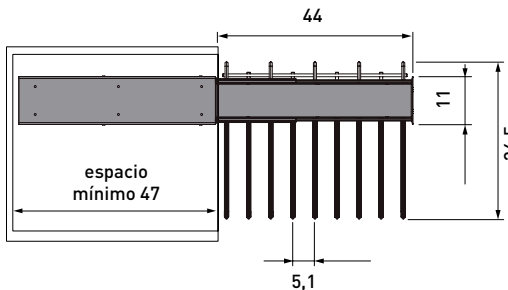

Ref.	Puntos
PAX9	112



Estructuras para interiores de armario
(Interiores no regulables en altura)



Columnas aluminio

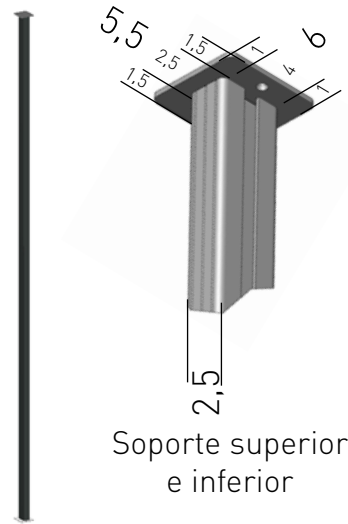

Altura	Ref.	Puntos
150 - 200	CAL1	86
201 - 274	CAL2	96

- Blanco
- Vulcano

Estos estantes no tienen mano.



Grueso 3



1 soporte incluido + 2 soportes UX

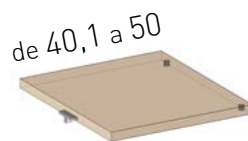

1 soporte incluido + 2 soportes UX

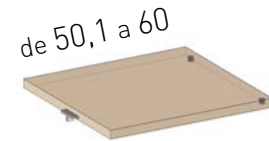

1 soporte incluido + 2 soportes UX

Ref.	ET74	ET75	ET76
Puntos	37	40	44

Grueso 3

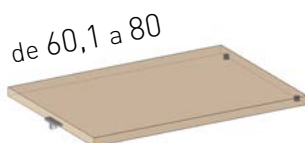

1 soporte incluido + 2 soportes UX

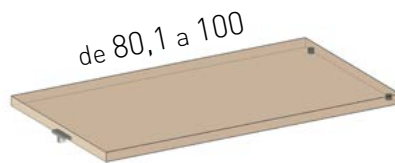

1 soporte incluido + 2 soportes UX

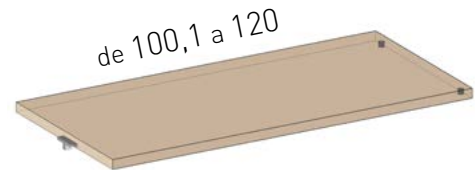

1 soporte incluido + 2 soportes UX

Ref.	ET78	ET70	ET72
Puntos	47	49	54



ESTANTES EXTRAIBLE FONDO 55,8

Grosor 3

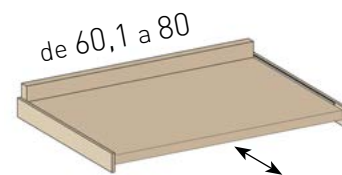
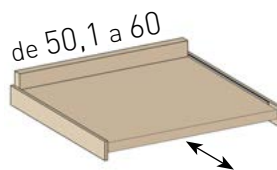
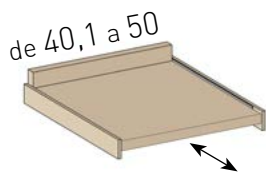
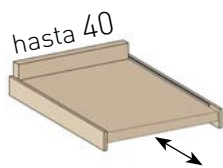

No tiene mano
Soportes incluidos

Ref.	ETX42	ETX52	ETX62	ETX82
Puntos	69	72	76	79

ESTANTES CRISTAL FONDO 55'8

Grosor 0.6

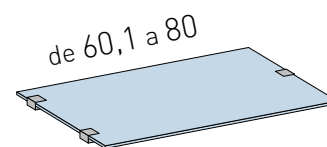
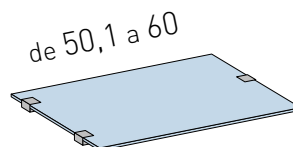
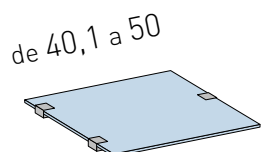
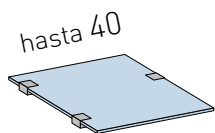

No tiene mano
Soportes incluidos

Ref.	EV42	EV52	EV62	EV82
Puntos	66	74	82	99

Grosor 0.6

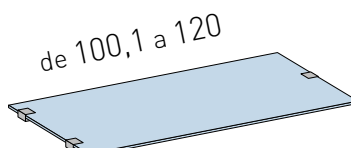
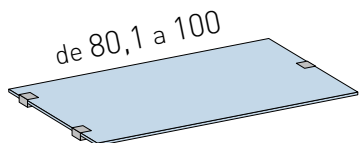

Acabados cristal
transparente y opaco

Acabados soporte
estante cristal



Ref.	EV102	EV122
Puntos	126	142

ZAPATERO FIJO FONDO 55'8

Grosor 3

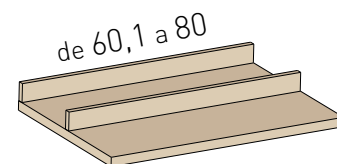
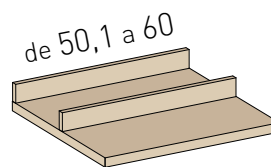
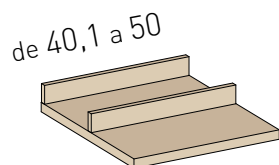
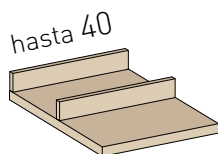

Soportes incluidos

	izquierda	derecha	izquierda	derecha	izquierda	derecha	izquierda	derecha
Ref.	EZ42Z	EZ42D	EZ52Z	EZ52D	EZ62Z	EZ62D	EZ82Z	EZ82D
Puntos	49	49	53	53	57	57	62	62

Grosor 3

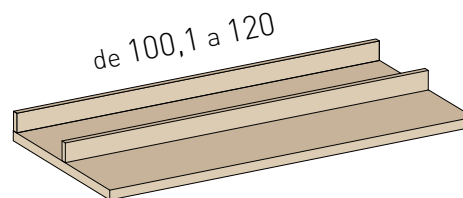
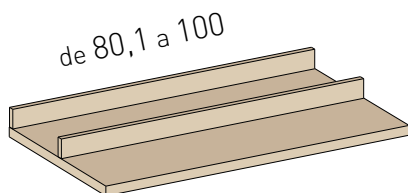

	izquierda	derecha	izquierda	derecha
Ref.	EZ102Z	EZ102D	EZ122Z	EZ122D
Puntos	65	65	71	71



ZAPATERO EXTRAÍBLE FONDO 55'8

No tiene mano
Soportes incluidos

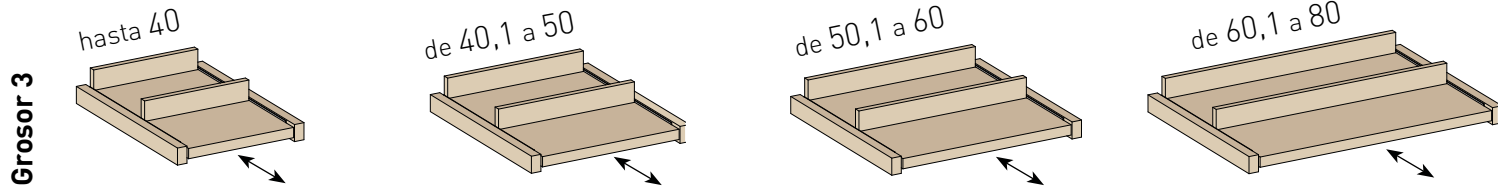

Ref.	EX42	EX52	EX62	EX82
Puntos	71	75	80	84

BARRAS

No tiene mano
Soportes incluidos



Cada barra incorpora un juego de dos soportes.

Ref.	BC45	BC56	BC68	BC100
Puntos	27	30	33	41

CAJONERAS FONDO 47,5

Para cajón separador pag 58.

Costilla de 11

No tiene mano
Soportes incluidos

Altura 21,5



Ref.	CG161	CG181	CG101
Puntos	111	125	136

Altura 37



Ref.	CG261	CG281	CG201
Puntos	161	182	198

PANTALONEROS FONDO 47,5

No tiene mano
Soportes incluidos

Altura 18,5

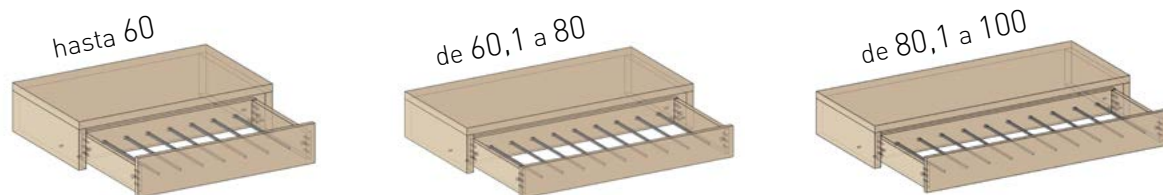

Ref.	PNT603	PNT683	PNT103
Puntos	162	174	190

OPCIONES RAIL SYSTEM

EJEMPLO 3 ELEGIR INTERIORES

Añade una referencia de sistema de guías por cada hueco que desees equipar con el Rail System

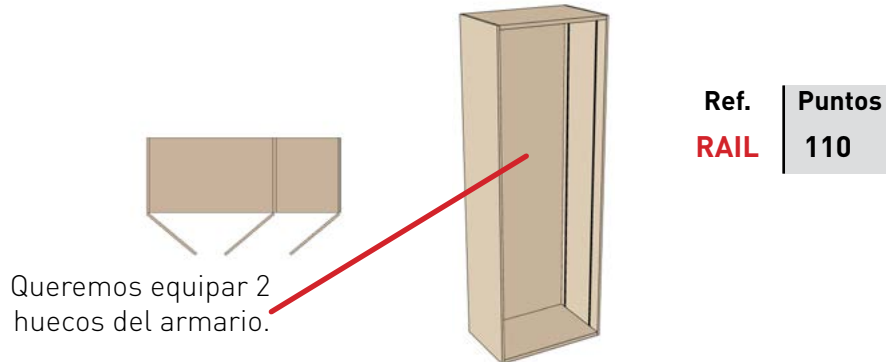

Deseamos añadir 2 estantes, una barra de colgar y una cajonera al interior de un armario de 95 cm, de 239 cm de altura.

Buscar las opciones de interior deseadas para un hueco interior de 91,2.

Al modificar el armario de 100 a 95 las medidas de hueco son 91,2.

Ref.	Puntos
ET60R	48
ET60R	48
BC10R	30
CG2110R	229

Las opciones de interior se adaptan a la medida exacta del hueco interior.

No hay incremento en los puntos por recortar las opciones, son un total de **465 puntos**.

OPCIONES PARA ARMARIOS BATIENTES CON RAIL SYSTEM

RAIL SYSTEM



* Incluir una referencia por cuerpo

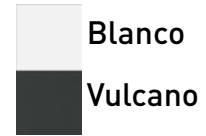

Ref.	RAIL
Puntos	110

ESTANTES FONDO 55,8

Grosor 3

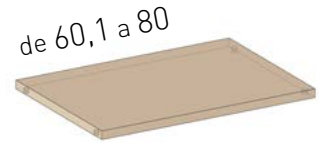
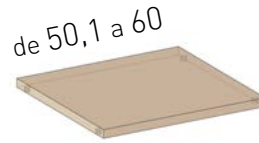
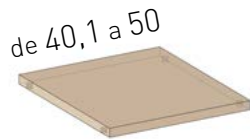
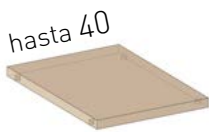

Ref.	ET64R	ET65R	ET66R	ET68R
Puntos	36	39	43	46

Grosor 3

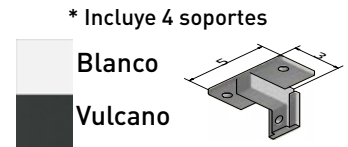
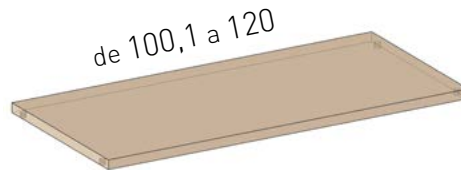
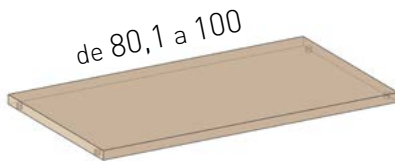

Ref.	ET60R	ET62R
Puntos	48	53

ESTANTES EXTRAIBLES FONDO 55,8

Grosor 3

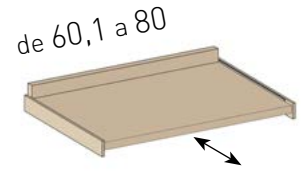
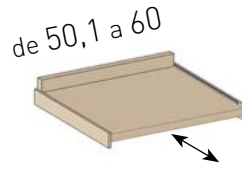
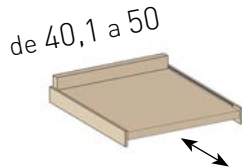

Ref.	ETT64R	ETT65R	ETT66R	ETT68R
Puntos	68	71	75	79

Grosor 3

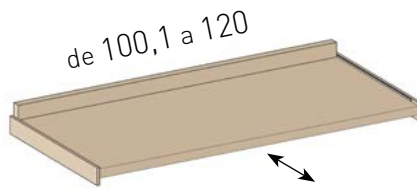
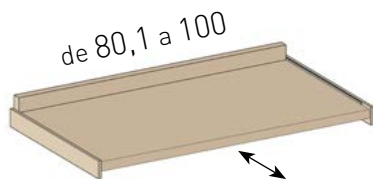

Ref.	ETT60R	ETT62R
Puntos	80	85

BARRAS

*** Obligatorio un estante superior**

Blanco
Vulcano

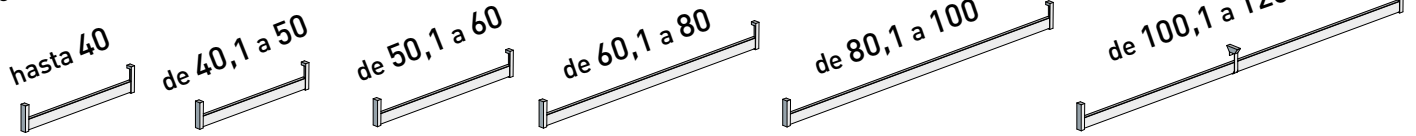

Barra rectangular con 2 soportes de fijación a estante. Perfil superior minimiza ruido.

Incorpora 3 soportes.

Ref.	BC4R	BC5R	BC6R	BC8R	BC10R	BC12R
Puntos	18	21	24	27	30	37

ESTANTES CRISTAL FONDO 55,8

Grosor 0,6

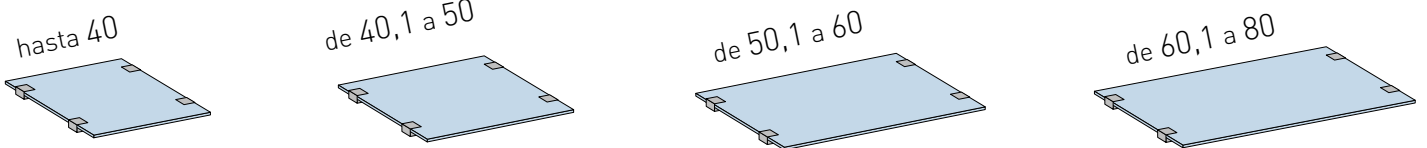

Ref.	EV41R	EV51R	EV61R	EV81R
Puntos	76	84	92	108

Grosor 0,6

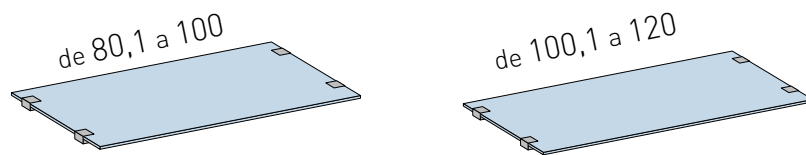

Acabados cristal transparente y opaco

Acabados soporte estante cristal

Ref.	EV101R	EV121R
Puntos	126	152

BARRA Y ESTANTE CURVO

*** Incluye 5 soportes**

Blanco
Vulcano

Estante rincon

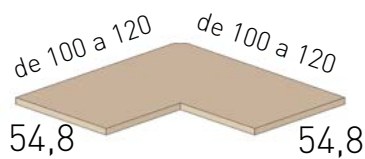

*** Obligatorio un estante superior**

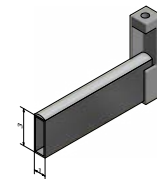

Barra rincón

Barra rectangular con 2 soportes de fijación a estante. Perfil superior minimiza ruido.

Blanco
Vulcano

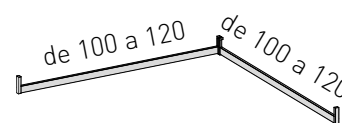

Ref.	ETR8R	BNR
Puntos	116	53

OPCIONES PARA ARMARIOS BATIENTES CON RAIL SYSTEM

ZAPATERO FIJO FONDO 55,8

Grosor 3	hasta 40	de 40,1 a 50	de 50,1 a 60	de 60,1 a 80
Ref.	EZ41R	EZ51R	EZ61R	EZ81R
Puntos	48	52	57	61

Grosor 3	de 80,1 a 100	de 100,1 a 120	<p>* Incluye 4 soportes</p> <p>Blanco </p> <p>Vulcano </p>
Ref.	EZ101R	EZ121R	
Puntos	64	70	

ZAPATERO EXTRAÍBLE FONDO 55,8

Grosor 3	hasta 40	de 40,1 a 50	de 50,1 a 60	de 60,1 a 80
Ref.	EX41R	EX51R	EX61R	EX81R
Puntos	73	77	82	86

Grosor 3	de 80,1 a 100	de 100,1 a 120	<p>* Incluye 4 soportes</p> <p>Blanco </p> <p>Vulcano </p>
Ref.	EX101R	EX121R	
Puntos	89	95	

LUNAS INTERIORES

200		Ancho	Ref.	Puntos
		28	LUN34	140
		38	LUN44	160
		48	LUN54	180

220		Ancho	Ref.	Puntos
		28	LUN36	150
		38	LUN46	170
		48	LUN56	190

OPCIONES PARA ARMARIOS BATIENTES CON RAIL SYSTEM

PARTIDORES FONDO 55'8

Grosor 3

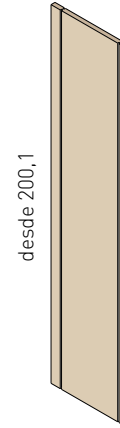
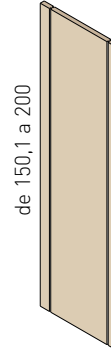
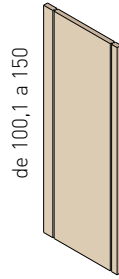
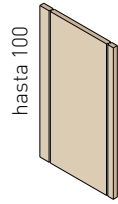

*Por defecto incluye Rail System por ambos lados.

Ref.	DNT10R	DNT15R	DNT20R	DNT30R
Puntos	94	124	163	174

PARTIDORES ALUMINIO

Blanco
Vulcano

* Compatible solo con cajoneras colgadas

Grosor 3

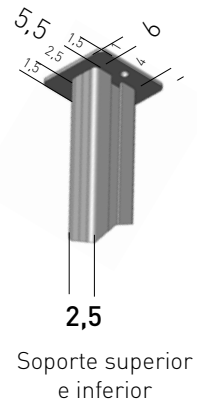
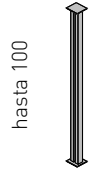

Ref.	CAL10	CAL15	CAL20	CAL30
Puntos	46	52	86	96

OPCIONES

Zapatero extensible y extraíble

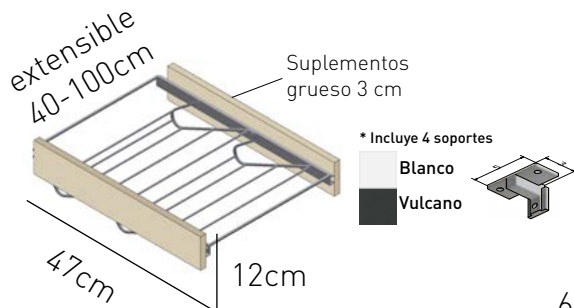

Barra abatible y extensible

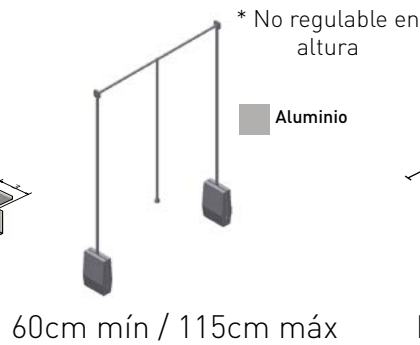

Mesa planchar plegable



Ref.	ZPR3	BRT	TPL
Puntos	105	110	168

LEDS

*Sensor movimiento incorporado

1 tira de led



2 tiras de leds



Ref.	LED10	LED20
Puntos	168	288

COSTILLA 11

* Incluye 4 soportes

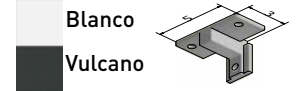

Altura 21,5

hasta 40



de 40,1 a 60



de 60,1 a 80



de 80,1 a 100



de 100,1 a 120



Ref.	CG1114R	CG1116R	CG1118R	CG1110R	CG1112R
Puntos	110	126	146	163	223

Altura 37

hasta 40



de 40,1 a 60



de 60,1 a 80



de 80,1 a 100



de 100,1 a 120



Ref.	CG2114R	CG2116R	CG2118R	CG2110R	CG2112R
Puntos	160	178	206	229	327

Altura 52,5

hasta 40



de 40,1 a 60



de 60,1 a 80



de 80,1 a 100



Ref.	CG3114R	CG3116R	CG3118R	CG3110R
Puntos	210	230	266	295

Altura 68

hasta 40



de 40,1 a 60



de 60,1 a 80



de 80,1 a 100



Ref.	CG4114R	CG4116R	CG4118R	CG4110R
Puntos	260	282	326	361

Altura 18,5

hasta 60



de 60,1 a 80



de 80,1 a 100



* Incluye 4 soportes

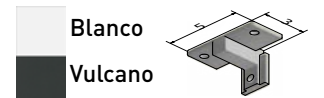

Ref.	PNT601R	PNT681R	PNT101R
Puntos	168	180	196

CAJONERAS FONDO 47,5

COSTILLA 16

* Incluye 4 soportes



Altura 26,5

hasta 40



de 40,1 a 60



de 60,1 a 80



de 80,1 a 100



de 100,1 a 120



Ref.	CG1164R	CG1166R	CG1168R	CG1160R	CG1162R
Puntos	115	130	150	167	231

Altura 47

hasta 40



de 40,1 a 60



de 60,1 a 80



de 80,1 a 100



de 100,1 a 120



Ref.	CG2164R	CG2166R	CG2168R	CG2160R	CG2162R
Puntos	165	186	214	237	343

Altura 67,5

hasta 40



de 40,1 a 60



de 60,1 a 80



de 80,1 a 100



Ref.	CG3164R	CG3166R	CG3168R	CG3160R
Puntos	220	242	278	307

SEPARADORES CAJONES

Incremento por separadores (Cajón no incluido)

Altura 18,5

hasta 60



de 60,1 a 80



de 80,1 a 100

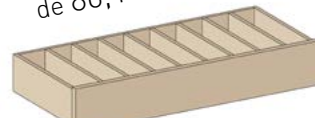

de 100,1 a 120



Ref.	CRB603	CRB683	CRB103	CRB123
Puntos	24	30	34	42

CASILLERO FONDO 47,5

* Incluye 4 soportes

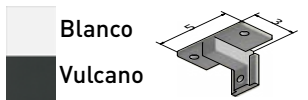

Altura 36

de 60,1 a 80

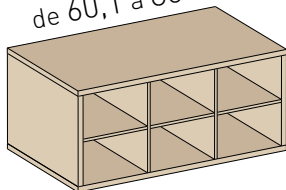

de 80,1 a 100

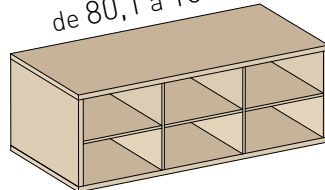

de 100,1 a 120

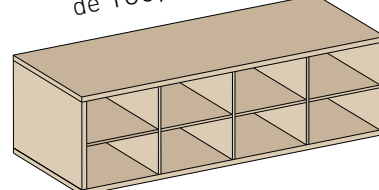

Ref.	CS80R	CS10R	CS12R
Puntos	114	138	172

Disponibles cajones de 11 y 16 de alto en costilla.

Altura Costilla	Ancho total de 40 a 60	Altura Total	Ref.	Puntos	Altura Costilla	Ancho total de 60,1 a 80	Altura Total	Ref.	Puntos	Altura Costilla	Ancho total de 80,1 a 100	Altura Total	Ref.	Puntos
11	15,5	CGN116R	50	11	15,5	CGN118R	57	11	15,5	CGN110R	62			
16	20,5	CGN166R	53	16	20,5	CGN168R	60	16	20,5	CGN160R	65			

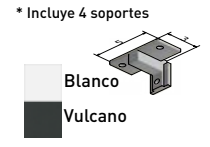
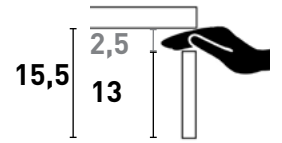

Ancho total de 40 a 60	Ref.	Puntos	Ancho total de 60,1 a 80	Ref.	Puntos	Ancho total de 80,1 a 100	Ref.	Puntos
Tapa y base	CFN146R	75	Tapa y base	CFN168R	87	Tapa y base	CFN180R	97

Seleccionar altura y cantidad de cajones + una tapa (obligatoria), todos del mismo ancho. Con estas referencias ya podemos crear la cajonera de libre composición.

Ejemplo de cajonera de 40 a 60:

11		CGN116R	52	+	=		3	Altura Tapa	
16		CGN166R	56				15,5	Altura Costilla 11	
16		CGN166R	56				20,5	Altura Costilla 16	
16		CGN166R	56				20,5	Altura Costilla 16	
							3	Altura Tapa	
Puntos Total									
(52 + 56 + 56) + 75									
239									
Altura Total									
(3 + 15,5 + 20,5 + 20,5 + 3)									
62,5									

CAJONES EXTERIORES LIBRE CONFIGURACIÓN

Ancho total de 40 a 60		Ancho total de 60,1 a 80		Ancho total de 80,1 a 100	
Altura Costilla	Altura Total	Altura Costilla	Altura Total	Altura Costilla	Altura Total
11	18	11	18	11	18
Ref. CGE16R	Puntos 50	Ref. CGE18R	Puntos 57	Ref. CGE10R	Puntos 62
16	24	16	24	16	24
Ref. CGE66R	Puntos 53	Ref. CGE68R	Puntos 60	Ref. CGE60R	Puntos 65
22	30	22	30		
Ref. CGE56R	Puntos 65	Ref. CGE58R	Puntos 72		

En el precio del cajón esta incluido el tirador standard.

Ancho total de 40 a 60	Ancho total de 60,1 a 80	Ancho total de 80,1 a 100
Ref. CFE46R	Ref. CFE68R	Ref. CFE80R
Puntos 37	Puntos 44	Puntos 50
Estante	Estante	Estante

Seleccionar altura y cantidad de cajones + un estante (obligatorio), todos del mismo ancho.
Con estas referencias ya podemos crear la cajonera de libre composición.

Ejemplo:

11		CGE16R	50	+		=		CFE46R CGE16R 18 Altura Costilla 11 CGE66R 24 Altura Costilla 16 CGE66R 24 Altura Costilla 16 CGE56R 30 Altura Costilla 22
16		CGE66R	53					
16		CGE66R	53					
22		CGE56R	65					
								Puntos Total (50 + 53 + 53 + 65) + 37 258

OPCIONES PARA ARMARIOS

TAPETAS

Grosor 1,9

Medidas máximas 282 x 20 cm

Acabado BASE	TAP	Acabado STONE	TAS
	15		17

Acabado BASE	TAP	Acabado STONE	TAS
	15		17

19 L H

Especificar los cantos a chapar. Largos o cortos.

	Acabado BASE		Acabado STONE	
	Ref.	Pts ML	Ref.	Pts ML
sin chapar	8TA	8	8TS	10
1 canto chapado	8TA1	11	8TS1	13
2 cantos chapados	8TA2	14	8TS2	16
3 cantos chapados	8TA3	17	8TS3	19
4 cantos chapados	8TA4	20	8TS4	23

Precio metro lineal

Precio mínimo 1 metro lineal.

FORROS 19

Grosor 1,9

Acabado BASE	FR401	Acabado STONE	FS401
	54		60

Acabado BASE	FR601	Acabado STONE	FS601
	60		66

Acabado BASE	FR801	Acabado STONE	FS801
	66		72

FORROS 10

Grosor 1

Acabado BASE	FR411	Acabado STONE	FS411
	41		45

Acabado BASE	FR611	Acabado STONE	FS611
	47		52

Acabado BASE	FR811	Acabado STONE	FS811
	53		58

Por cada color cliente que se aplique hay un mínimo 176 puntos.
En el caso de no llegar al mínimo en el conjunto de piezas del mismo color, se aplicará esta cantidad.

INCREMENTO POR COLOR MUESTRA

Puertas

Forros

Perfilería

Frente cajón

Tirador

Tapeta



2 caras

Precio metro lineal.

Ref.	altura	LAC1	altura	LAC2	altura	LAC3	LAC4	LAC5	LAC7
Puntos	120	64	120	42	120	32	15	10	12
	280	88	280	60	280	50	puntos/ud	puntos/ud	puntos/ml

CARACTERÍSTICAS TÉCNICAS ARMARIOS PUERTAS PLEGABLES

**Distribución interior según diseño cliente.
Mantiene integridad superficie con taladros solo donde sean necesarios.**

**Nuevo sistema de guía superior e inferior
mejora la suavidad de la apertura.**



**Sistema de fijación de estantes con bloqueo
mejora seguridad y capacidad de carga**

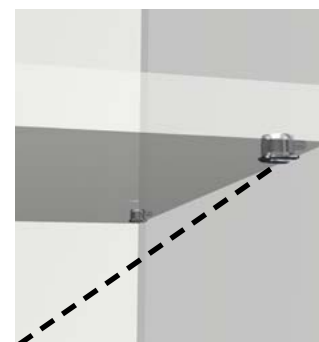

**Costados y divisiones
canteados en los 4
costados**

**Trasera de 10mm con
ranura garantiza mayor
estabilidad y firmeza
Garantiza el montaje en
vertical.**



**Regulador de altura
asegura que el armario
siempre este a nivel.**

16

**Las opciones interiores
extraíbles (cajones,
estantes,...) deben respetar
esta distancia, desde el
costado donde cuelga la
puerta.**

16

**Cajones con sistema de
cierre amortiguado.**

**Extracción total y libre
configuración de altura de
costillas entre 11,16 y 22cm.**



MATERIALES ESTRUCTURA

Costados:	Grueso de 19mm, canteados con PVC de 0.8mm, los 4 costados..
Bucs superior e inferior:	Grueso de 30mm, canteados con PVC de 0.8mm.
Divisiones interiores:	Grueso de 30mm, canteados con PVC de 0.8mm, los 4 costados.
Trasera:	Grueso de 10mm.
Estantes interiores:	Grueso de 30mm, canteados con PVC de 0.8mm, los 4 costados.

COLORES DISPONIBLES

Carta de colores vigente de jotajotape



NUEVOS MATERIALES

Acabados STONE

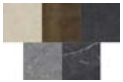

Acabados STONE solo disponible en grueso 19mm y 10mm. Canteado siempre en PVC 0.8mm. Disponible para frentes, traseras, forros, tapetas y tapas.

Acabados CRISTALES



Cristales con cantos pulidos de 4mm de grosor para puertas y 6mm para estantes. Para los acabados transparente, lacado, translucido y relieves, cristal templado y en el caso de espejos con lamina safe.

INFORMACIÓN TÉCNICA ESTRUCTURA

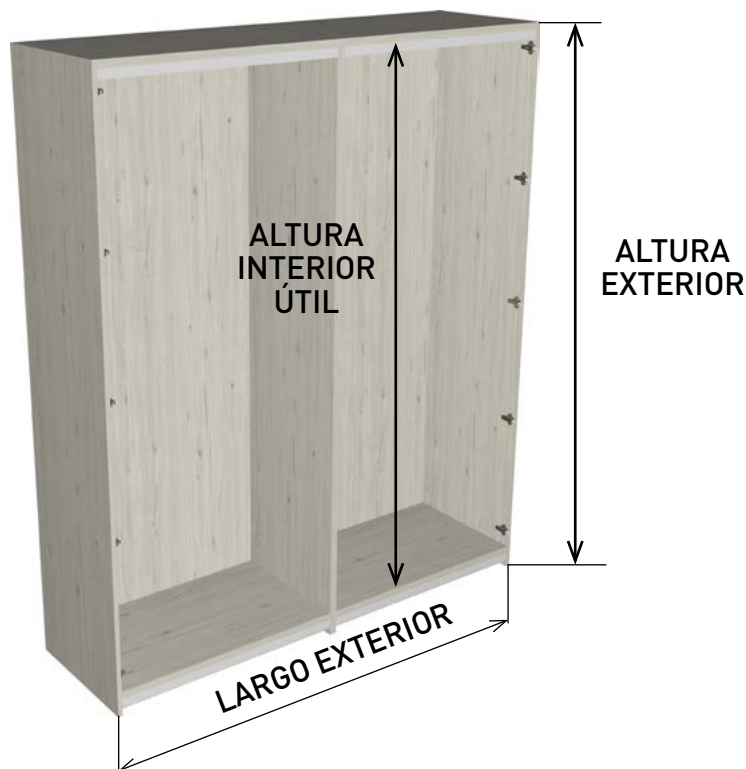

MEDIDAS A CONSIDERAR AL REALIZAR EL PEDIDO

$$\text{Altura interior útil} = \text{Altura armario} - 16,6\text{cm}$$

$$\text{Fondo mínimo armario (caja+puerta) para contener una cajonera} = 45\text{cm}$$

MEDIDAS MÍNIMAS NECESARIAS PARA MONTAJE

$$\text{Altura hueco} = \text{Altura exterior armario} + 3\text{cm}$$

$$\text{Largo hueco} = \text{Largo exterior armario} + 5\text{cm}$$

CARACTERÍSTICAS TÉCNICAS PUERTAS PLEGABLES

FRENTES



Sea cual sea la medida del armario todas las puertas mantienen la proporción.



Holgura inferior puerta 2mm sobre la caja, y 12mm del suelo al considerar el regulador. Igual que la línea del catálogo de mueble juvenil.

NUEVOS ACABADOS FRENTES



Se incorporan 5 nuevos acabados STONE, para dar un acento original y elegante.



Gran variedad de acabados cristal, a escoger entre transparentes, translúcidos, lacados, relieve y espejos.

SISTEMA APERTURA PLEGABLE

El catálogo NOLIMITS NEXT incorpora un nuevo sistema de puerta plegable. Se eleva la base de la estructura para poder incorporar una guía inferior. La doble guía ofrece un deslizamiento optimizado, y una mayor suavidad en la apertura y cierre.



Se mejoran las bisagras entrepuertas simplificando el proceso de montaje de la puerta sujeta a las guías.



NUEVOS MODELOS DE PUERTAS



ONIX



RELIEF



LUX

PASOS PARA CONFECCIONAR UN ARMARIO

1. Elegir caja

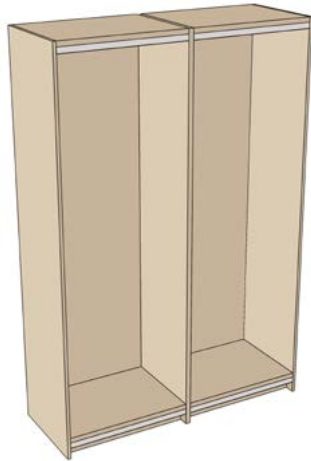

SIN DISTRIBUCIÓN INTERIOR

2. Elegir puertas



de pág.95 a pág. 108

3. Opciones

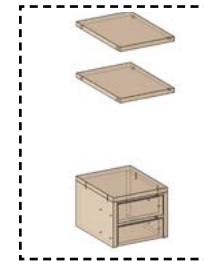

de pág.
109 a 122

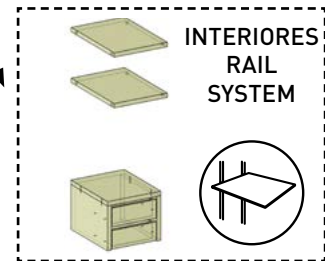

de pág.
123 a 132

IMPRESINDIBLE ENVIAR DIBUJO DE LA DISTRIBUCIÓN INTERIOR.

MEDIDAS ESPECIALES

Elegir la medida superior y cortar, sin incremento.

CAJAS ARMARIO

La caja del armario no incluye estantes ni barra para colgar.
En todos los casos el fondo 60cm indica la caja de 58cm + el grosor de las puertas.

MONTAJE

Para montar un armario en un hueco es necesario disponer de **5cm** libres para su montaje lateral, y de **3cm** libres para su montaje superior. Si es posible montar el armario e introducir éste en el hueco, no hace falta disponer de las distancias marcadas anteriormente.

REGULACIÓN

Información importante

Regulación entre 10 y 30mm para compensar desvío de suelo. Estos 10mm se deben tener en cuenta para la altura total (no están contabilizados en las medidas de tarifa)



IMPORTANTE Sin equipamiento interior.

Ejemplo: 1. Elegir caja

El cliente desea un armario de 195 cm, de 239 cm de altura

Buscar la caja superior, en este caso 200 cm, que tiene dos cuerpos y su altura correspondiente.

200

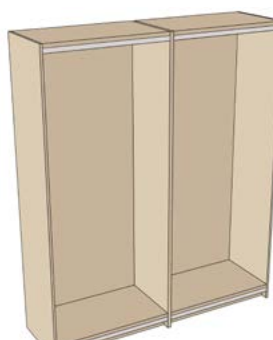

Altura	Ref.	Puntos
239	ARP204	494
260	ARP204	524
280	ARP204	539

Que características tiene el armario y cual es su valor en puntos.

Con la referencia **ARP204** tenemos un armario de **195** cm ancho y **239** cm alto.

El espacio interior que nos queda es menor que el del armario de 200 y las puertas lógicamente también quedan más pequeñas, pero **siempre todas iguales**.

No hay incremento en los puntos por cortar el armario, por eso su valor es **494 puntos**.

En resumen:

Solo se tiene que elegir **ARP204** a **195 cm** y jotajotape se encarga del resto.

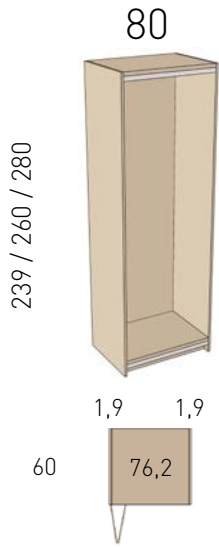

Altura	Ref.	Puntos
239	ARP84Z	246
260	ARP86Z	277
280	ARP88Z	293

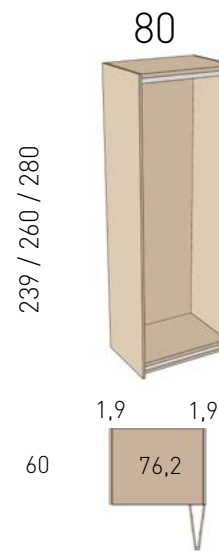

Altura	Ref.	Puntos
239	ARP84D	246
260	ARP86D	277
280	ARP88D	293

Puertas de ancho 39,7.

Puertas de ancho 39,7.

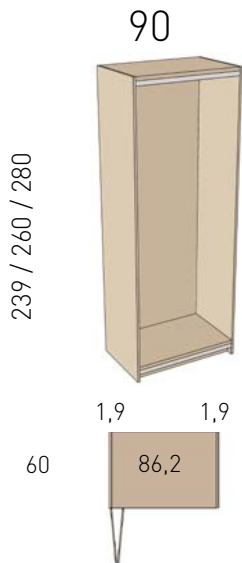

Altura	Ref.	Puntos
239	ARP94Z	260
260	ARP96Z	277
280	ARP98Z	310

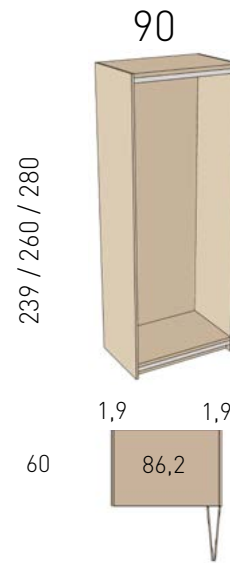

Altura	Ref.	Puntos
239	ARP94D	260
260	ARP96D	277
280	ARP98D	310

Puertas de ancho 44,7.

Puertas de ancho 44,7.

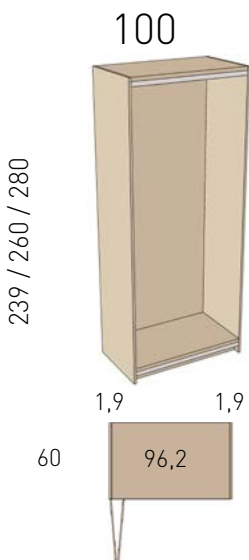

Altura	Ref.	Puntos
239	ARP104Z	276
260	ARP106Z	307
280	ARP108Z	323

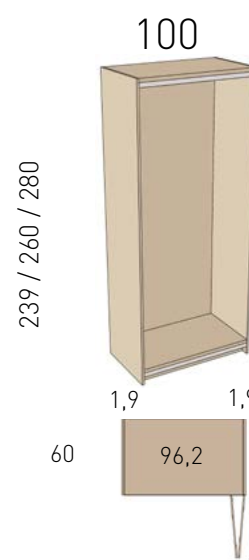

Altura	Ref.	Puntos
239	ARP104D	276
260	ARP106D	307
280	ARP108D	323

Puertas de ancho 49,7.

Puertas de ancho 49,7.

A partir de medidas interiores superiores a 120, no se puede introducir ni barra ni estante (sin separador).
Para medidas intermedias, coger referencia de medida superior y cortar. Sin incremento por especial.



110

239 / 260 / 280

1,9 1,9

60 106,2

Puertas de ancho 54,7.

Altura	Ref.	Puntos
239	ARP114Z	294
260	ARP116Z	322
280	ARP118Z	338

110

239 / 260 / 280

1,9 1,9

60 106,2

Puertas de ancho 54,7.

Altura	Ref.	Puntos
239	ARP114D	294
260	ARP116D	322
280	ARP118D	338

120

239 / 260 / 280

1,9 1,9

60 116,2

Puertas de ancho 59,7.

Altura	Ref.	Puntos
239	ARP124Z	314
260	ARP126Z	342
280	ARP128Z	358

120

239 / 260 / 280

1,9 1,9

60 116,2

Puertas de ancho 59,7.

Altura	Ref.	Puntos
239	ARP124D	314
260	ARP126D	342
280	ARP128D	358

130

239 / 260 / 280

1,9 3 1,9

60 61,6 61,6

Puertas de ancho 32,2.

Altura	Ref.	Puntos
239	ARP134	370
260	ARP136	400
280	ARP138	425

140

239 / 260 / 280

1,9 3 1,9

60 66,6 66,6

Puertas de ancho 34,7.

Altura	Ref.	Puntos
239	ARP144	392
260	ARP146	422
280	ARP148	437

A partir de medidas interiores superiores a 120, no se puede introducir ni barra ni estante (sin separador).
 Para medidas intermedias, coger referencia de medida superior y cortar. Sin incremento por especial.



150

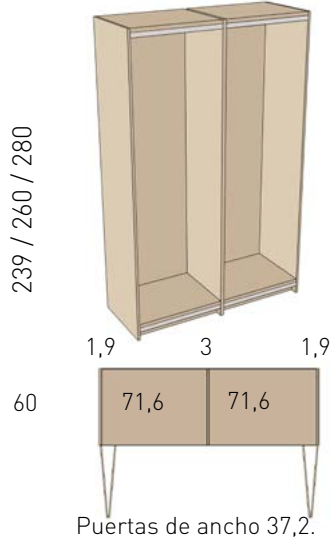

Altura	Ref.	Puntos
239	ARP154	414
260	ARP156	444
280	ARP158	459

160

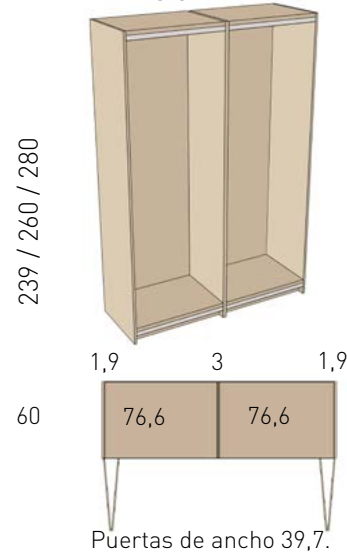

Altura	Ref.	Puntos
239	ARP164	436
260	ARP166	466
280	ARP168	481

170

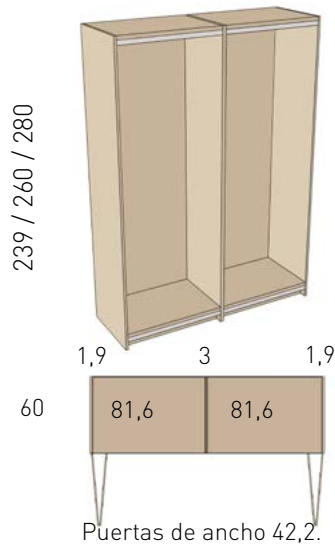

Altura	Ref.	Puntos
239	ARP174	458
260	ARP176	488
280	ARP178	503

180

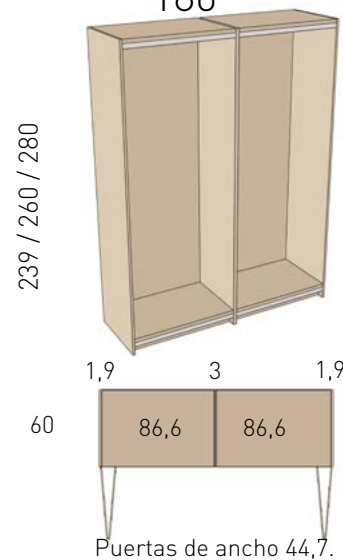

Altura	Ref.	Puntos
239	ARP184	480
260	ARP186	510
280	ARP188	525

190

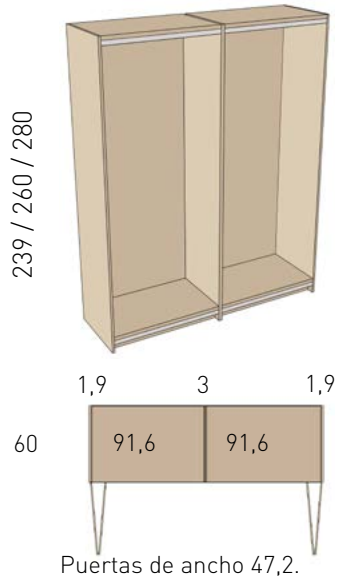

Altura	Ref.	Puntos
239	ARP194	502
260	ARP196	532
280	ARP198	547

200

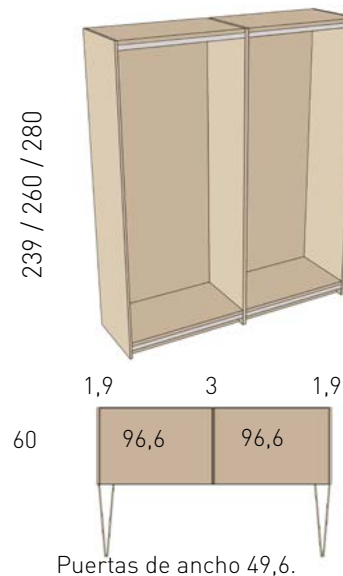

Altura	Ref.	Puntos
239	ARP204	524
260	ARP206	554
280	ARP208	569

A partir de medidas interiores superiores a 120, no se puede introducir ni barra ni estante (sin separador).
Para medidas intermedias, coger referencia de medida superior y cortar. Sin incremento por especial.



210

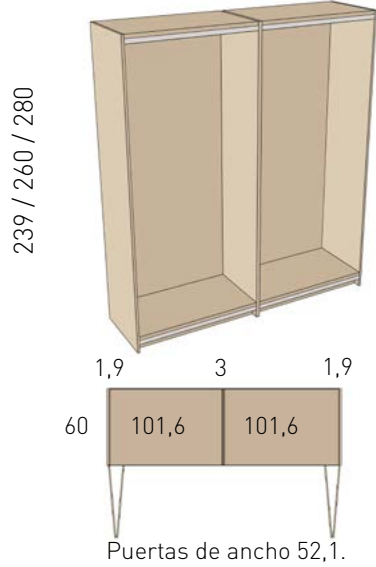

Altura	Ref.	Puntos
239	ARP214	546
260	ARP216	576
280	ARP218	591

220

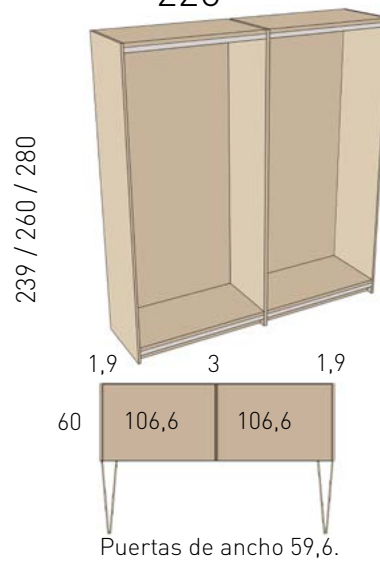

Altura	Ref.	Puntos
239	ARP224	568
260	ARP226	598
280	ARP228	613

230

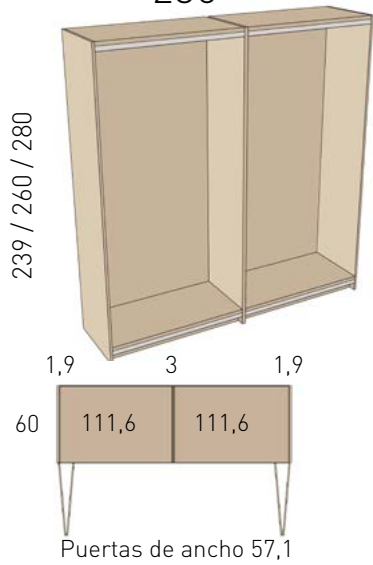

Altura	Ref.	Puntos
239	ARP234	590
260	ARP236	620
280	ARP238	635

240

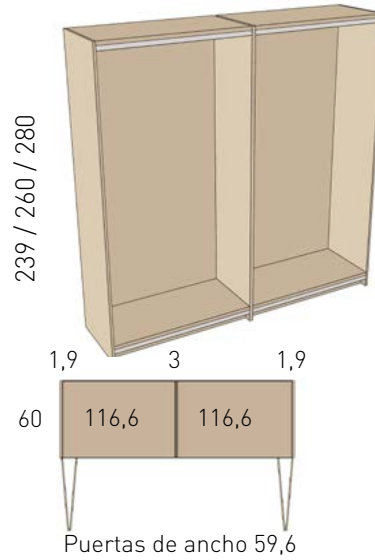

Altura	Ref.	Puntos
239	ARP244	612
260	ARP246	642
280	ARP248	657

250

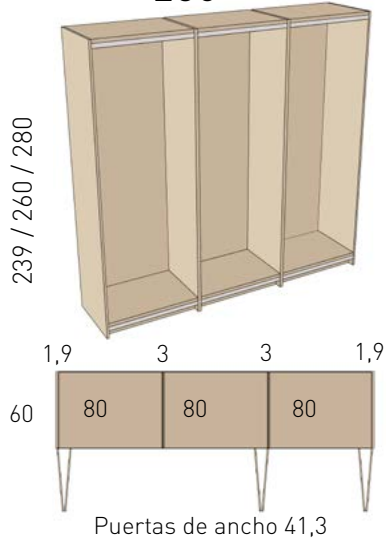

Altura	Ref.	Puntos
239	ARP254	680
260	ARP256	720
280	ARP258	735

260

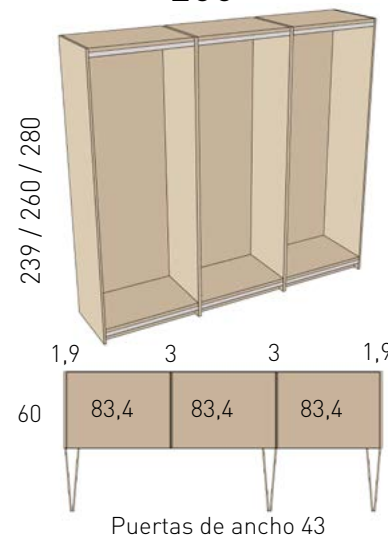

Altura	Ref.	Puntos
239	ARP264	696
260	ARP266	742
280	ARP268	770

A partir de medidas interiores superiores a 120, no se puede introducir ni barra ni estante (sin separador).
Para medidas intermedias, coger referencia de medida superior y cortar. Sin incremento por especial.

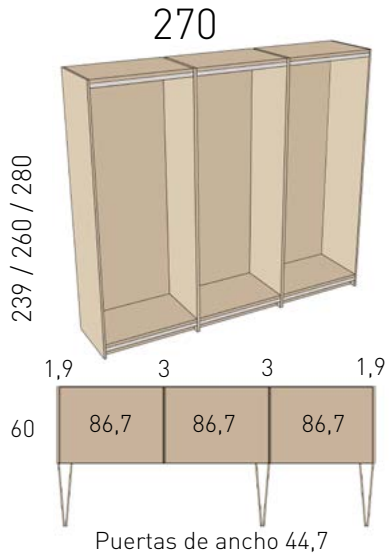

Altura	Ref.	Puntos
239	ARP274	712
260	ARP276	764
280	ARP278	804

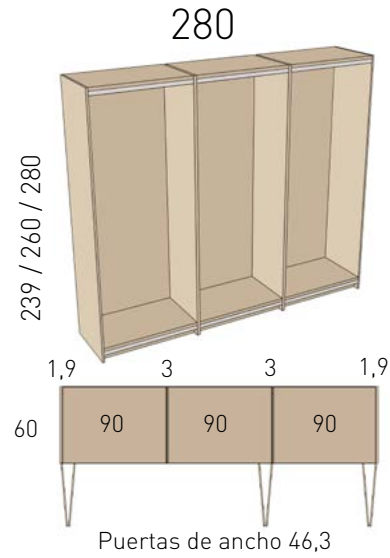

Altura	Ref.	Puntos
239	ARP284	728
260	ARP286	786
280	ARP288	840

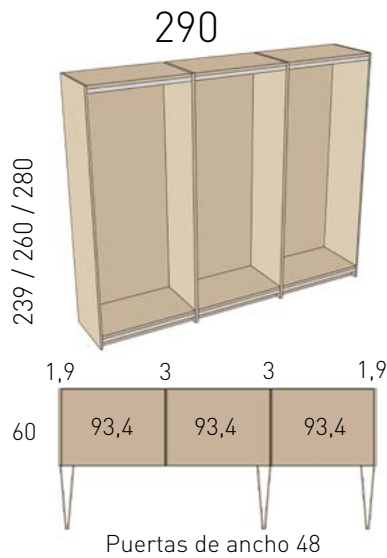

Altura	Ref.	Puntos
239	ARP294	744
260	ARP296	808
280	ARP298	874

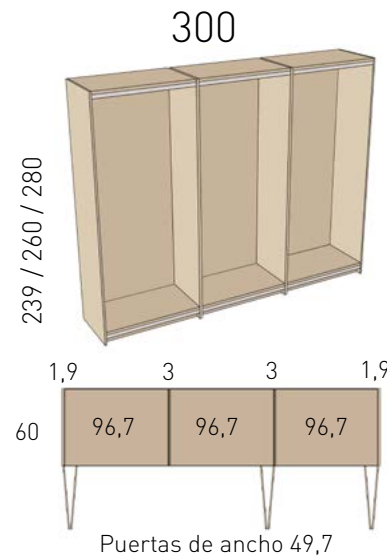

Altura	Ref.	Puntos
239	ARP304	760
260	ARP306	832
280	ARP308	906

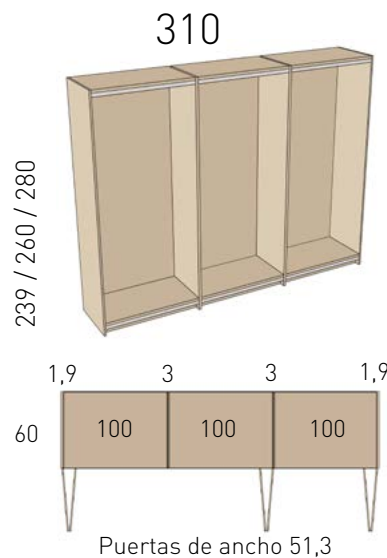

Altura	Ref.	Puntos
239	ARP314	776
260	ARP316	856
280	ARP318	938

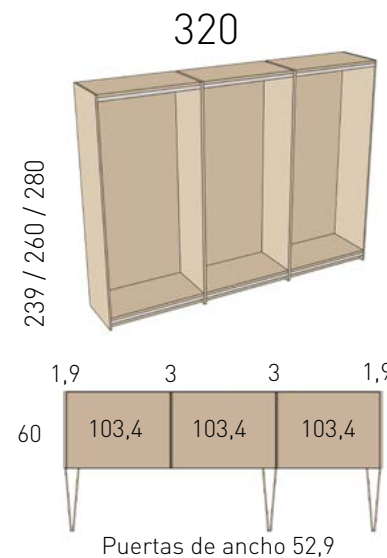

Altura	Ref.	Puntos
239	ARP324	792
260	ARP326	880
280	ARP328	970

A partir de medidas interiores superiores a 120, no se puede introducir ni barra ni estante (sin separador).
Para medidas intermedias, coger referencia de medida superior y cortar. Sin incremento por especial.

330

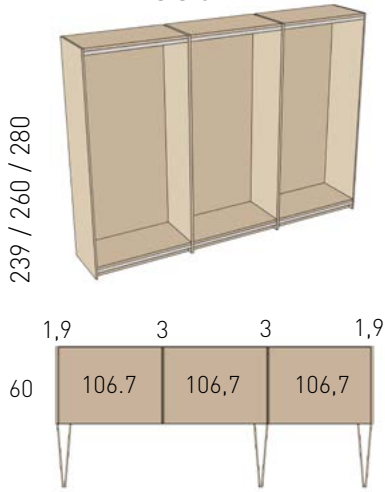

Altura	Ref.	Puntos
239	ARP334	808
260	ARP336	904
280	ARP338	1002

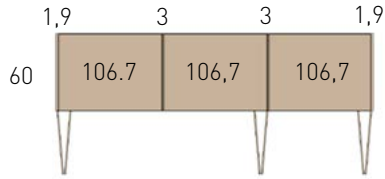

Puertas de ancho 54,6

340

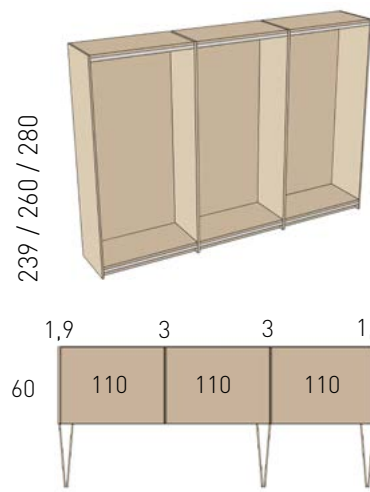

Altura	Ref.	Puntos
239	ARP344	824
260	ARP346	928
280	ARP348	1034

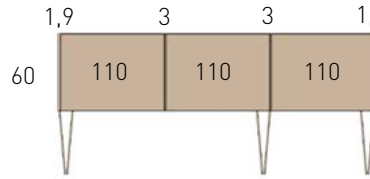

Puertas de ancho 56,3

350

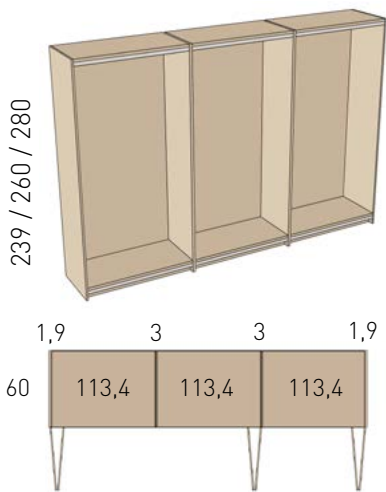

Altura	Ref.	Puntos
239	ARP354	840
260	ARP356	952
280	ARP358	1066

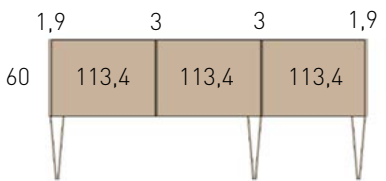

Puertas de ancho 57,9

360

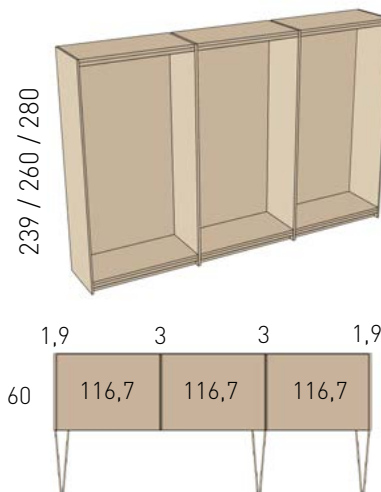

Altura	Ref.	Puntos
239	ARP364	856
260	ARP366	976
280	ARP368	1098

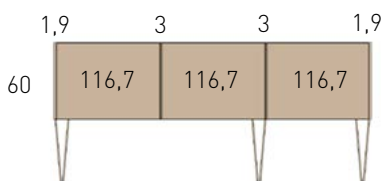

Puertas de ancho 59,6

370

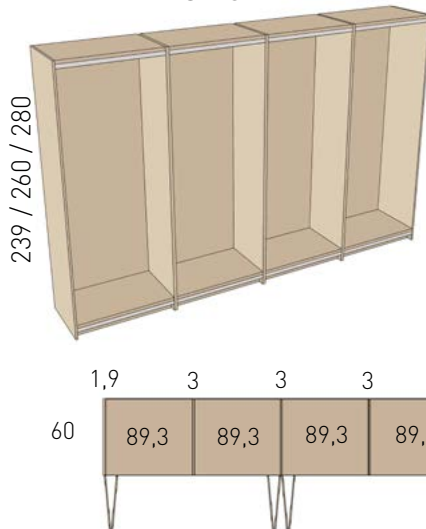

Altura	Ref.	Puntos
239	ARP374	924
260	ARP376	1048
280	ARP378	1111

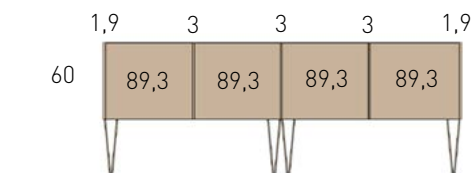

Puertas de ancho 45,9.

380

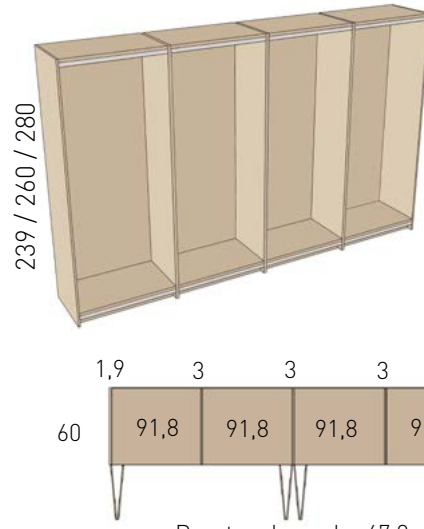

Altura	Ref.	Puntos
239	ARP384	950
260	ARP386	1080
280	ARP388	1142

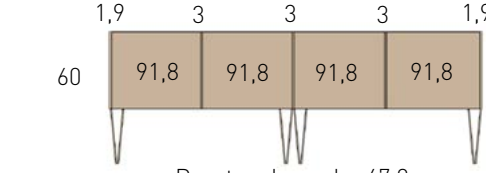

Puertas de ancho 47,2.

A partir de medidas interiores superiores a 120, no se puede introducir ni barra ni estante (sin separador).
Para medidas intermedias, coger referencia de medida superior y cortar. Sin incremento por especial.



390

Altura	Ref.	Puntos
239	ARP394	974
260	ARP396	1110
280	ARP398	1174

Puertas de ancho 48,4.

400

Altura	Ref.	Puntos
239	ARP404	1000
260	ARP406	1140
280	ARP408	1206

Puertas de ancho 49,7.

410

Altura	Ref.	Puntos
239	ARP414	1026
260	ARP416	1170
280	ARP418	1238

Puertas de ancho 50,8

420

Altura	Ref.	Puntos
239	ARP424	1052
260	ARP426	1200
280	ARP428	1270

Puertas de ancho 52,1

430

Altura	Ref.	Puntos
239	ARP434	1078
260	ARP436	1230
280	ARP438	1302

Puertas de ancho 53,3

440

Altura	Ref.	Puntos
239	ARP444	1104
260	ARP446	1260
280	ARP448	1334

Puertas de ancho 54,6

A partir de medidas interiores superiores a 120, no se puede introducir ni barra ni estante (sin separador).
 Para medidas intermedias, coger referencia de medida superior y cortar. Sin incremento por especial.



450

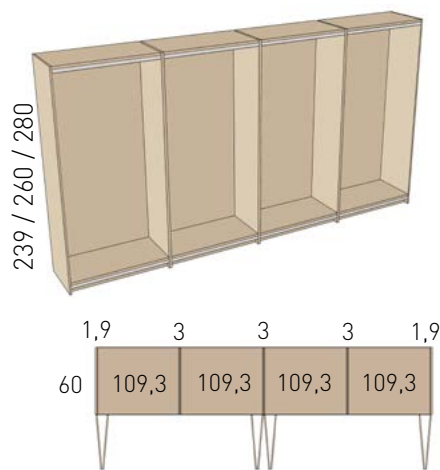

Altura	Ref.	Puntos
239	ARP454	1130
260	ARP456	1290
280	ARP458	1366

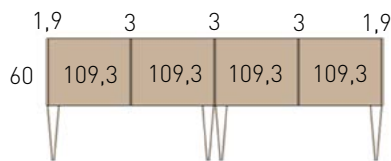

Puertas de ancho 55,8

460

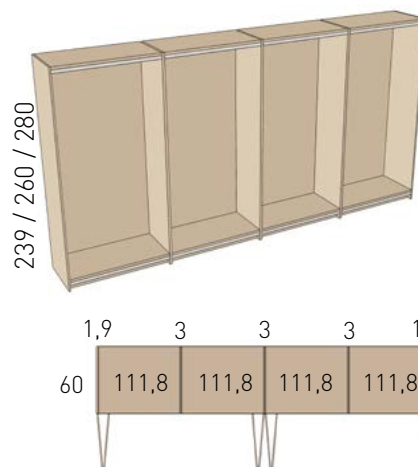

Altura	Ref.	Puntos
239	ARP464	1156
260	ARP466	1320
280	ARP468	1398

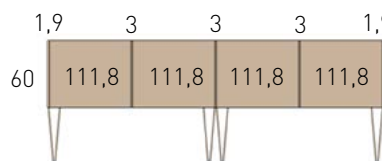

Puertas de ancho 57,1

470

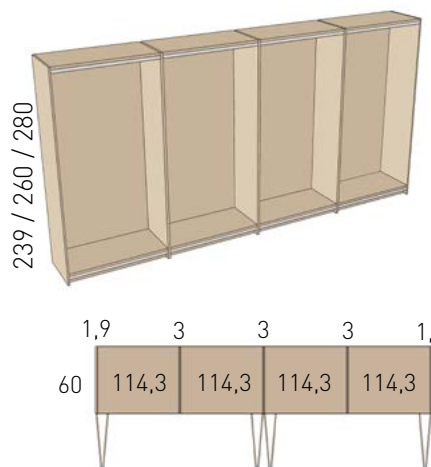

Altura	Ref.	Puntos
239	ARP474	1182
260	ARP476	1350
280	ARP478	1430

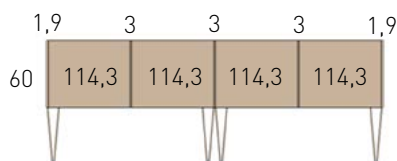

Puertas de ancho 58,3

480

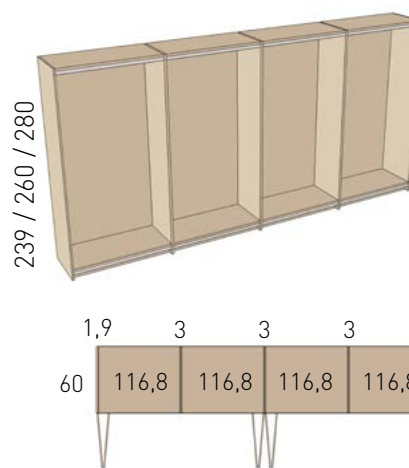

Altura	Ref.	Puntos
239	ARP484	1208
260	ARP486	1380
280	ARP488	1462

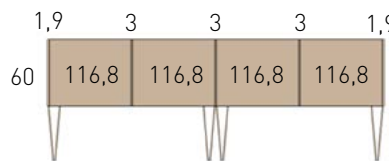

Puertas de ancho 59,6

A partir de medidas interiores superiores a 120, no se puede introducir ni barra ni estante (sin separador).
Para medidas intermedias, coger referencia de medida superior y cortar. Sin incremento por especial.



Por cada cajeadado incrementar 195 puntos

CON EQUIPAMIENTO INTERIOR
AÑADIR PUERTAS
 Cajoneras no compatibles

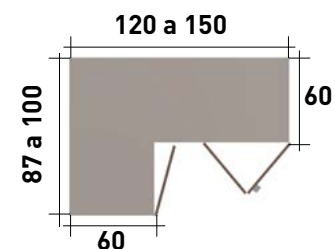
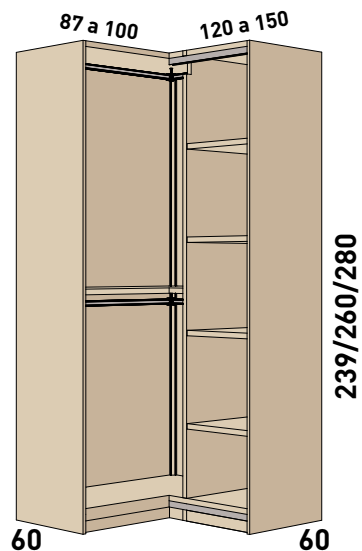

Cuerpos para:
 2 hojas plegables
 +
 1 batiente

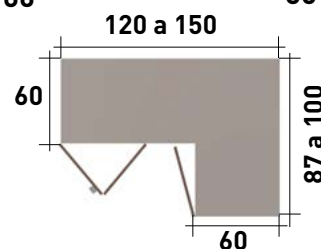
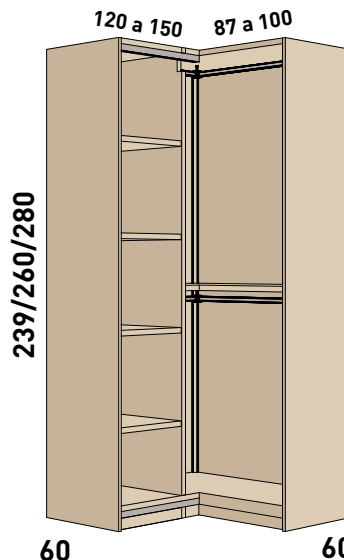

Altura	Ref.	Puntos
239	ARP4D	853
260	ARP6D	907
280	ARP8D	945

Altura	Ref.	Puntos
239	ARP4Z	853
260	ARP6Z	907
280	ARP8Z	945

EJEMPLO SELECCIÓN DE PUERTAS

El cliente desea unas puertas para un armario de 195 cm, de 239 cm de altura

Buscar las puertas deseadas, en este caso elegimos la de 1 plafón, con sus colores, su altura y el rango de medida.

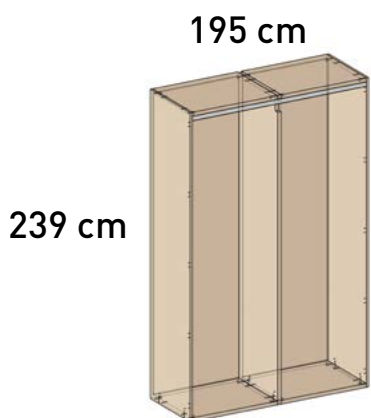

Puertas para armario de 2 cuerpos

Apertura IZQUIERDA

Apertura DERECHA

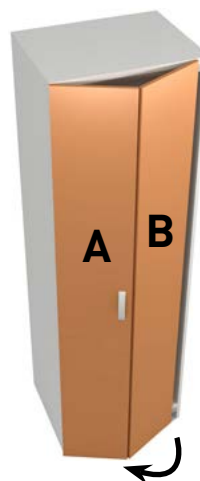

Conjunto dos puertas de 60 a 120

Conjunto dos puertas de 60 a 120

A	Acabados BASE		Acabados STONE		
	Altura	Ref	Puntos	Ref	Puntos
	239	PGA404	102	PSA404	109
	260	PGA406	108	PSA406	115
	280	PGA408	111	PSA408	119
B					
	239	PGB404	98	PSB404	105
	260	PGB406	104	PSB406	111
	280	PGB408	107	PSB408	115

C	Acabados BASE		Acabados STONE		
	Altura	Ref	Puntos	Ref	Puntos
	239	PGC404	98	PSC404	105
	260	PGC406	104	PSC406	111
	280	PGC408	107	PSC408	115
D					
	239	PGD404	102	PSD404	109
	260	PGD406	108	PSD406	115
	280	PGD408	111	PSD408	119

Tenemos 4 referencias (una por hoja): PGA404, PGB404, PGC404 y PGD404 todas iguales adaptadas al armario de 195.

No hay incremento en los puntos por modificar las puertas, por eso nos quedan 400 puntos (las 4 puertas).

Lisas

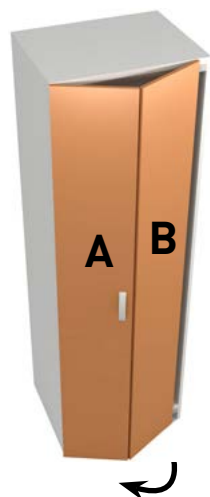

Apertura IZQUIERDA

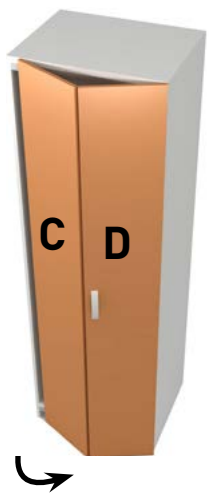

Apertura DERECHA

Puerta mínima 25
Puerta máxima 60

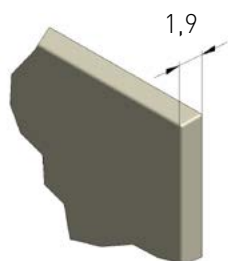

A	Acabados BASE		Acabados STONE	
	Ref	Puntos	Ref	Puntos
Altura				
239	PGA404	102	PSA404	109
260	PGA406	108	PSA406	115
280	PGA408	111	PSA408	119
B				
239	PGB404	98	PSB404	105
260	PGB406	104	PSB406	111
280	PGB408	107	PSB408	115
C				
239	PGC404	98	PSC404	105
260	PGC406	104	PSC406	111
280	PGC408	107	PSC408	115
D				
239	PGD404	102	PSD404	109
260	PGD406	108	PSD406	115
280	PGD408	111	PSD408	119

Acabados



Altura máxima
acabado STONE
277cm

Acabados STONE
canteados con
PVC de 0.8mm

Tiradores

Belt	Anello	Ark largo	Dito	Testa 20/30cm
+0	+0	+8	+0	+0

Acabados Tiradores



Rústica



Puerta mínima 25
Puerta máxima 60

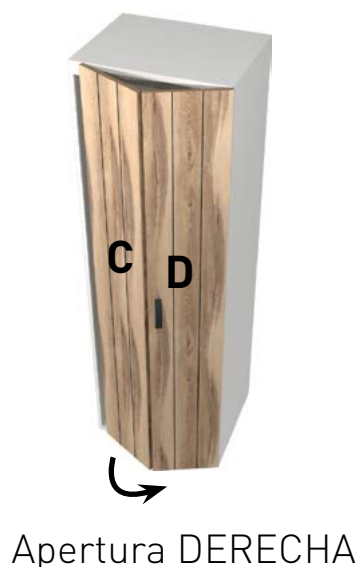
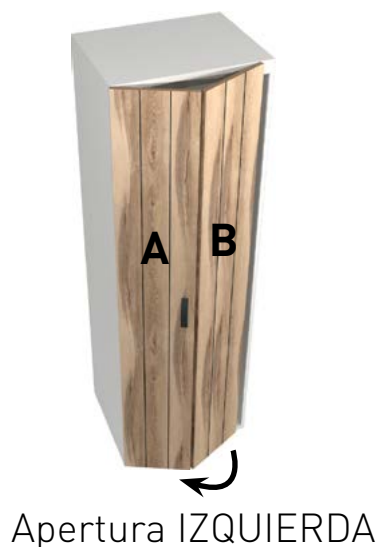

Dos ranuras de 2 mm de
ancho por puerta.

 **INCREMENTO
POR RANURA
ADICIONAL +7**

Acabados Ranura



*Indica el color de la ranura.

A	Acabados BASE		Acabados STONE	
	Ref	Puntos	Ref	Puntos
239	PGA414	130	PSA414	137
260	PGA416	134	PSA416	141
280	PGA418	138	PSA418	148
B				
239	PGB414	126	PSB414	133
260	PGB416	130	PSB416	137
280	PGB418	134	PSB418	142
C				
239	PGC414	126	PSC414	133
260	PGC416	130	PSC416	137
280	PGC418	134	PSC418	142
D				
239	PGD414	130	PSD414	137
260	PGD416	134	PSD416	141
280	PGD418	138	PSD418	148

Acabados



Altura máxima
acabado STONE
277cm

Acabados STONE
cantedos con
PVC de 0.8mm

Tiradores

				
Belt	Anello	Ark largo	Dito	Testa 20/30cm
+0	+0	+8	+0	+0

Acabados Tiradores



ONIX



Puerta mínima 25
Puerta máxima 60



Apertura IZQUIERDA

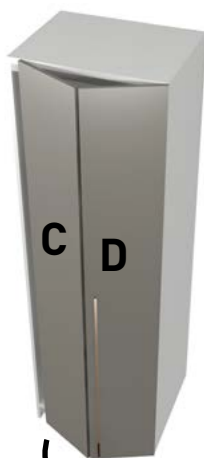

Apertura DERECHA

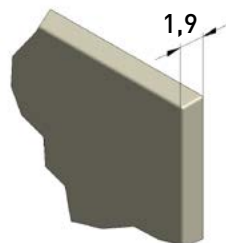
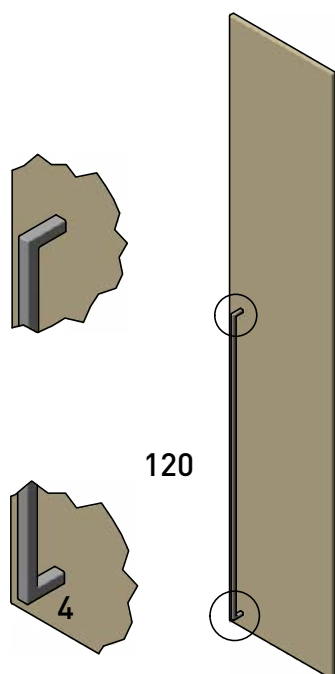

A	Acabados BASE		Acabados STONE	
	Ref	Puntos	Ref	Puntos
Altura				
239	PGA464	130	PSA464	137
260	PGA466	136	PSA466	143
280	PGA468	147	PSA468	155
B				
239	PGB464	105	PSB464	112
260	PGB466	111	PSB466	118
280	PGB468	115	PSB468	123
C				
239	PGC464	105	PSC464	112
260	PGC466	111	PSC466	118
280	PGC468	115	PSC468	123
D				
239	PGD464	130	PSD464	137
260	PGD466	136	PSD466	143
280	PGD468	147	PSD468	155

Acabados



Altura máxima
acabado STONE
277cm

Acabados STONE
canteados con
PVC de 0.8mm

Único TIRADOR incorporado

Acabados
Tiradores



Iris



Puerta mínima 25
Puerta máxima 60

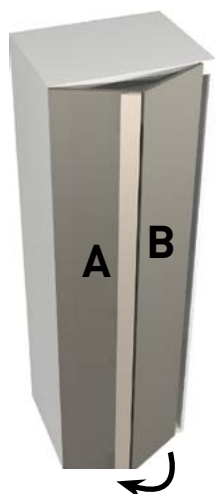

Apertura IZQUIERDA

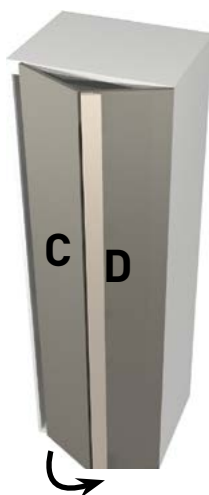

Apertura DERECHA

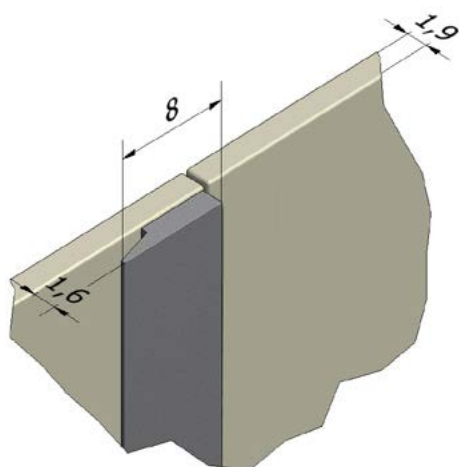

A	Acabados BASE		Acabados STONE	
	Ref	Puntos	Ref	Puntos
239	PGA424	140	PSA424	147
260	PGA426	148	PSA426	155
280	PGA428	153	PSA428	161
B				
239	PGB424	98	PSB424	105
260	PGB426	104	PSB426	111
280	PGB428	107	PSB428	115
C				
239	PGC424	98	PSC424	105
260	PGC426	104	PSC426	111
280	PGC428	107	PSC428	115
D				
239	PGD424	140	PSD424	147
260	PGD426	148	PSD426	155
280	PGD428	153	PSD428	161

Acabados



Altura máxima
acabado STONE
277cm

Acabados STONE
canteados con
PVC de 0.8mm

Único TIRADOR incorporado

Acabados
Tiradores



Vertical

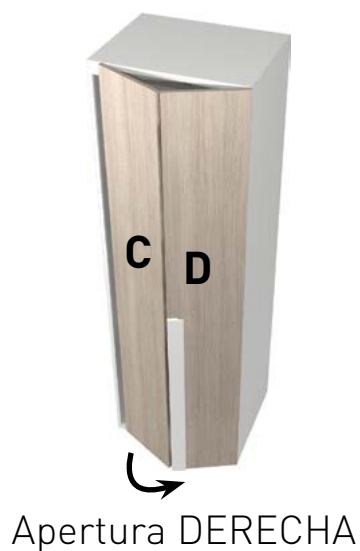
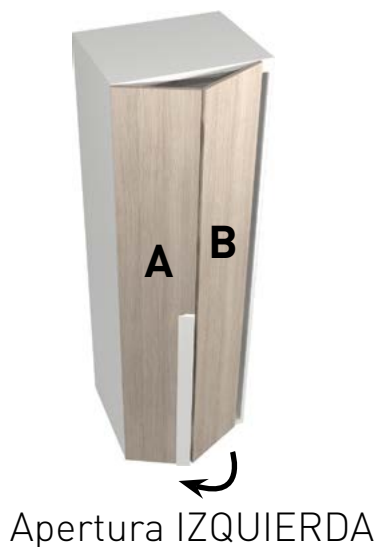

Puerta mínima 25
Puerta máxima 60

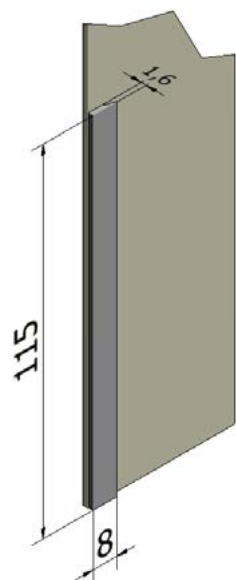

A	Acabados BASE		Acabados STONE	
	Ref	Puntos	Ref	Puntos
Altura				
239	PGA434	117	PSA434	124
260	PGA436	123	PSA436	130
280	PGA438	126	PSA438	134
B				
239	PGB434	98	PSB434	105
260	PGB436	104	PSB436	111
280	PGB438	107	PSB438	115
C				
239	PGC434	98	PSC434	105
260	PGC436	104	PSC436	111
280	PGC438	107	PSC438	115
D				
239	PGD434	117	PSD434	124
260	PGD436	123	PSD436	130
280	PGD438	126	PSD438	134

Acabados



Altura máxima
acabado STONE
277cm

Acabados STONE
canteados con
PVC de 0.8mm

Único TIRADOR incorporado

Acabados
Tiradores



Relief 10



Puerta mínima 25
Puerta máxima 60

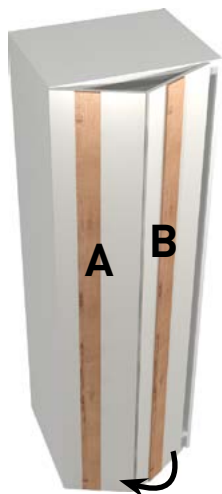

Apertura IZQUIERDA

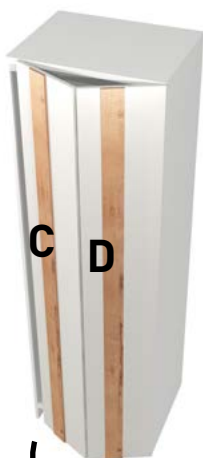

Apertura DERECHA

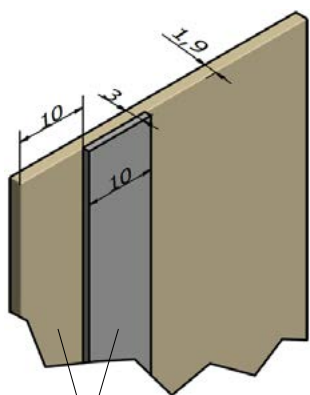
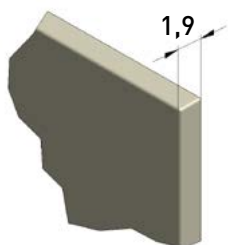

* Medidas fijas

A	Acabados BASE		
	Altura	Ref	Puntos
A	239	PGA444	136
	260	PGA446	165
	280	PGA448	171
B	239	PGB444	132
	260	PGB446	161
	280	PGB448	167
C	239	PGC444	132
	260	PGC446	161
	280	PGC448	167
D	239	PGD444	136
	260	PGD446	165
	280	PGD448	171

Acabados



Acabados Franja



Tiradores

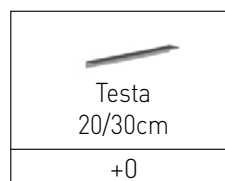

Acabados STONE para franja incremento +5 puntos alto máximo 277cm

Acabados Tiradores



Relief 20



Puerta mínima 25
Puerta máxima 60

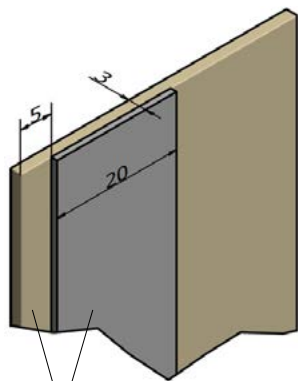
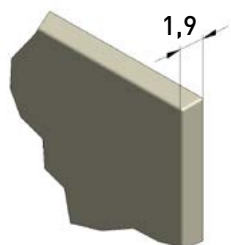
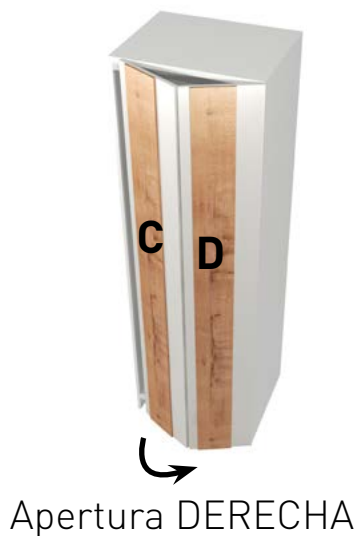
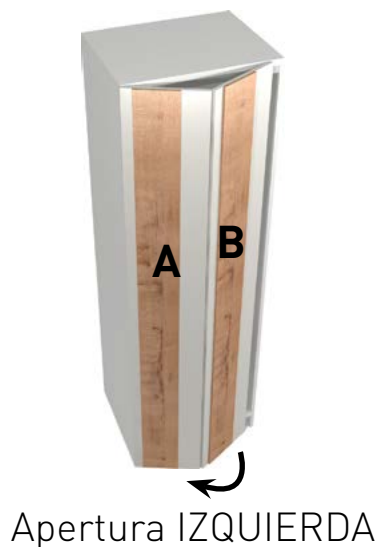

* Medidas fijas

A	Acabados BASE		
	Altura	Ref	Puntos
A	239	PGA454	146
	260	PGA456	175
	280	PGA458	181
B	239	PGB454	142
	260	PGB456	171
	280	PGB458	177
C	239	PGC454	142
	260	PGC456	171
	280	PGC458	177
D	239	PGD454	146
	260	PGD456	175
	280	PGD458	181

Acabados



Acabados Franja



Acabados STONE para franja incremento +5 alto máximo 277cm

Tiradores

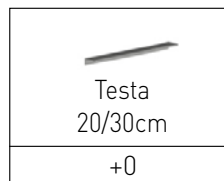

Acabados Tiradores



Enmarcada 1 Plafón



Puerta mínima 25
Puerta máxima 60

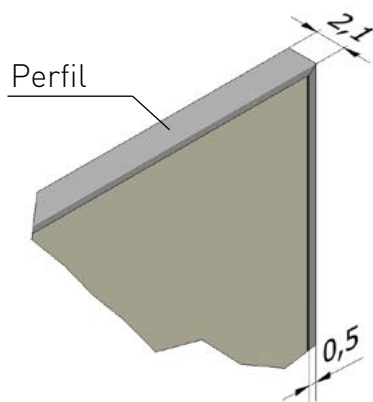

Acabados Perfil

A	Acabados BASE		Acabados STONE	
	Ref	Puntos	Ref	Puntos
Altura				
239	PGA484	172	PSA484	179
260	PGA486	182	PSA486	189
280	PGA488	187	PSA488	195
B				
239	PGB484	168	PSB484	175
260	PGB486	178	PSB486	185
280	PGB488	183	PSB488	191
C				
239	PGC484	168	PSC484	175
260	PGC486	178	PSC486	185
280	PGC488	183	PSC488	191
D				
239	PGD484	172	PSD484	179
260	PGD486	182	PSD486	189
280	PGD488	187	PSD488	195

Acabados



Altura máxima acabado STONE 277cm

Acabados STONE canteados con PVC de 0.8mm

Tiradores

Belt	Anello	Ark largo	Dito	Testa 20/30cm
+0	+0	+8	+0	+0

Acabados Tiradores



Enmarcada 3 plafones iguales

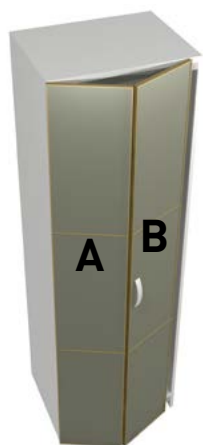

Apertura IZQUIERDA



Apertura DERECHA

Puerta mínima 25
Puerta máxima 60

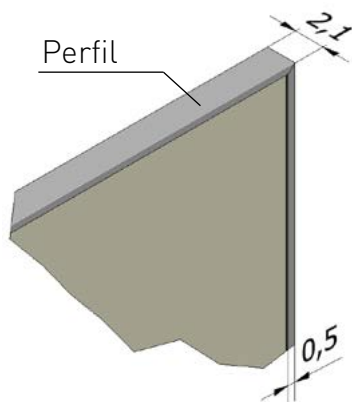

Acabados Perfil



A	Acabados BASE		Acabados STONE	
	Ref	Puntos	Ref	Puntos
Altura				
239	PGA494	175	PSA494	182
260	PGA496	185	PSA496	192
280	PGA498	190	PSA498	198
B				
239	PGB494	171	PSB494	178
260	PGB496	181	PSB496	188
280	PGB498	186	PSB498	194
C				
239	PGC494	171	PSC494	178
260	PGC496	181	PSC496	188
280	PGC498	186	PSC498	194
D				
239	PGD494	175	PSD494	182
260	PGD496	185	PSD496	192
280	PGD498	190	PSD498	198

Acabados



Altura máxima
acabado STONE
277cm

Acabados STONE
canteados con
PVC de 0.8mm

Tiradores

Belt	Anello	Ark largo	Dito	Testa 20/30cm
+0	+0	+8	+0	+0

Acabados Tiradores



Enmarcada 3 plafones Combinables



Puerta mínima 25
Puerta máxima 60

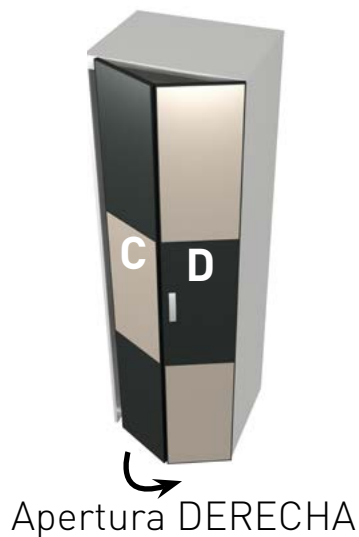
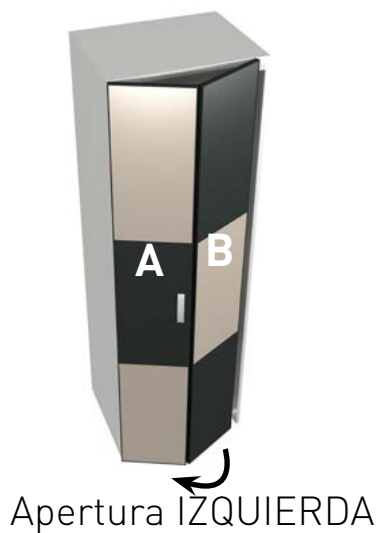

A	Acabados BASE		
	Altura	Ref	Puntos
A	239	PGA504	202
	260	PGA506	214
	280	PGA508	223
B	239	PGB504	198
	260	PGB506	210
	280	PGB508	219
C	239	PGC504	198
	260	PGC506	210
	280	PGC508	219
D	239	PGD504	202
	260	PGD506	214
	280	PGD508	223

Acabados

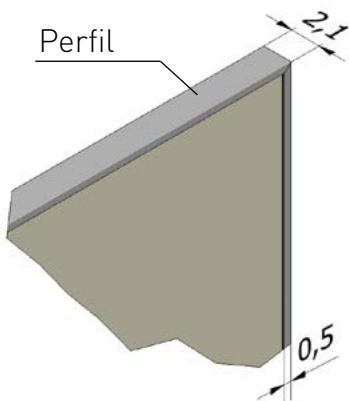

Acabados Perfil



Tiradores

Belt	Anello	Ark largo	Dito	Testa 20/30cm
+0	+0	+8	+0	+0

Acabados Tiradores



Desigual



Puerta mínima 25
Puerta máxima 60

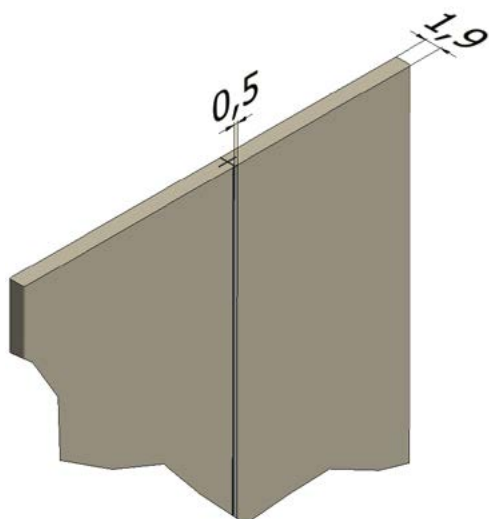
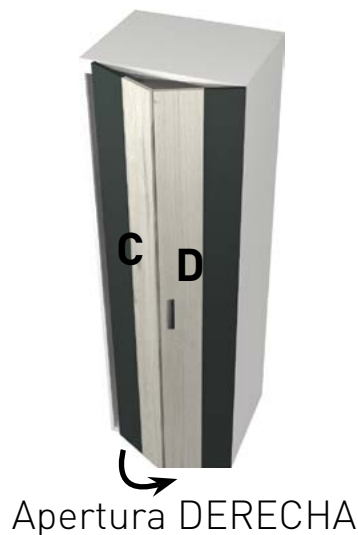
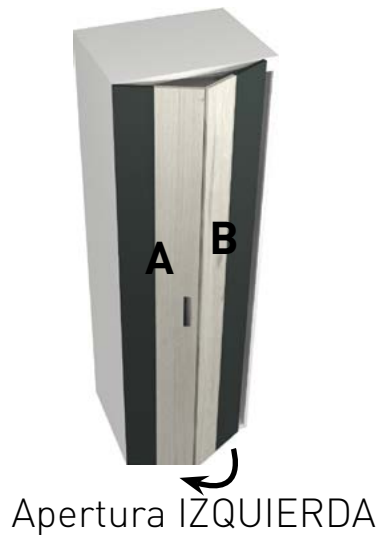

A	Acabados BASE		
	Altura	Ref	Puntos
A	239	PGA474	182
	260	PGA476	194
	280	PGA478	202
B	239	PGB474	178
	260	PGB476	190
	280	PGB478	198
C	239	PGC474	178
	260	PGC476	190
	280	PGC478	198
D	239	PGD474	182
	260	PGD476	194
	280	PGD478	202

Acabados



Tiradores

Belt	Anello	Ark largo	Dito	Testa 20/30cm
+0	+0	+8	+0	+0

Acabados Tiradores



LUX

No recomendamos combinar con otros modelos de puertas enmarcadas.

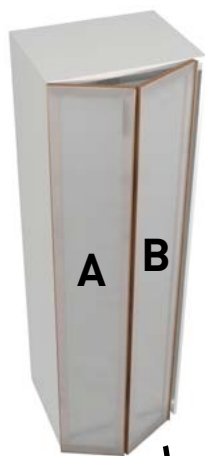

Apr. IZQUIERDA

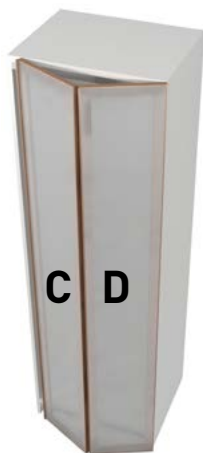

Apr. DERECHA

Puerta mínima 25
Puerta máxima 60

Perfil

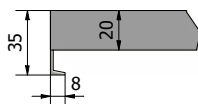
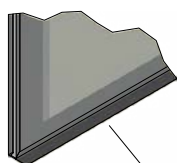
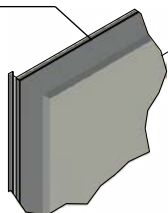

A	Acabados CRISTAL		Acabados BASE		Acabados STONE	
	Ref	Puntos	Ref	Puntos	Ref	Puntos
Altura						
239	PVA514	364	PGA514	234	PSA514	241
260	PVA516	384	PGA516	246	PSA516	253
280	PVA518	404	PGA518	258	PSA518	266
B						
239	PVB514	360	PGB514	230	PSB514	237
260	PVB516	380	PGB516	242	PSB516	249
280	PVB518	400	PGB518	254	PSB518	262
C						
239	PVC514	360	PGC514	230	PSC514	237
260	PVC516	380	PGC516	242	PSC516	249
280	PVC518	400	PGC518	254	PSC518	262
D						
239	PVD514	364	PGD514	234	PSD514	241
260	PVD516	384	PGD516	246	PSD516	253
280	PVD518	404	PGD518	258	PSD518	266

Acabados

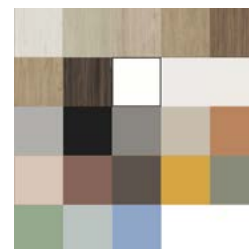

Altura máxima acabado STONE 277cm

Acabados STONE canteados con PVC de 0.8mm

Único TIRADOR incorporado

Acabados Perfil



Led con batería

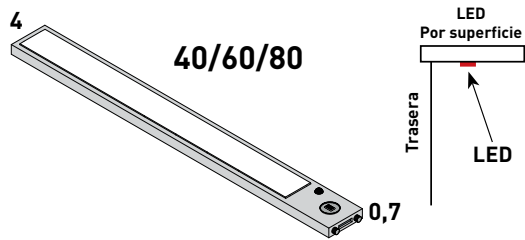

L	Ref.	Puntos
40	LB40	48
60	LB60	65
80	LB80	85

Sistema con batería recargable USB, configuración activación sensor de movimiento, control de color e intensidad, sin mecanizar, se instala en superficie

EJEMPLO ELECCIÓN DE INTERIORES

El cliente desea añadir una cajonera a un cuerpo del armario de 180 cm, de 239 cm de altura

Buscar la cajonera deseada, dentro del intervalo, en este ejemplo elegimos la **CG3318** de 3 cajones y su color.

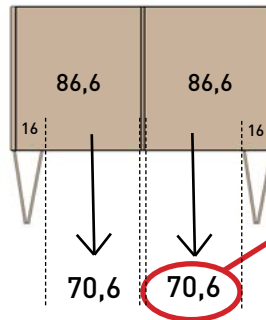

Las medidas interiores del armario son de 96,6 cm. Para elegir la cajonera debemos restar el espacio de las puertas (16) para poder abrir los cajones.

de 60,1 a 80



Ref.	Puntos
CG3318	247





Que características tienen la cajonera y que puntos quedan

Tenemos la cajonera **CG3318** con tres cajones encajando perfectamente al espacio, color Arena.

No hay incremento en los puntos por recortar la cajonera, son **247 puntos**.

En resumen:
Solo se tiene que elegir **CG3318** de 70,6 cm color Arena para el segundo cuerpo del armario.

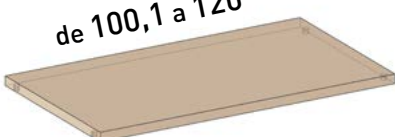

ESTANTES FONDO 55

Grosor 3	hasta 40	de 40,1 a 50	de 50,1 a 60	de 60,1 a 80
				
Ref.	ET84	ET85	ET86	ET88
Puntos	22	25	29	32

Grosor 3	de 80,1 a 100	de 100,1 a 120
		
Ref.	ET80	ET82
Puntos	34	39

ESTANTES EXTRAIBLES FONDO 55

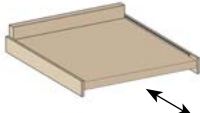
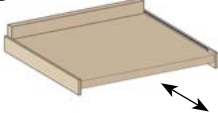



16

Grosor 3	hasta 40	de 40,1 a 50	de 50,1 a 60	de 60,1 a 80
				
Ref.	ETT84	ETT85	ETT86	ETT88
Puntos	54	57	61	64

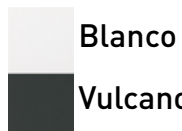

BARRAS

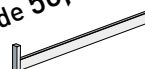
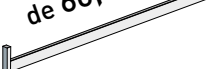

Ref.	hasta 40	de 40,1 a 50	de 50,1 a 60	de 60,1 a 80	de 80,1 a 100	de 100,1 a 120
						
Puntos	16	19	22	25	28	35

Incorpora 3 soportes.

ESTANTES CRISTAL FONDO 55

Grosor 0.6

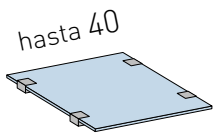

hasta 40

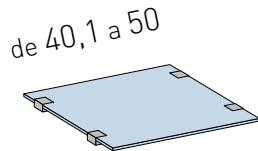

de 40,1 a 50

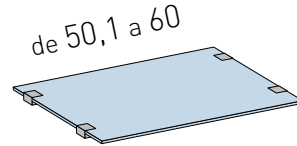

de 50,1 a 60

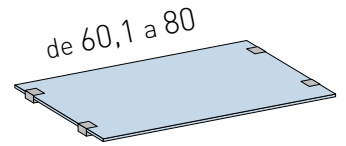

de 60,1 a 80

Ref.	EV43	EV53	EV63	EV83
Puntos	54	62	70	87

Grosor 0.6

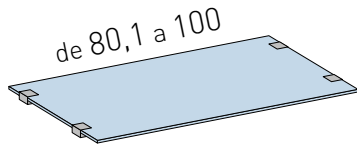

de 80,1 a 100

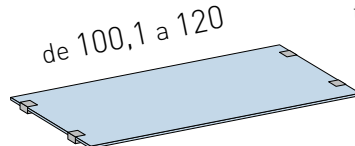

de 100,1 a 120

Acabados cristal transparente y opaco

Acabados soporte estante cristal



Ref.	EV103	EV123
Puntos	114	130

BARRA Y ESTANTE CURVO

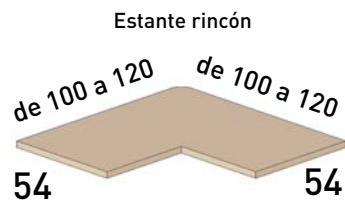

Estante rincón

de 100 a 120 de 100 a 120
54 54

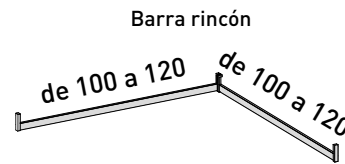

Barra rincón

de 100 a 120 de 100 a 120

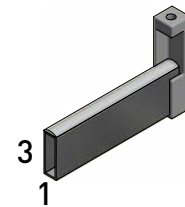

Barra rectangular con 2 soportes de fijación a costado o estante. Perfil superior minimiza ruido.

Blanco
Vulcano

Ref.	ER54	BN
Puntos	96	50

ZAPATERO FIJO FONDO 55

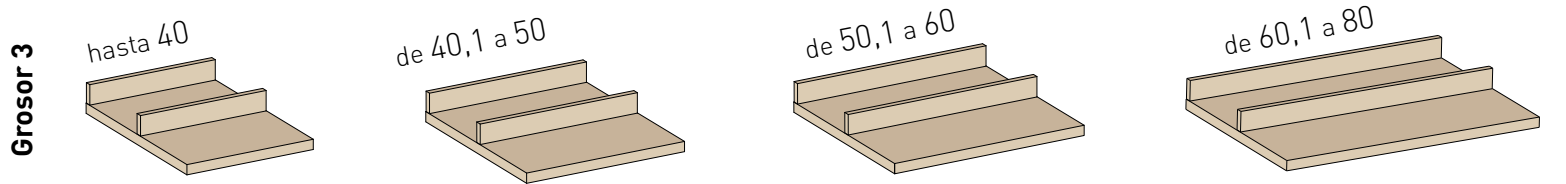

Ref.	EZ43	EZ53	EZ63	EZ83
Puntos	34	38	43	47

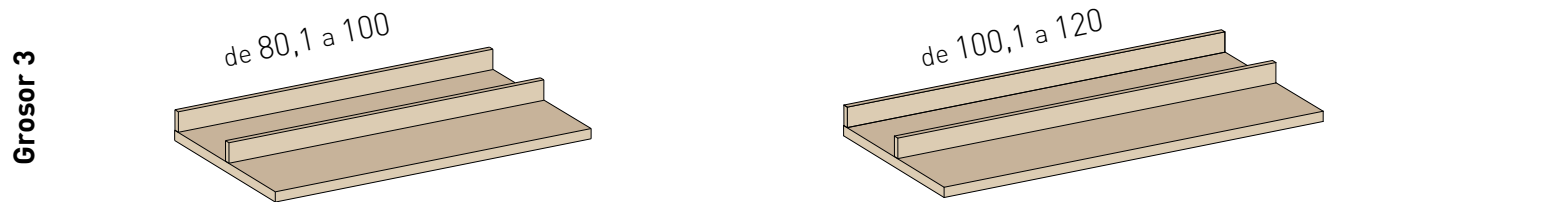

Ref.	EZ103	EZ123
Puntos	50	56

ZAPATERO EXTRAÍBLE FONDO 55

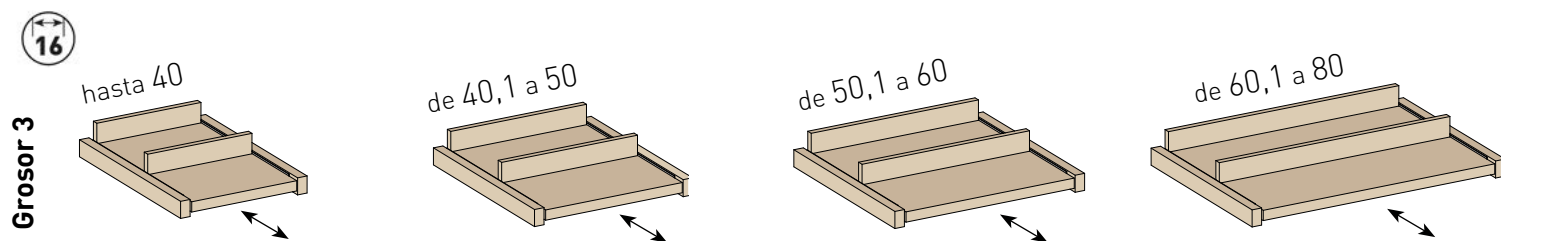

Ref.	EX43	EX53	EX63	EX83
Puntos	59	63	68	73

ZAPATERO INCLINADO FONDO 55

* Medidas especiales de fondo consultar con fábrica



Ref.	EN43	EN53	EN63	EN83
Puntos	40	44	49	53

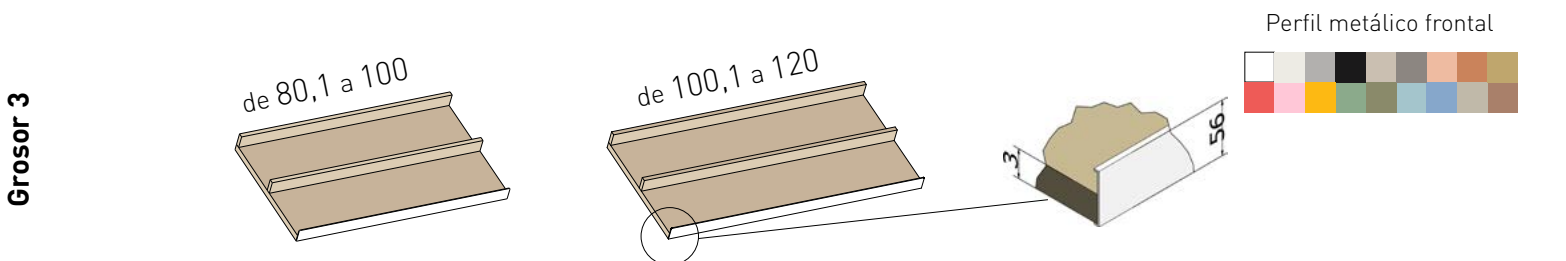

Ref.	EN103	EN123
Puntos	56	62

PARTIDORES FONDO 55

Grosor 3

hasta 100



de 100,1 a 150



de 150,1 a 200



desde 200,1



Ref.	DNT103	DNT153	DNT203	DNT303
Puntos	49	54	58	64

OPCIONES

Zapatero extensible y extraíble

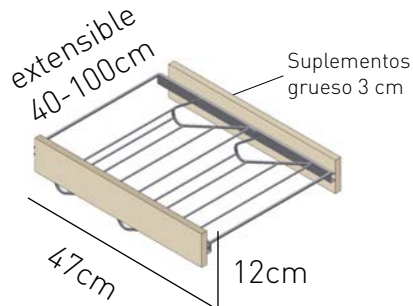

Barra abatible y extensible



Mesa planchar plegable



Ref.	ZPR	BRT	TPL
Puntos	100	110	168

LEDS

*Sensor movimiento incorporado

1 tira de led



2 tiras de leds



Ref.	LED10	LED20
Puntos	168	288



Altura 21,5

hasta 40



Ref. **CG1314**

Puntos **91**

de 40 a 60



Ref. **CG1316**

Puntos **107**

de 60,1 a 80



Ref. **CG1318**

Puntos **127**

de 80,1 a 100



Ref. **CG1310**

Puntos **144**

Altura 37

hasta 40



Ref. **CG2314**

Puntos **141**

de 40 a 60



Ref. **CG2316**

Puntos **159**

de 60,1 a 80



Ref. **CG2318**

Puntos **187**

de 80,1 a 100



Ref. **CG2310**

Puntos **210**

Altura 52,5

hasta 40



Ref. **CG3314**

Puntos **191**

de 40 a 60



Ref. **CG3316**

Puntos **211**

de 60,1 a 80



Ref. **CG3318**

Puntos **247**

de 80,1 a 100



Ref. **CG3310**

Puntos **276**

Altura 68

hasta 40



Ref. **CG4314**

Puntos **241**

de 40 a 60



Ref. **CG4316**

Puntos **263**

de 60,1 a 80



Ref. **CG4318**

Puntos **307**

de 80,1 a 100



Ref. **CG4310**

Puntos **342**

Altura 83,5

hasta 40



Ref. **CG5314**

Puntos **291**

de 40 a 60



Ref. **CG5316**

Puntos **315**

de 60,1 a 80



Ref. **CG5318**

Puntos **367**

de 80,1 a 100



Ref. **CG5310**

Puntos **408**

Altura 99

hasta 40



Ref. **CG6314**

Puntos **341**

de 40 a 60



Ref. **CG6316**

Puntos **367**

de 60,1 a 80



Ref. **CG6318**

Puntos **427**

de 80,1 a 100



Ref. **CG6310**

Puntos **476**

CAJONERAS FONDO 55



Altura 26,5

hasta 40



de 40 a 60



de 60,1 a 80



de 80,1 a 100



Ref.	CG1364	CG1366	CG1368	CG1360
Puntos	96	111	131	148

Altura 47

hasta 40



de 40 a 60



de 60,1 a 80



de 80,1 a 100



Ref.	CG2364	CG2366	CG2368	CG2360
Puntos	146	167	195	218

Altura 67,5

hasta 40



de 40 a 60



de 60,1 a 80



de 80,1 a 100



Ref.	CG3364	CG3366	CG3368	CG3360
Puntos	201	223	259	288

Altura 88

hasta 40



de 40 a 60



de 60,1 a 80



de 80,1 a 100



Ref.	CG4364	CG4366	CG4368	CG4360
Puntos	254	279	323	358

Altura 108,5

hasta 40



de 40 a 60



de 60,1 a 80











de 80,1 a 100





Ref.	CG5364	CG5366	CG5368	CG5360
Puntos	307	335	387	428

CAJONERAS PARA COLGAR FONDO 55

<p>16</p> <p>Altura 18,5</p>	<p>COSTILLA 11</p> <p>hasta 60  de 60,1 a 80 </p>		<p>COSTILLA 16</p> <p>hasta 60  de 60,1 a 80 </p>	
	<p>CG156C</p> <p>87</p>	<p>CG158C</p> <p>101</p>	<p>CG166C</p> <p>90</p>	<p>CG168C</p> <p>104</p>
<p>Altura 34</p>	<p>hasta 60  de 60,1 a 80 </p>		<p>Altura 44</p> <p>hasta 60  de 60,1 a 80 </p>	
	<p>CG256C</p> <p>137</p>	<p>CG258C</p> <p>158</p>	<p>CG266C</p> <p>143</p>	<p>CG268C</p> <p>164</p>

SEPARADORES PARA CAJONES

<p>16</p> <p>Altura 18,5</p>	<p>Incremento por separadores (Cajón no incluido)</p> <p>hasta 60  de 60,1 a 80 </p>	
	<p>Ref. CRB685</p> <p>Puntos 30</p>	<p>Ref. CRB105</p> <p>Puntos 34</p>

CASILLERO FONDO 55

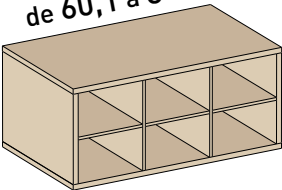
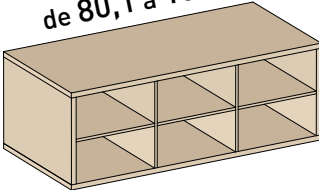
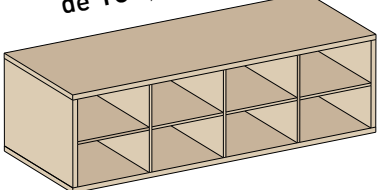
<p>Altura 36</p>	<p>de 60,1 a 80 </p>	<p>de 80,1 a 100 </p>	<p>de 100,1 a 120 </p>
	<p>Ref. CS82</p> <p>Puntos 90</p>	<p>Ref. CS102</p> <p>Puntos 114</p>	<p>Ref. CS122</p> <p>Puntos 148</p>

PANTALONEROS FONDO 55

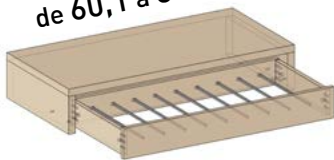
<p>16</p> <p>Altura 18,5</p>	<p>hasta 60 </p>	<p>de 60,1 a 80 </p>
	<p>Ref. PNT606</p> <p>Puntos 150</p>	<p>Ref. PNT686</p> <p>Puntos 164</p>



Disponibles cajones de 11, 16 y 22 cm de alto en costilla.

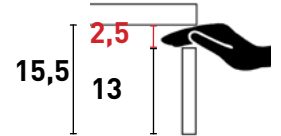

Altura Costilla	Ancho total de 40 a 60	Altura Total	Ref.	Puntos
11		15,5	CGN316	52
16		20,5	CGN366	56
22		29,5	CGN356	69

Altura Costilla	Ancho total de 60,1 a 80	Altura Total	Ref.	Puntos
11		15,5	CGN318	60
16		20,5	CGN368	64
22		29,5	CGN358	77

El precio de los lados de la cajonera va incluido en cada cajón.

Ancho total de 40 a 60	Ref.	Puntos
Tapa y base	CFN348	55

Ancho total de 60,1 a 80	Ref.	Puntos
Tapa y base	CFN368	67

Seleccionar altura y cantidad de cajones + una tapa (obligatoria), todos del mismo ancho.
Con estas referencias ya podemos crear la cajonera de libre composición.

Ejemplo de cajonera de 40 a 60:

11		CGN316	52	+		=		3	Altura Tapa
16		CGN366	56					15,5	Altura Costilla 11
16		CGN366	56					20,5	Altura Costilla 16
16		CGN366	56					20,5	Altura Costilla 16
22		CGN356	69					29,5	Altura Costilla 22
								3	Altura Tapa
								Puntos Total	
								(52 + 56 + 56 + 69) + 55	
								288	
								Altura Total	
								(3 + 15,5 + 20,5 + 20,5 + 29,5 + 3)	
								92	

ESTRUCTURA

Cajón frente cristal

Costillas laterales acabado único ANTRACITA

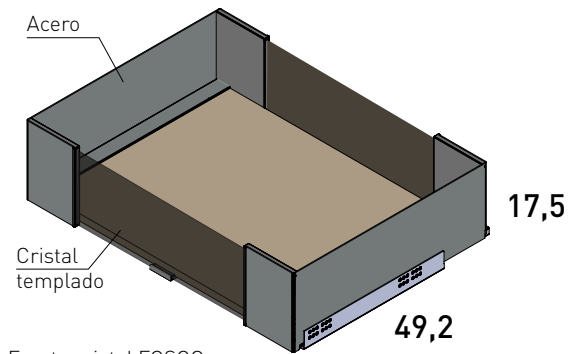

Frente cristal FOSCO

Acabados laminados base cajón

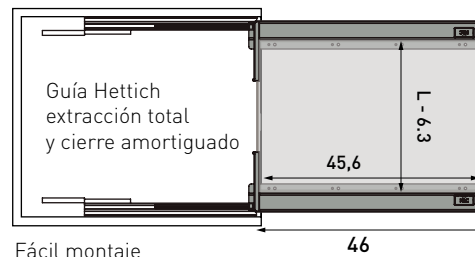
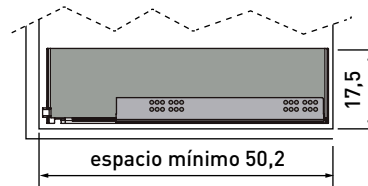

Fácil montaje
Espaciador para salvar bisagras incorporado

L hueco armario	Ref.	Puntos
40-50	CF140	171
50-60	CF150	177
60-70	CF160	180
70-80	CF170	191
80-90	CF180	198
90-100	CF190	204
100-110	CF100	211
110-116	CF110	218

Cajón frente cristal

Costillas laterales acabado único ANTRACITA

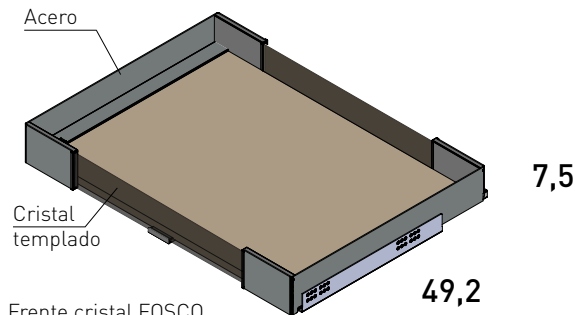

Frente cristal FOSCO

Acabados laminados base cajón

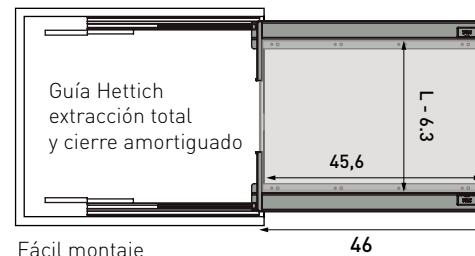
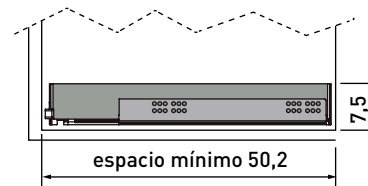

Fácil montaje
Espaciador para salvar bisagras incorporado

L hueco armario	Ref.	Puntos
40-50	CF740	158
50-60	CF750	162
60-70	CF760	166
70-80	CF770	173
80-90	CF780	179
90-100	CF790	186
100-110	CF700	193
110-116	CF711	201

COMPLEMENTOS

Joyero organizador

Acabado TITANIO

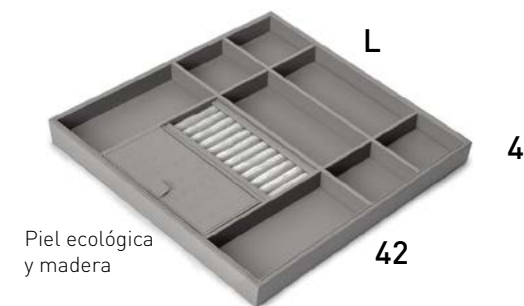

Piel ecológica y madera

L	Ref.	Puntos
44	JR4	88
54	JR5	100
64	JR6	112
74	JR7	124

Caja accesorios

Acabado único ANTRACITA
Acero

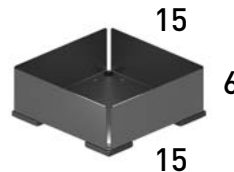

L	Ref.	Puntos
15	CAJ15	24

Bandeja accesorios

Acabado único ANTRACITA
Acero



L	Ref.	Puntos
28	BAN28	28
45	BAN45	30

ESTRUCTURA

Cajón zapatero frente cristal

Costillas laterales acabado único ANTRACITA

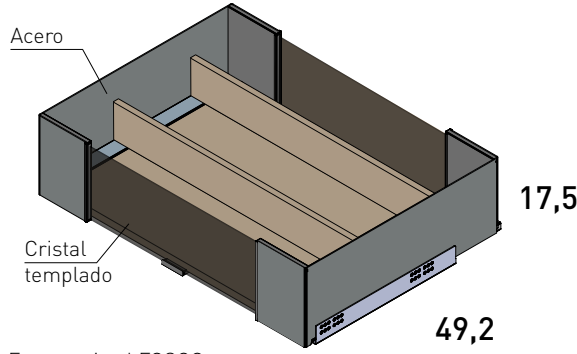

Frente cristal FOSCO

Acabados laminados base cajón

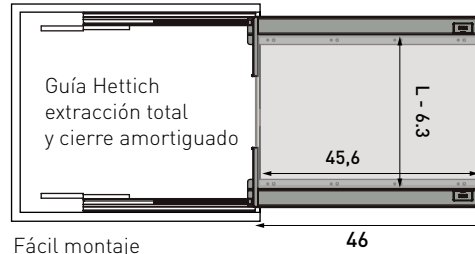
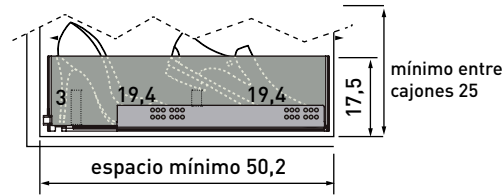

Fácil montaje
Espaciador para salvar bisagras incorporado

L hueco armario	Ref.	Puntos
40-50	CZ40	184
50-60	CZ50	191
60-70	CZ60	199
70-80	CZ70	210
80-90	CZ80	219
90-100	CZ90	226
100-110	CZ10	235
110-116	CZ11	242

COLGADORES

Perchero Abatible

Acabado único ANTRACITA
Acero

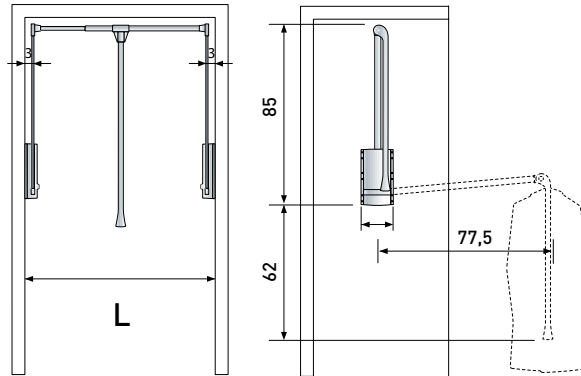
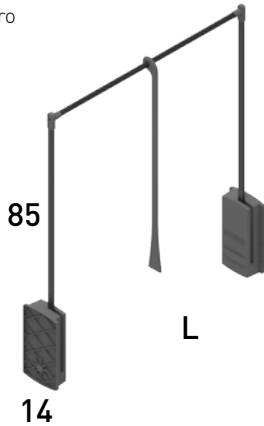

L hueco armario	Ref.	Puntos
44-60	PER4	114
60-90	PER6	130
90-116	PER7	134

Perchero extraíble SUPERIOR

Acabado único ANTRACITA
Acero

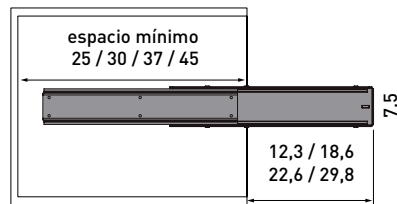
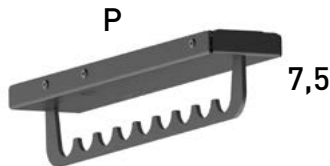

Carga máxima 15kg
Necesita estante superior

P	Ref.	Puntos
24	PEX24	44
29	PEX29	46
36	PEX36	48
44	PEX44	50

Barras colgar

Acabado ANTRACITA
Aluminio

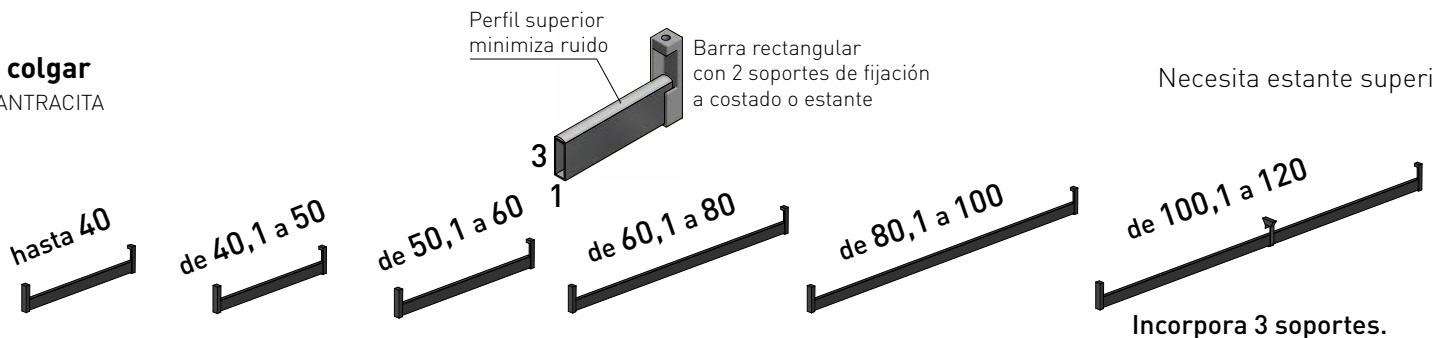

Ref.	BL40	BL50	BL60	BL80	BL10	BL12
Puntos	18	21	25	27	30	38

ACCESORIOS

Zapatero lateral extraíble

Acabado único ANTRACITA
Acero

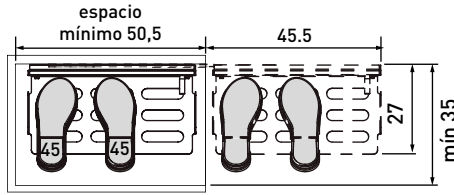
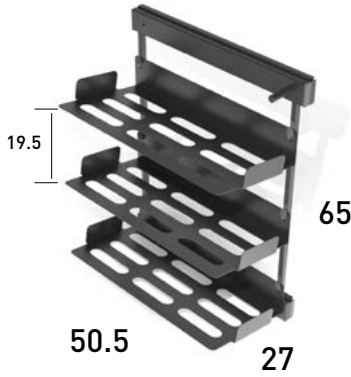

Espaciador para salvar bisagras incorporado

L	Ref.	Puntos
DR	Z65D	196
IZ	Z65Z	196

Cesta de tela

Estructura ANTRACITA
Acero / Tela gris

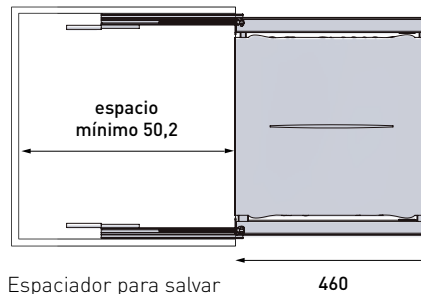

Espaciador para salvar bisagras incorporado

L	Ref.	Puntos
53,5-58,5	CET5	226
58,5-63,5	CET6	234

Corbatero lateral extraíble

Acabado único ANTRACITA
Acero

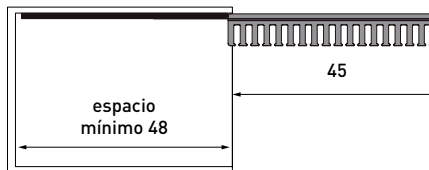
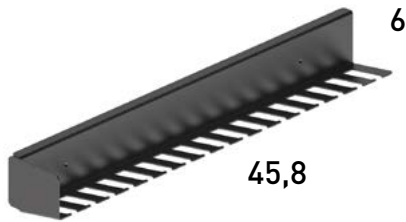

Espaciador para salvar bisagras incorporado

L	Ref.	Puntos
DR	CORD	65
IZ	CORZ	65

Espejo lateral extraíble

Acabado único GRAFITO

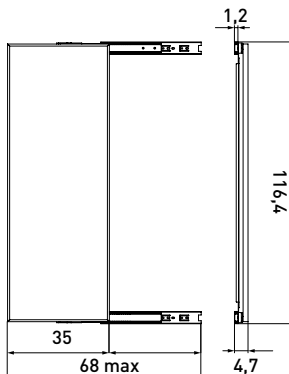
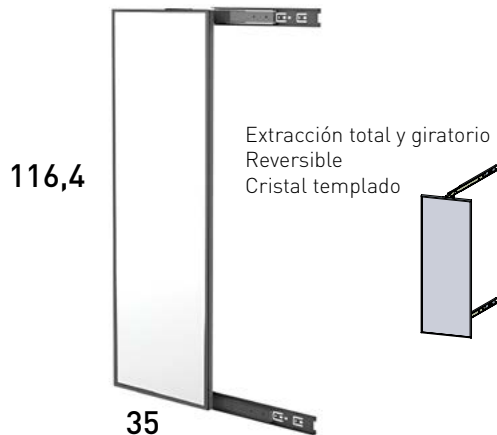

Espaciador para salvar bisagras incorporado

L	Ref.	Puntos
35	ESPEX	90

Guía Hettich extracción total y cierre amortiguado
Soportes con funda antideslizante

PANTALONEROS

Bandeja pantalonero

Acabado único ANTRACITA
Acero



Carga máxima 30kg

49

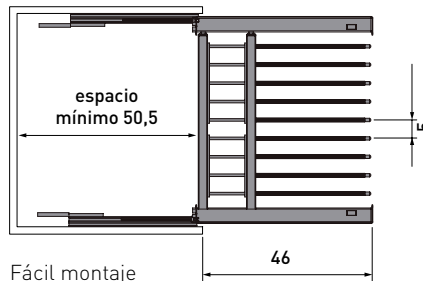

Fácil montaje
Espaciador para salvar
bisagras incorporado

Soportes	L	Ref.	Puntos
7-9	50,5-60,5	PAX60	204
9-11	60,5-70,5	PAX70	209
11-13	70,5-80,5	PAX80	219
13-15	80,5-90,5	PAX90	227

Bandeja accesorios

Acabado único ANTRACITA



* Bandejas recomendadas según medida
de 50,5 a 65,5 cm 1 unidad
de 65,5 a 85,5 cm 2 unidades
de 85,5 a 90,5 cm 3 unidades

Ref.	Puntos
BDA24	14

Pantalonero extraíble LATERAL

Acabado único ANTRACITA
Acero

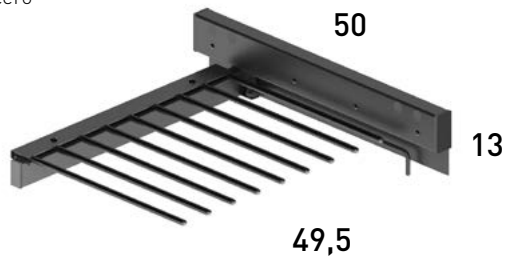

Reversible
Para 9 pantalones

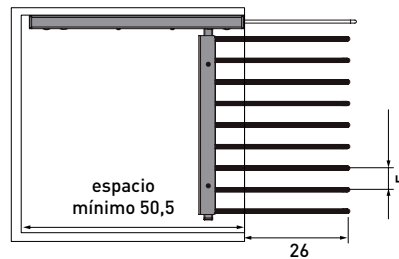

Espaciador para salvar
bisagras incorporado

Ref.	Puntos
PAXL	133

Pantalonero extraíble SUPERIOR

Acabado único ANTRACITA
Acero

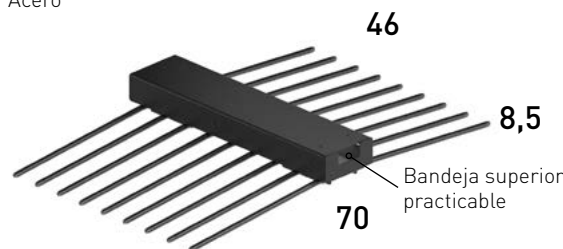

Para 18 pantalones.
Necesita estante superior

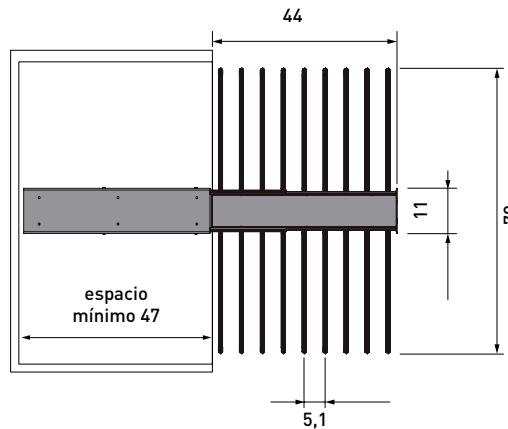

Ref.	Puntos
PAX18	148

Pantalonero extraíble SUPERIOR

Acabado único ANTRACITA
Acero

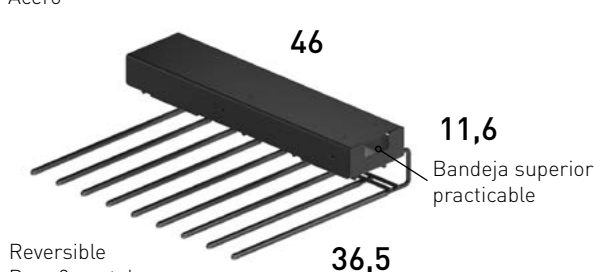

Reversible
Para 9 pantalones
Necesita estante superior

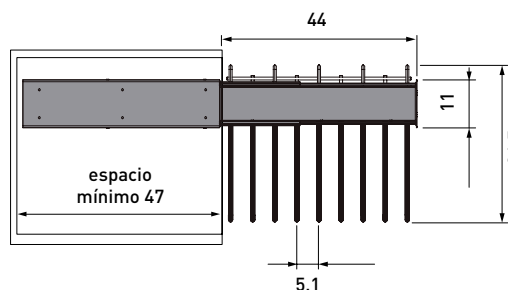

Ref.	Puntos
PAX9	112



Estructuras para interiores de armario
(Interiores no regulables en altura)



Columnas aluminio

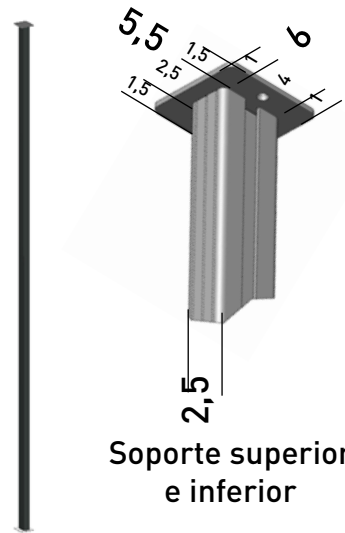

Altura	Ref.	Puntos
150 - 200	CAL1	86
201 - 274	CAL2	96

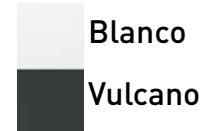

Estos estantes no tienen mano.



ESTANTES FONDO 55

Grueso 3

hasta 40



1 soporte incluido + 2 soportes UX

ET94

37

de 40,1 a 50



1 soporte incluido + 2 soportes UX

ET95

40

de 50,1 a 60



1 soporte incluido + 2 soportes UX

ET96

44

Grueso 3

de 60,1 a 80



1 soporte incluido + 2 soportes UX

ET98

47

de 80,1 a 100

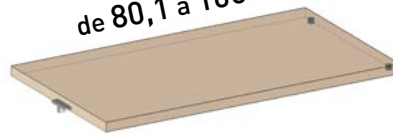

1 soporte incluido + 2 soportes UX

ET90

49



ESTANTES EXTRAIBLE FONDO 55

16

Grosor 3

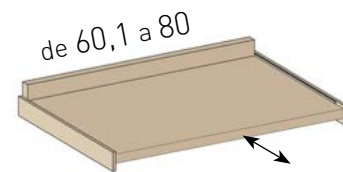
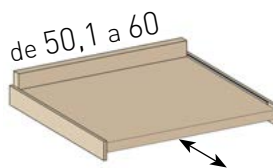
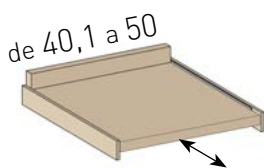

No tiene mano
Soportes incluidos

Ref.	ETX44	ETX54	ETX64	ETX84
Puntos	69	72	76	79

ESTANTES CRISTAL FONDO 55

Grosor 0.6

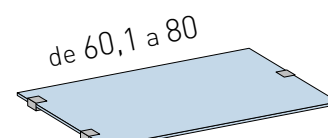
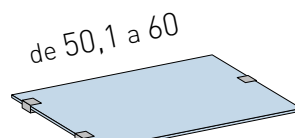
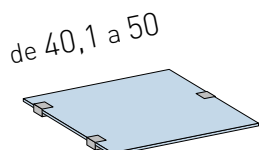
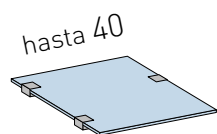

No tiene mano
Soportes incluidos

Ref.	EV44	EV54	EV64	EV84
Puntos	66	74	82	99

Grosor 0.6

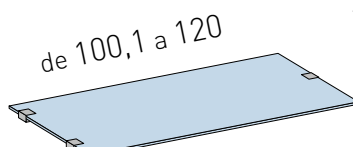
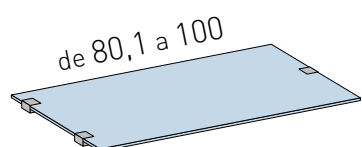

Acabados cristal
transparente y opaco

Acabados soporte
estante cristal



Ref.	EV104	EV124
Puntos	126	142

ZAPATERO FIJO FONDO 55

Grosor 3

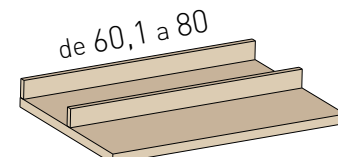
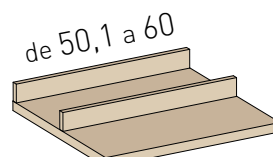
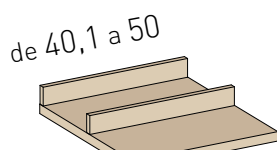
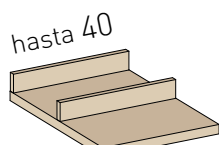

Soportes incluidos

Ref.	EZ44Z	EZ44D	EZ54Z	EZ54D	EZ64Z	EZ64D	EZ84Z	EZ84D
Puntos	49	49	53	53	57	57	62	62

Grosor 3

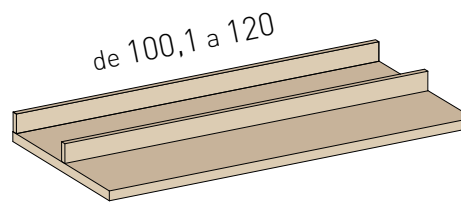
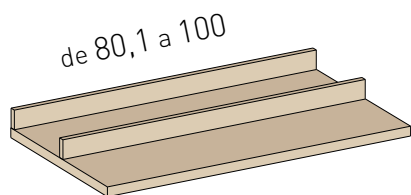

Ref.	EZ104Z	EZ104D	EZ124Z	EZ124D
Puntos	65	65	71	71



ZAPATERO EXTRAÍBLE FONDO 55



No tiene mano
Soportes incluidos

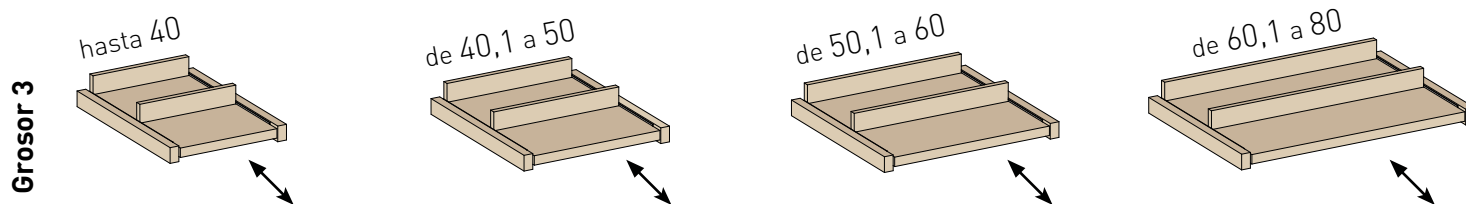

Ref.	EX44	EX54	EX64	EX84
Puntos	71	75	80	84

BARRAS

No tiene mano
Soportes incluidos

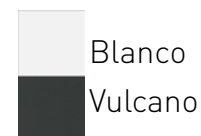
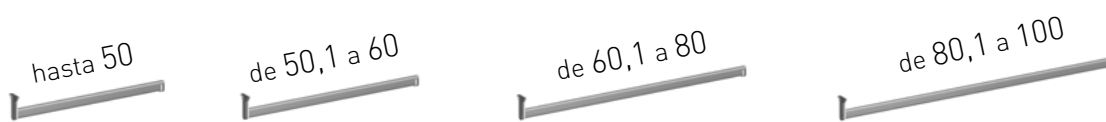

Cada barra incorpora un juego de dos soportes.

Ref.	BC45	BC56	BC68	BC100
Puntos	27	30	33	41

CAJONERAS FONDO 55



Para cajón separador pag 116.

Costilla de 11

No tienen mano
Soportes incluidos

Altura 21,5



Ref.	CG163	CG183
Puntos	114	134

Altura 37

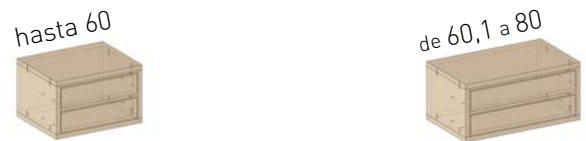

Ref.	CG263	CG283
Puntos	166	195

PANTALONEROS FONDO 55



No tiene mano
Soportes incluidos

Altura 18,5

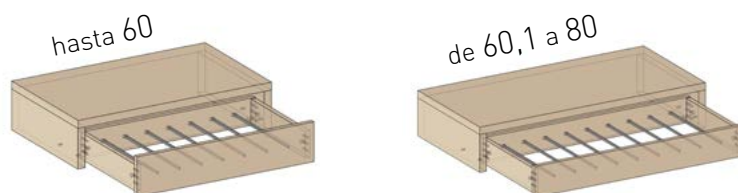

Ref.	PNT607	PNT687
Puntos	162	174

OPCIONES RAIL SYSTEM

EJEMPLO ELECCIÓN DE INTERIORES

Añade una referencia de sistema de guías **por cada hueco** que desees equipar con **Rail System**

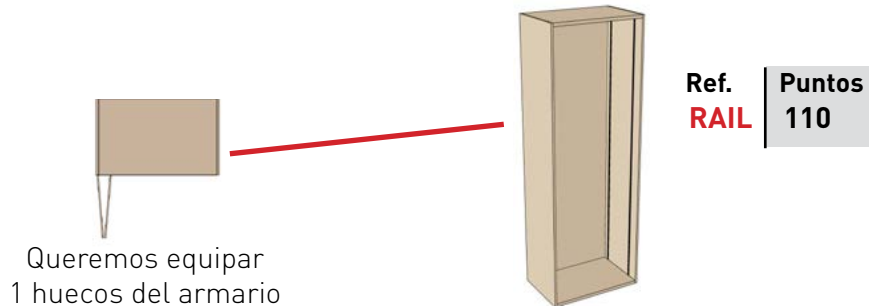

Deseamos añadir 2 estantes, una barra de colgar y una cajonera al interior de un armario de 95 cm, de 239 cm de altura.

Buscar las opciones de interior deseadas para un hueco interior de 91,2.

Al modificar el armario de 100 a 95 las medidas de hueco son 91,2.

Ref.	Puntos
ET80R	48
ET80R	48
BC10R	30
CG2410R	240

No hay incremento en los puntos por recortar las opciones, son 110 puntos por Rail System 1 hueco + 366 puntos por interiores un total de **476 puntos**

Las opciones de interior se adaptan a la medida exacta del hueco interior.

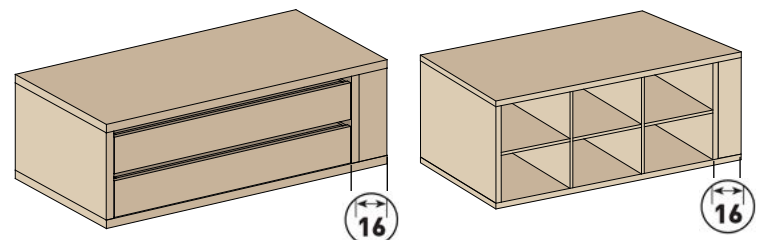

Cajoneras y casilleros Rail System cuentan con un fijo de para salvar la puerta

OPCIONES PARA ARMARIOS PLEGABLES CON RAIL SYSTEM

RAIL SYSTEM



* Incluir una referencia por cuerpo

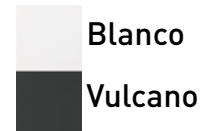

Ref.	RAIL
Puntos	110

ESTANTES FONDO 55

Grosor 3

hasta 40



de 40,1 a 50



de 50,1 a 60



de 60,1 a 80



Ref.	ET84R	ET85R	ET86R	ET88R
Puntos	36	39	43	46

Grosor 3

de 80,1 a 100

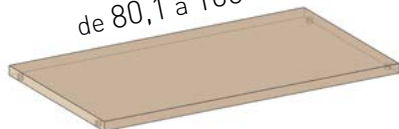

de 100,1 a 120

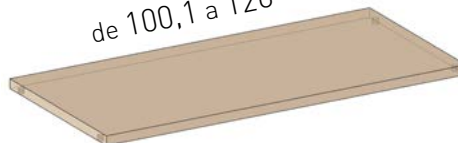

* Incluye 4 soportes

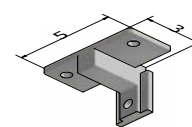
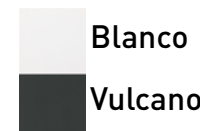

Ref.	ET80R	ET82R
Puntos	48	53

ESTANTES EXTRAIBLES FONDO 55

16

Grosor 3

hasta 40



de 40,1 a 50

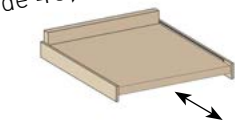

de 50,1 a 60

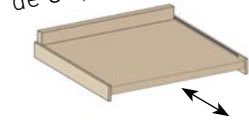

de 60,1 a 80



Ref.	ETT84R	ETT85R	ETT86R	ETT88R
Puntos	68	71	75	79

Grosor 3

de 80,1 a 100

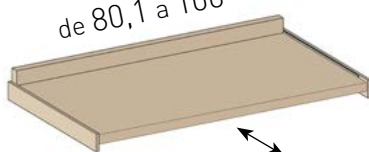

de 100,1 a 120

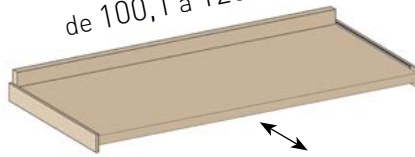

* Incluye 4 soportes

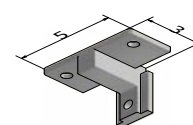
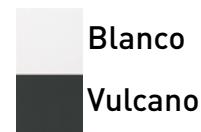

Ref.	ETT80R	ETT82R
Puntos	80	85

BARRAS

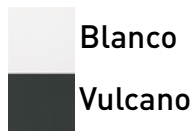

* Obligatorio un estante superior

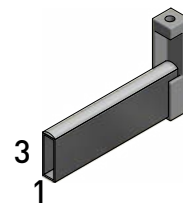

Barra rectangular con 2 soportes de fijación a estante. Perfil superior minimiza ruido.

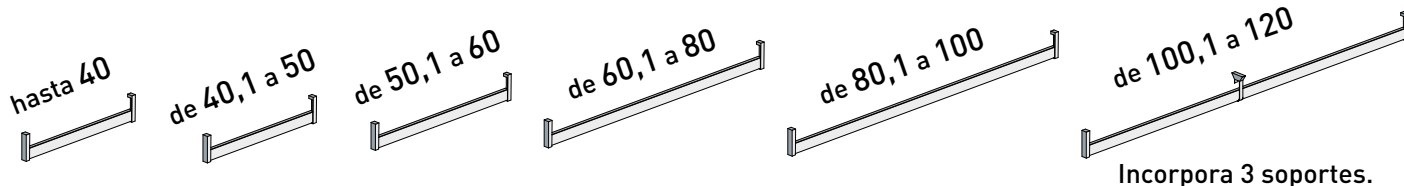

Ref.	BC4R	BC5R	BC6R	BC8R	BC10R	BC12R
Puntos	18	21	24	27	30	37

ESTANTES CRISTAL FONDO 55

Grosor 0,6

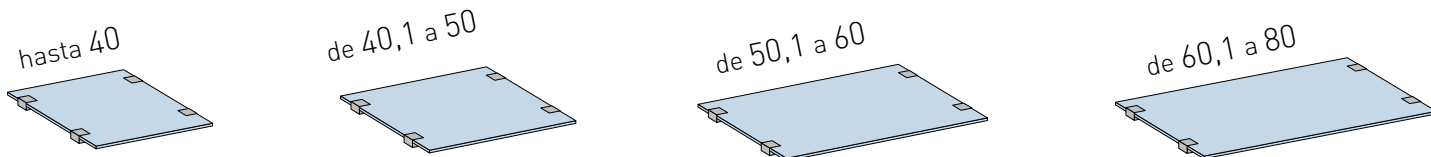

Ref.	EV43R	EV53R	EV63R	EV83R
Puntos	76	84	92	108

Grosor 0,6

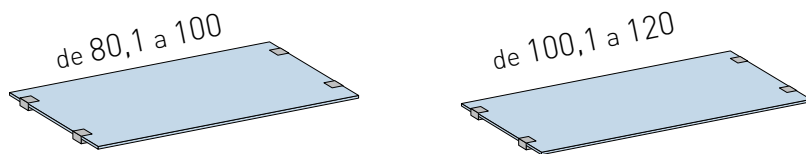

Acabados cristal transparente y opaco

Acabados soporte estante cristal



Ref.	EV103R	EV123R
Puntos	126	152

BARRA Y ESTANTE CURVO

* Obligatorio un estante superior

* Incluye 5 soportes

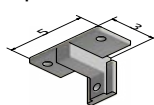
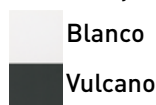
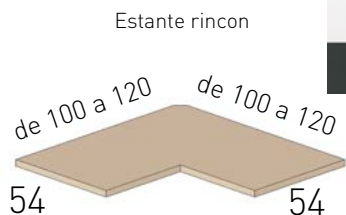

Barra rincón



Barra rectangular con 2 soportes de fijación a estante. Perfil superior minimiza ruido.

Ref.	ER54R	BNR
Puntos	116	53

OPCIONES PARA ARMARIOS PLEGABLES CON RAIL SYSTEM

ZAPATERO FIJO FONDO 55

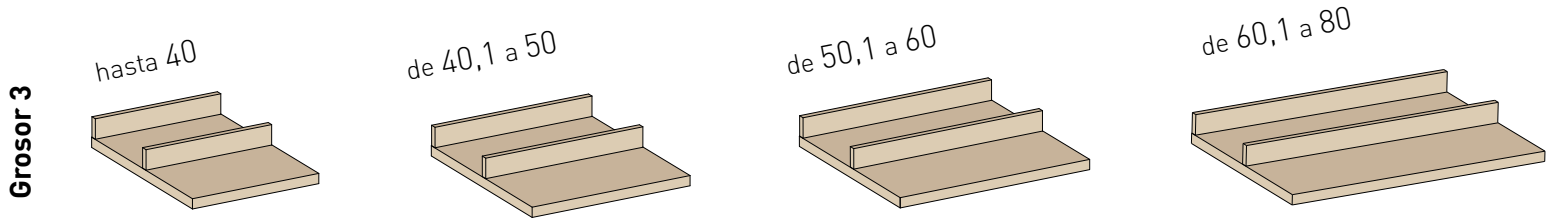

Ref.	EZ43R	EZ53R	EZ63R	EZ83R
Puntos	48	52	57	61

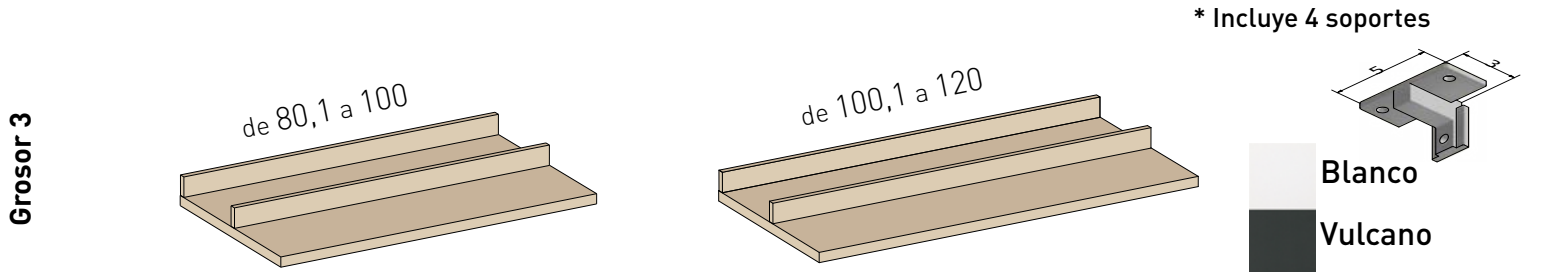

Ref.	EZ103R	EZ123R
Puntos	64	70

ZAPATERO EXTRAÍBLE FONDO 55

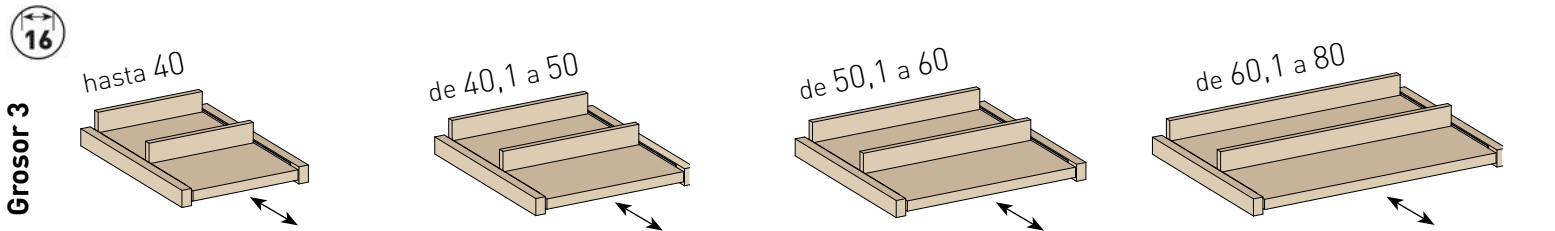

Ref.	EX43R	EX53R	EX63R	EX83R
Puntos	73	77	82	86

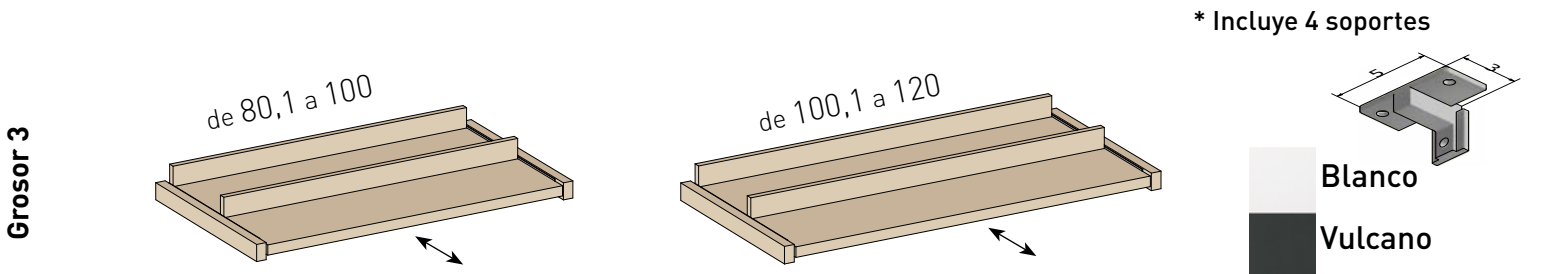

Ref.	EX103R	EX123R
Puntos	89	95

PARTIDORES FONDO 55

Grosor 3

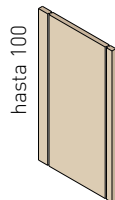

hasta 100

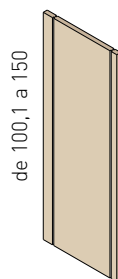

de 100,1 a 150



de 150,1 a 200



desde 200,1

*Por defecto incluye Rail System por ambos lados.

Ref.	DNT103R	DNT153R	DNT203R	DNT303R
Puntos	94	124	163	174

PARTIDORES ALUMINIO

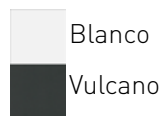

* Compatible solo con cajoneras colgadas

Grosor 3

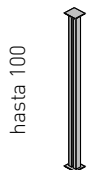

hasta 100



de 100,1 a 150



de 150,1 a 200



desde 200,1

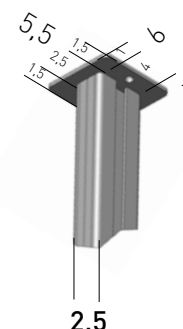

Soporte superior e inferior

Ref.	CAL10	CAL15	CAL20	CAL30
Puntos	46	52	86	96

OPCIONES

16

Zapatero extensible y extraíble

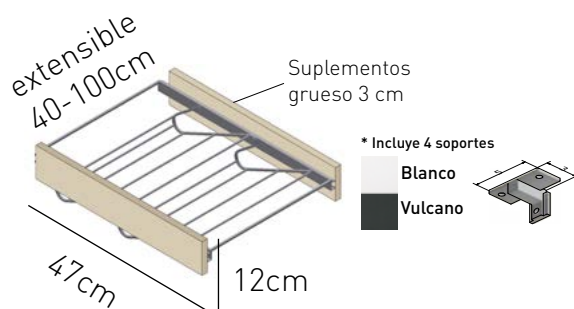

Barra abatible y extensible

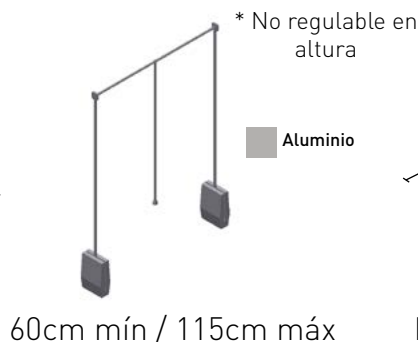

Mesa planchar plegable



Ref.	ZPR3	BRT	TPL
Puntos	105	110	168

LEDS

1 tira de led



2 tiras de leds



Ref.	LED10	LED20
Puntos	168	288

CAJONERAS FONDO 47,5



Altura 21,5

COSTILLA 11

hasta 40 de 40 a 60 de 60,1 a 80 de 80,1 a 100 de 100,1 a 120

Ref.	CG1414R	CG1416R	CG1418R	CG1410R	CG1412R
Puntos	121	137	157	174	192

Altura 37

hasta 40 de 40 a 60 de 60,1 a 80 de 80,1 a 100 de 100,1 a 120

Ref.	CG2414R	CG2416R	CG2418R	CG2410R	CG2412R
Puntos	171	189	217	240	264

Altura 52,5

hasta 40 de 40 a 60 de 60,1 a 80 de 80,1 a 100 de 100,1 a 120

Ref.	CG3414R	CG3416R	CG3418R	CG3410R	CG3412R
Puntos	221	241	277	306	336

Altura 68

hasta 40 de 40 a 60 de 60,1 a 80 de 80,1 a 100 de 100,1 a 120

Ref.	CG4414R	CG4416R	CG4418R	CG4410R	CG4412R
Puntos	271	293	337	372	407

* Incluye 4 soportes
Blanco
Vulcano

PANTALONEROS FONDO 55

Altura 18,5

16

hasta 60 de 60,1 a 80 de 80,1 a 100

Ref.	PNT606R	PNT686R	PNT106R
Puntos	174	188	204

* Incluye 4 soportes
Blanco
Vulcano



No tiene mano

CAJONERAS FONDO 47,5

COSTILLA 16

Altura 26,5

hasta 40



de 40 a 60

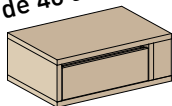

de 60,1 a 80



de 80,1 a 100

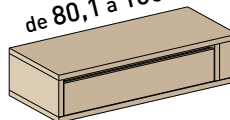

de 100,1 a 120

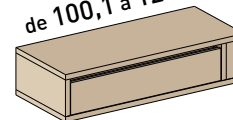

Ref.	CG1464R	CG1466R	CG1468R	CG1460R	CG1462R
Puntos	126	141	161	178	196

Altura 47

hasta 40



de 40 a 60

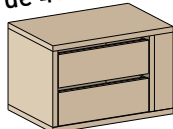

de 60,1 a 80

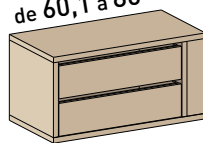

de 80,1 a 100

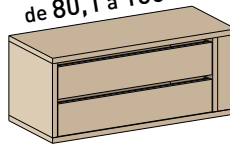

de 100,1 a 120

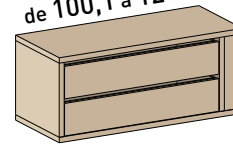

Ref.	CG2464R	CG2466R	CG2468R	CG2460R	CG2462R
Puntos	176	197	225	248	272

Altura 67,5

hasta 40

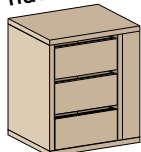

de 40 a 60



de 60,1 a 80

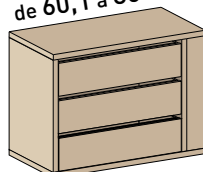

de 80,1 a 100

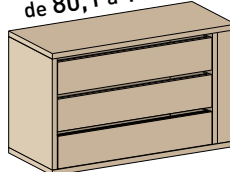

de 100,1 a 120

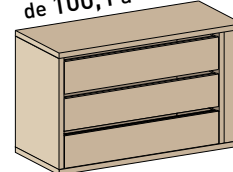

* Incluye 4 soportes
Blanco
Vulcano

Ref.	CG3464R	CG3466R	CG3468R	CG3460R	CG3462R
Puntos	231	253	286	318	398

SEPARADORES

Altura 18,5

hasta 60



de 60,1 a 80



de 80,1 a 100



de 100,1 a 120



Incremento por separadores (Cajón no incluido)

Ref.	CRB603	CRB683	CRB103	CRB123
Puntos	24	30	34	42



No tiene mano

CASILLERO FONDO 47,5

Altura 36

de 60,1 a 80

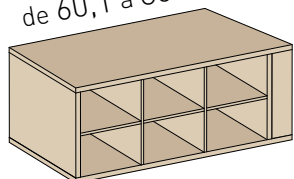

de 80,1 a 100

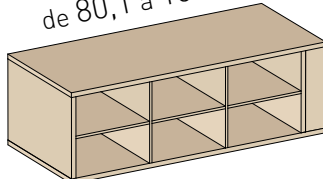

de 100,1 a 120

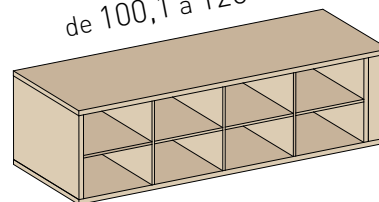

* Incluye 4 soportes

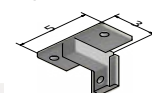

Blanco

Vulcano

Ref.	NPC8	NPC10	NPC12
Puntos	120	144	180

Disponibles cajones de 11 y 16 cm de alto en costilla.

Ancho total de 40 a 60		Ancho total de 60,1 a 80		Ancho total de 80,1 a 100	
Altura Costilla	Altura Total	Altura Costilla	Altura Total	Altura Costilla	Altura Total
11	15,5	11	15,5	11	15,5
Ref.	CGN416R	Ref.	CGN418R	Ref.	CGN410R
Puntos	50	Puntos	57	Puntos	62
16	20,5	16	20,5	16	20,5
Ref.	CGN466R	Ref.	CGN468R	Ref.	CGN460R
Puntos	53	Puntos	60	Puntos	65

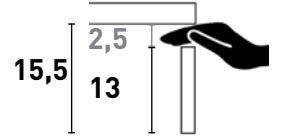

El precio de los lados de la cajonera va incluido en cada cajón.

* Incluye 4 soportes

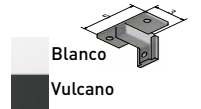

Ancho total de 40 a 60		Ancho total de 60,1 a 80		Ancho total de 80,1 a 100	
Ref.	Puntos	Ref.	Puntos	Ref.	Puntos
CFN446R	85	CFN468R	98	CFN480R	108
Tapa y base		Tapa y base		Tapa y base	

Seleccionar altura y cantidad de cajones + una tapa (obligatoria), todos del mismo ancho. Con estas referencias ya podemos crear la cajonera de libre composición.

Ejemplo de cajonera de 40 a 60:

11	CFN416R	50			
16	CFN466R	53			
16	CFN466R	53			
+			CFN446R	85	=
					Altura frente + espacio entre cajones 3 Altura Tapa 15,5 Altura Costilla 11 20,5 Altura Costilla 16 20,5 Altura Costilla 16 3 Altura Tapa
				Puntos Total (85 + 53 + 53 + 50) 241	Altura Total (3 + 15,5 + 20,5 + 20,5 + 3) 62,5

TAPETAS

Grosor 1,9

Medidas máximas 282 x 20 cm

Precio metro lineal

Acabado BASE	TAP	Acabado STONE	TAS
	15		17

Acabado BASE	TAP	Acabado STONE	TAS
	15		17

19 L H

Especificar los cantos a chapar. Largos o cortos.

	Acabado BASE		Acabado STONE	
	Ref.	Pts ML	Ref.	Pts ML
sin chapar	8TA	8	8TS	10
1 canto chapado	8TA1	11	8TS1	13
2 cantos chapados	8TA2	14	8TS2	16
3 cantos chapados	8TA3	17	8TS3	19
4 cantos chapados	8TA4	20	8TS4	23

Precio metro lineal

Precio mínimo 1 metro lineal.

FORROS 19

Grosor 1,9

Acabado BASE	FR401	Acabado STONE	FS401
	54		60

Acabado BASE	FR601	Acabado STONE	FS601
	60		66

Acabado BASE	FR801	Acabado STONE	FS801
	66		72

FORROS 10

Grosor 1

Acabado BASE	FR411	Acabado STONE	FS411
	41		45

Acabado BASE	FR611	Acabado STONE	FS611
	47		52

Acabado BASE	FR811	Acabado STONE	FS811
	53		58

INCREMENTO POR COLOR MUESTRA

Por cada color cliente que se aplique hay un mínimo 176 puntos.
En el caso de no llegar al mínimo en el conjunto de piezas del mismo color, se aplicará esta cantidad.

Puertas



Forros



Perfilería



Frente cajón

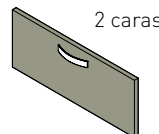

Tirador



Tapeta

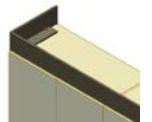

Precio metro lineal.

Ref.	altura	LAC1	altura	LAC2	altura	LAC3	LAC4	LAC5	LAC7
Puntos	120	64	120	42	120	32	15	10	12
	280	88	280	60	280	50	puntos/ud	puntos/ud	puntos/ml

CARACTERÍSTICAS TÉCNICAS ARMARIOS CORREDEROS EXTERIORES

Distribución interior según diseño cliente.

Mantiene integridad superficie con taladros solo donde sean necesarios.

Carro deslizante con sistema de freno amortiguado en apertura total y cierre.

Costados y divisiones canteados en los 4 costados

En algunos casos, a causa de las tensiones de los diferentes materiales que componen las puertas, se colocaran tensores en la parte posterior de la puerta.

Trasera de 10mm con ranura, garantiza mayor estabilidad y firmeza. Facilita el montaje en vertical.

Sistema de fijación de estantes con bloqueo, mejora seguridad y capacidad de carga

Regulador de altura, asegura que el armario este siempre a nivel.

Cajones con sistema de cierre amortiguado

Extracción total y libre configuración de altura de costillas entre 11,16 y 22cm

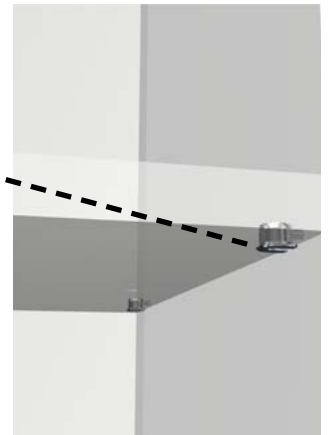
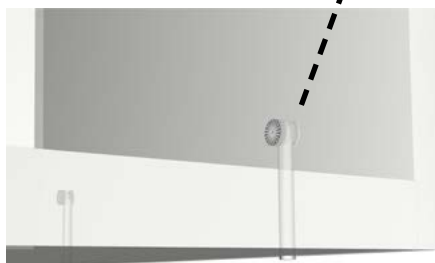

MATERIALES ESTRUCTURA

Costados:	Grueso de 30mm, canteados con PVC de 0.8mm, los 4 costados.
Bucs superior e inferior:	Grueso de 30mm, canteados con PVC de 0.8mm.
Divisiones interiores:	Grueso de 30mm, canteados con PVC de 0.8mm, los 4 costados.
Trasera:	Grueso de 10mm.
Estantes interiores:	Grueso de 30mm, canteados con PVC de 0.8mm, los 4 costados.

COLORES DISPONIBLES

Carta de colores vigente de jotajotape



NUEVOS MATERIALES

Acabados STONE



Acabados STONE solo disponible en grueso 19mm y 10mm. Canteado siempre en PVC 0.8mm. Disponible para frentes, traseras, forros, tapetas y tapas.

Acabados CRISTALES



Cristales con cantos pulidos de 4mm de grosor para puertas y 6mm para estantes. Para los acabados transparente, lacado, translucido y relieves, cristal templado y en el caso de espejos con lamina safe.

INFORMACIÓN TÉCNICA ESTRUCTURA

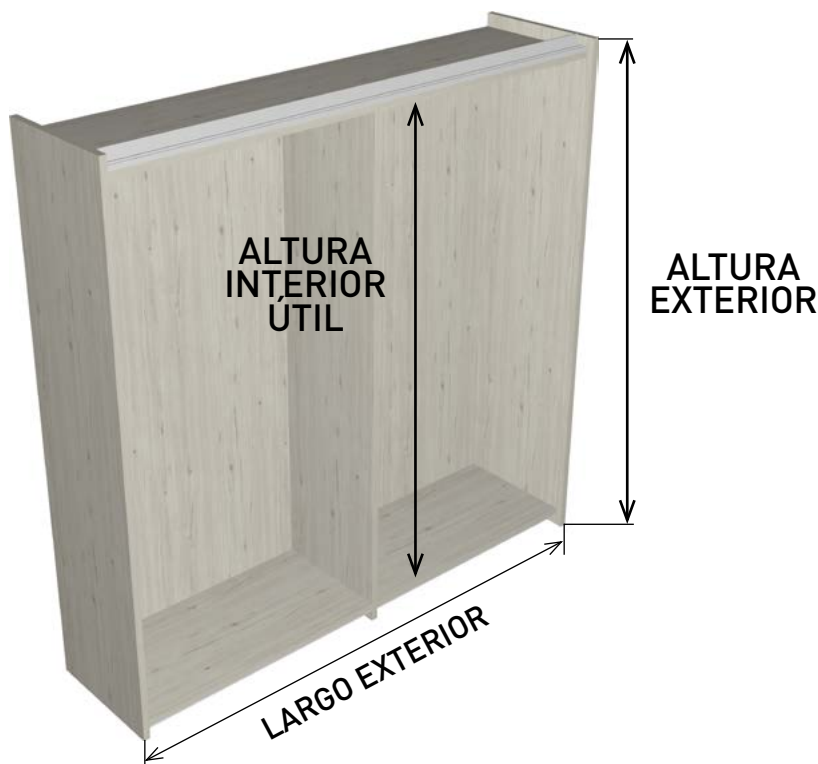

MEDIDAS A CONSIDERAR AL REALIZAR EL PEDIDO

$$\text{Altura interior útil} = \text{Altura armario} - 18\text{cm}$$

$$\text{Largo mínimo armario} = 150\text{cm}$$

$$\text{Fondo mínimo armario para contener una cajonera (Caja+Puerta)} = 47\text{cm}$$



MEDIDAS MÍNIMAS NECESARIAS PARA MONTAJE

$$\text{Altura hueco} = \text{Altura exterior armario} + 5\text{cm}$$

$$\text{Largo hueco} = \text{Largo exterior armario} + 5\text{cm}$$

CARACTERÍSTICAS TÉCNICAS PUERTAS CORREDERAS EXTERIORES

NUEVOS MODELOS DE PUERTAS



LUX

El catálogo **NOLIMITS NEXT** incorpora un nuevo modelo de puertas correderas, el modelo **LUX**. Se presentan en dos formatos distintos, 1 plafon y 3 plafones.

Ambos modelos de puertas **LUX**, incorporan refuerzos horizontales en la estructura metálica.

En el caso de las puertas de 1 plafon, quedan por detrás de este, quedando visibles cuando están compuestas por un panel de cristal translúcido o transparente.



LUX 3 PLAFONES

Para el formato de 3 plafones, los tirantes centrales quedan siempre visibles, y sirven para acomodar los distintos plafones.

Se sirven montadas.

NUEVOS ACABADOS FRENTES



Se incorporan 5 nuevos acabados **STONE**, para dar un acento original y elegante.



Gran variedad de acabados cristal, a escoger entre transparentes, translúcidos, lacados, relieves y espejos.

PASOS PARA CONFECCIONAR UN ARMARIO

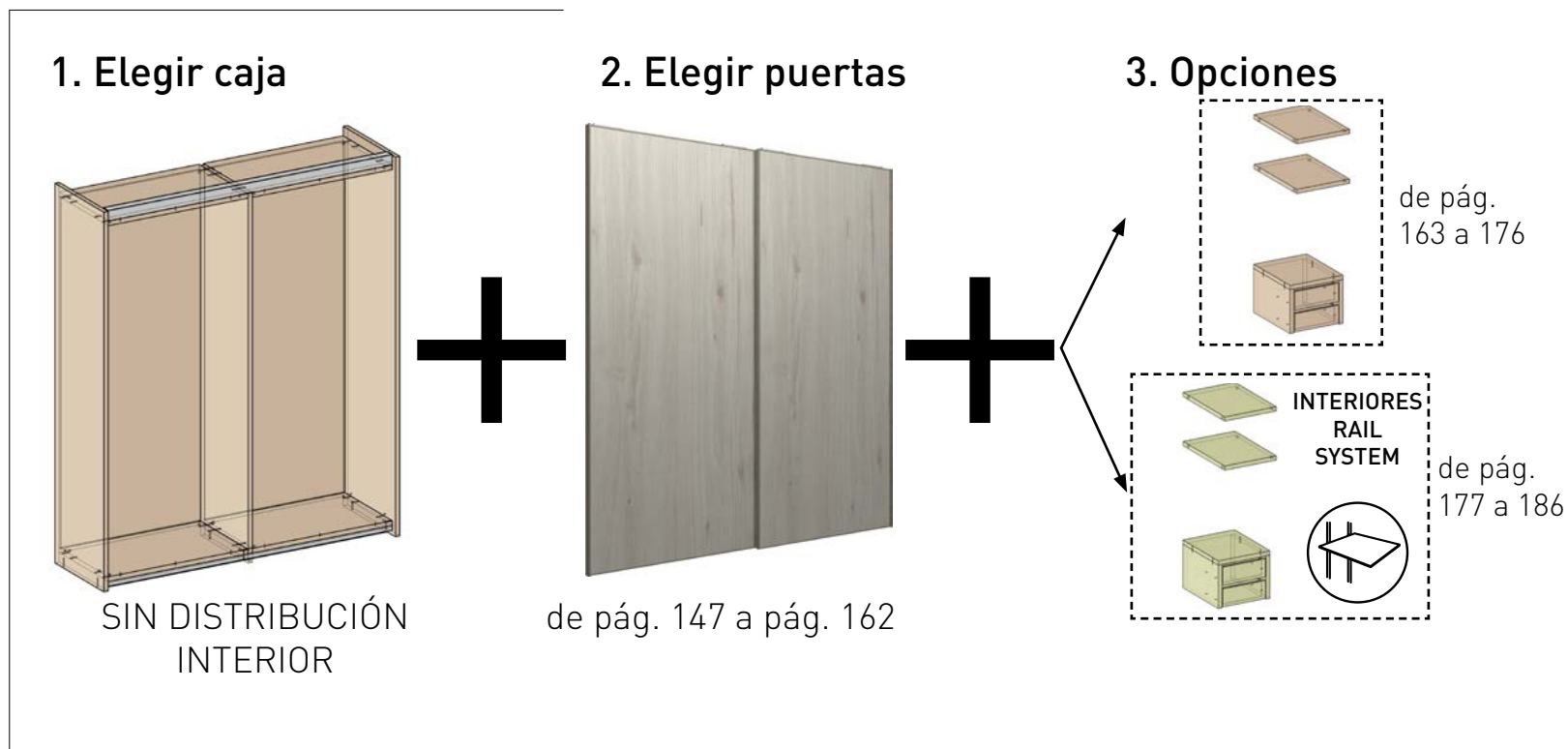

IMPRESINDIBLE ENVIAR DIBUJO DE LA DISTRIBUCIÓN INTERIOR.

MEDIDAS ESPECIALES

Elegir la medida superior y cortar, sin incremento.

CAJAS ARMARIO

Ancho mínimo de la caja es de 150cm.

Ancho mínimo de la puertas es de 75,4cm

PUERTAS

Ancho mínimo de la puertas es de 75,4cm

MONTAJE

Para montar un armario en un hueco es necesario disponer de **5cm** libres para su montaje lateral, y de **5cm** libres para su montaje superior. Si es posible montar el armario e introducir éste en el hueco, no hace falta disponer de las distancias marcadas anteriormente.

TACO

Información importante

Regulación entre 10 y 30mm para compensar desvío de suelo. Estos 10mm se deben tener en cuenta para la altura total (no están contabilizados en las medidas de tarifa)



EJEMPLO ELECCIÓN DE CAJA

El cliente desea un armario de 195 cm, de 239 cm de altura

Buscar la caja superior, en este caso 200 cm, que tiene dos cuerpos y su altura correspondiente

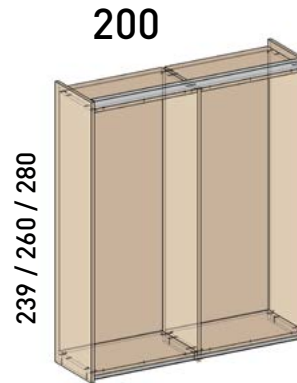

Altura	Ref.	Puntos
239	APC204	526
260	APC206	566
280	APC208	605

Que características tiene el armario y cual es su valor en puntos.

Con la referencia **APC204** tenemos un armario de 195 cm ancho y 239 cm alto.

El espacio interior que nos queda es menor que el del armario de 200 y las puertas lógicamente también quedan mas pequeñas, pero **siempre todas iguales**.

No hay incremento en los puntos por cortar el armario, por eso su valor es 526 puntos.

En resumen: Solo se tiene que elegir **526 a 195 cm** y jotajotape se encarga del resto.



150

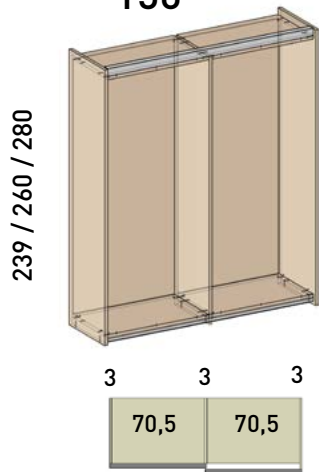

Altura	Ref.	Puntos
239	APC154	415
260	APC156	465
280	ACP158	505

Puertas de ancho 75,4.

160

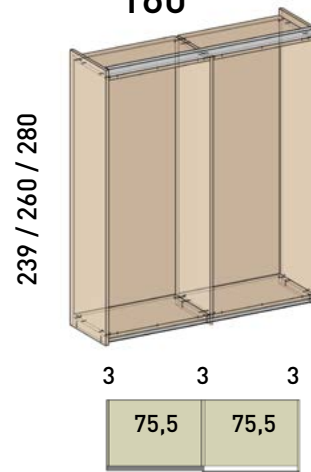

Altura	Ref.	Puntos
239	APC164	435
260	APC166	485
280	APC168	525

Puertas de ancho 80,4.

170

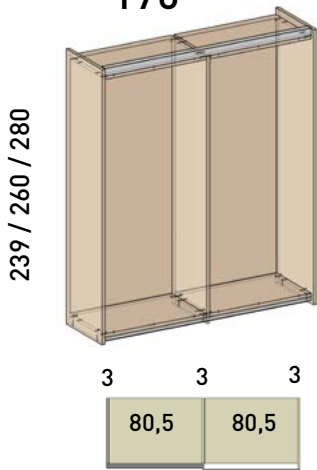

Altura	Ref.	Puntos
239	APC174	455
260	APC176	505
280	ACP178	545

Puertas de ancho 85,4.

180

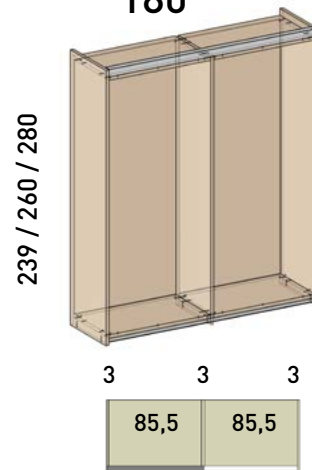

Altura	Ref.	Puntos
239	APC184	475
260	APC186	525
280	APC188	565

Puertas de ancho 90,4.

190

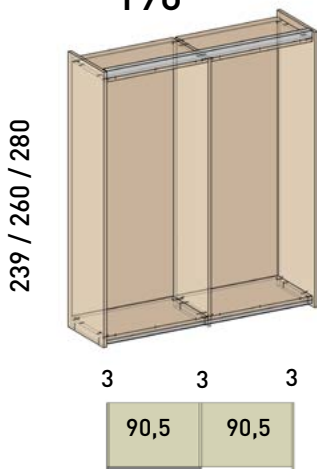

Altura	Ref.	Puntos
239	APC194	495
260	APC196	535
280	APC198	576

Puertas de ancho 95,4.

200

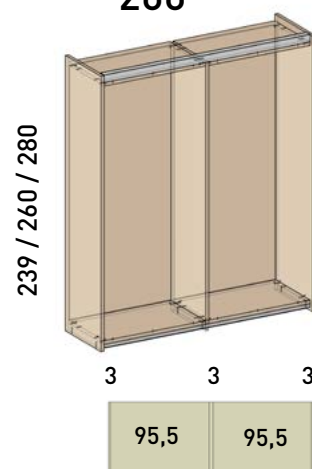

Altura	Ref.	Puntos
239	APC204	526
260	APC206	566
280	APC208	605

Puertas de ancho 100,4.

Para medidas intermedias, coger referencia de medida superior y cortar. Sin incremento por especial.

210

239 / 260 / 280

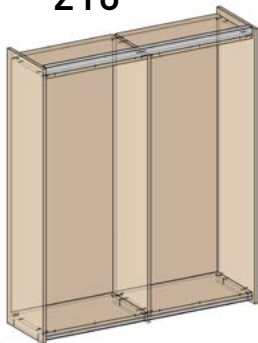

Altura	Ref.	Puntos
239	APC214	557
260	APC216	597
280	APC218	636

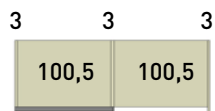

Puertas de ancho 105,4.

220

239 / 260 / 280

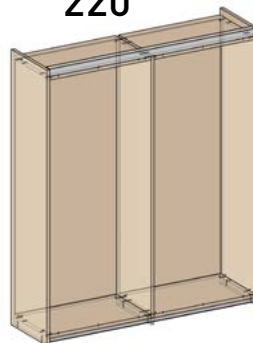

Altura	Ref.	Puntos
239	APC224	588
260	APC226	628
280	APC228	669

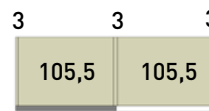

Puertas de ancho 110,4.

230

239 / 260 / 280

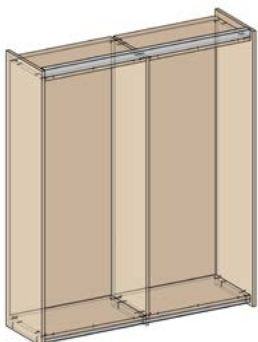

Altura	Ref.	Puntos
239	APC234	619
260	APC236	659
280	APC238	700

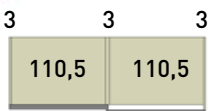

Puertas de ancho 115,4.

240

239 / 260 / 280

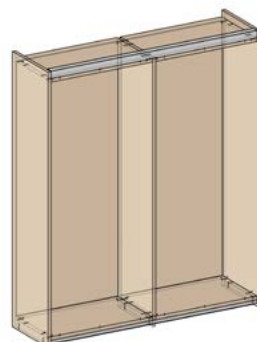

Altura	Ref.	Puntos
239	APC244	650
260	APC246	690
280	APC248	731

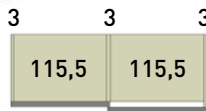

Puertas de ancho 120,4.

250

239 / 260 / 280

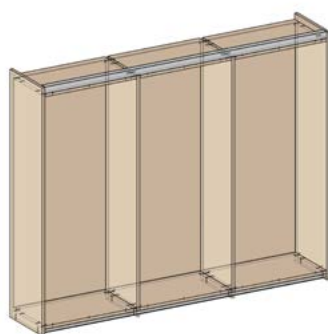

Altura	Ref.	Puntos
239	APC254	720
260	APC256	765
280	APC258	808

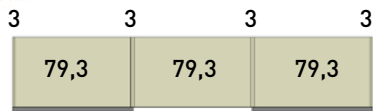

Puertas de ancho 83,9.

260

239 / 260 / 280

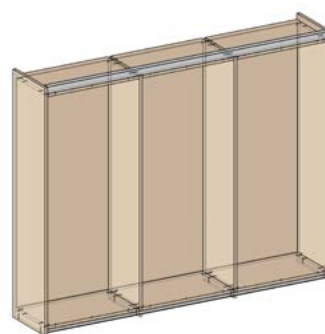

Altura	Ref.	Puntos
239	APC264	746
260	APC266	791
280	APC268	834

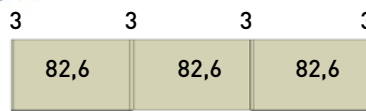

Puertas de ancho 87,3.

Para medidas intermedias, coger referencia de medida superior y cortar. Sin incremento por especial.

270

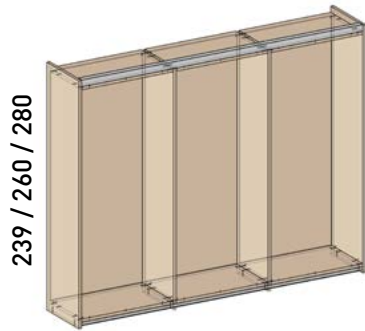

Altura	Ref.	Puntos
239	APC274	765
260	APC276	810
280	APC278	854

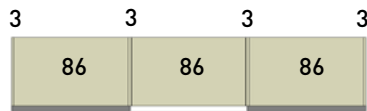

Puertas de ancho 90,6.

280

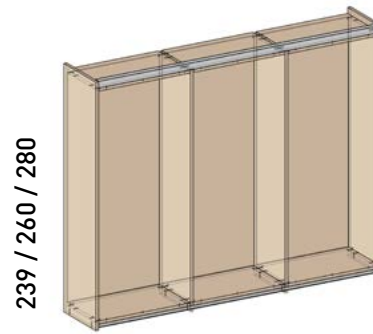

Altura	Ref.	Puntos
239	APC284	784
260	APC286	829
280	APC288	872

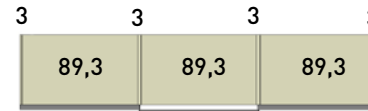

Puertas de ancho 93,9.

290

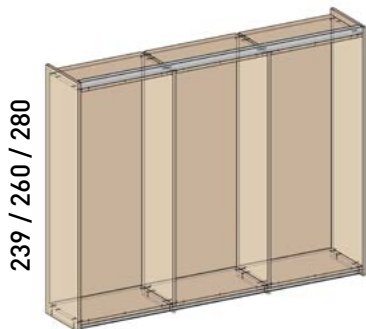

Altura	Ref.	Puntos
239	APC294	803
260	APC296	848
280	APC298	891

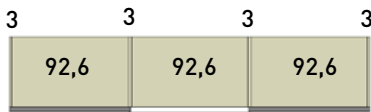

Puertas de ancho 97,3.

300

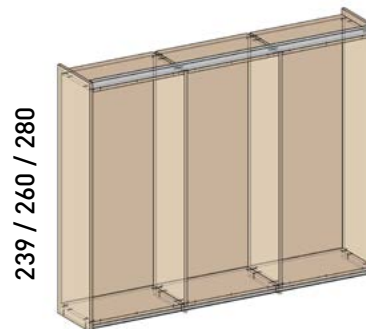

Altura	Ref.	Puntos
239	APC304	822
260	APC306	867
280	APC308	910

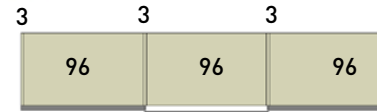

Puertas de ancho 100,6.

310

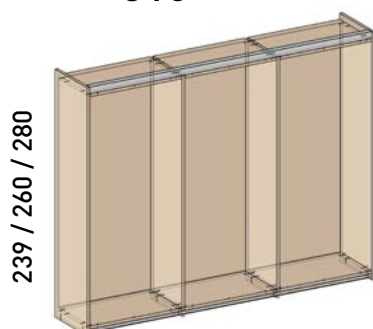

Altura	Ref.	Puntos
239	APC314	841
260	APC316	886
280	APC318	930

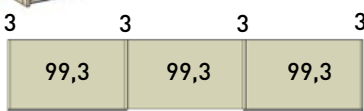

Puertas de ancho 103,9.

320

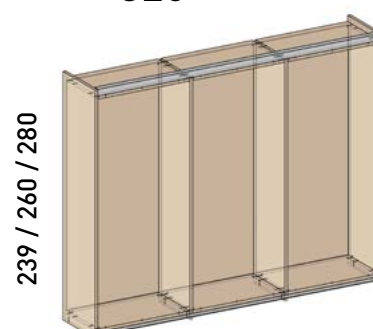

Altura	Ref.	Puntos
239	APC324	860
260	APC326	904
280	APC328	948

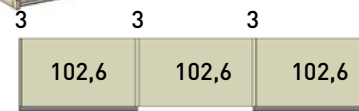

Puertas de ancho 107,3.

Para medidas intermedias, coger referencia de medida superior y cortar. Sin incremento por especial.

330

Altura	Ref.	Puntos
239	APC334	879
260	APC336	924
280	APC338	969

Puertas de ancho 110,6.

340

Altura	Ref.	Puntos
239	APC344	898
260	APC346	944
280	APC348	991

Puertas de ancho 113,9.

350

Altura	Ref.	Puntos
239	APC354	917
260	APC356	963
280	APC358	1008

Puertas de ancho 117,3.

360

Altura	Ref.	Puntos
239	APC364	936
260	APC366	982
280	APC368	1028

Puertas de ancho 120,6.

370

Altura	Ref.	Puntos
239	APC374	987
260	APC376	1034
280	APC378	1084

Puertas de ancho 93.

380

Altura	Ref.	Puntos
239	APC384	1012
260	APC386	1062
280	APC388	1112

Puertas de ancho 95,5.

Para medidas intermedias, coger referencia de medida superior y cortar. Sin incremento por especial.

390

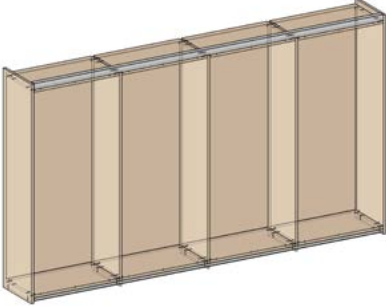

Altura	Ref.	Puntos
239	APC394	1036
260	APC396	1087
280	APC398	1137

239 / 260 / 280

3 3 3 3 3

93,7 93,7 93,7 93,7

Puertas de ancho 98.

400

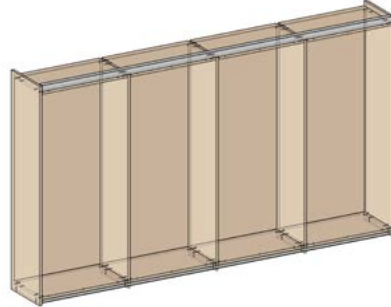

Altura	Ref.	Puntos
239	APC404	1060
260	APC406	1112
280	APC408	1162

239 / 260 / 280

3 3 3 3 3

96,2 96,2 96,2 96,2

Puertas de ancho 100,5.

410

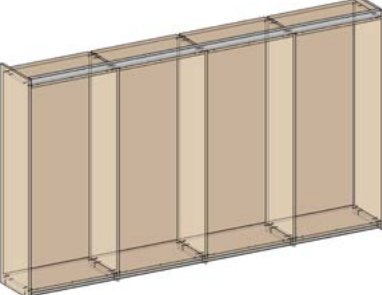

Altura	Ref.	Puntos
239	APC414	1084
260	APC416	1136
280	APC418	1187

239 / 260 / 280

3 3 3 3 3

98,7 98,7 98,7 98,7

Puertas de ancho 103.

420

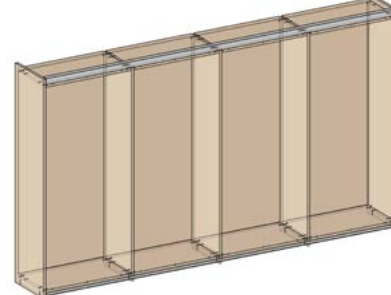

Altura	Ref.	Puntos
239	APC424	1108
260	APC426	1160
280	APC428	1211

239 / 260 / 280

3 3 3 3 3

101,2 101,2 101,2 101,2

Puertas de ancho 105,5.

430

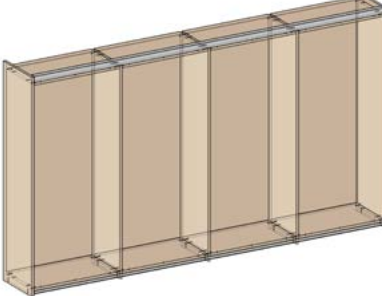

Altura	Ref.	Puntos
239	APC434	1132
260	APC436	1193
280	APC438	1245

239 / 260 / 280

3 3 3 3 3

103,7 103,7 103,7 103,7

Puertas de ancho 108.

440

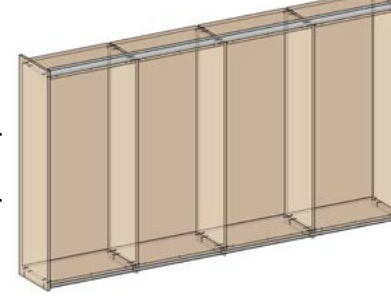

Altura	Ref.	Puntos
239	APC444	1156
260	APC446	1209
280	APC448	1263

239 / 260 / 280

3 3 3 3 3

106,2 106,2 106,2 106,2

Puertas de ancho 110,5.

Para medidas intermedias, coger referencia de medida superior y cortar. Sin incremento por especial.

450

Altura	Ref.	Puntos
239	APC454	1180
260	APC456	1218
280	APC458	1272

Puertas de ancho 113.

460

Altura	Ref.	Puntos
239	APC464	1204
260	APC466	1264
280	APC468	1319

Puertas de ancho 115,5.

470

Altura	Ref.	Puntos
239	APC474	1228
260	APC476	1289
280	APC478	1345

Puertas de ancho 118.

480

Altura	Ref.	Puntos
239	APC484	1252
260	APC486	1313
280	APC488	1370

Puertas de ancho 120,5.

Para medidas intermedias, coger referencia de medida superior y cortar. Sin incremento por especial.

EJEMPLO SELECCIÓN DE PUERTAS

El cliente desea unas puertas para un armario de 195 cm, de 239 cm de altura

Buscar las puertas deseadas, en este caso elegimos la de 1 plafón, con sus colores, su altura y el rango de medida.

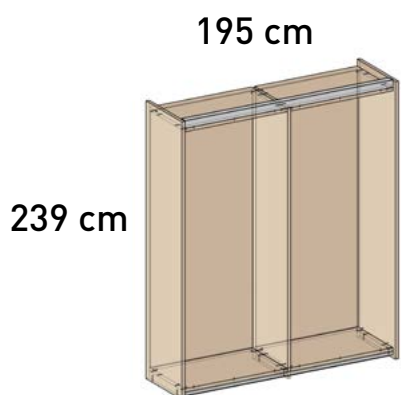

Buscar puertas para armario de 2 cuerpos



Puerta ancho de 75 a 120

		A			B		
		Altura	Ref	Puntos	Ref	Puntos	Acabados
Acabados CRISTAL	239	PVA404	880	PVB404	880		
	260	PVA406	910	PVB406	910		

Tenemos 2 referencias (una por cuerpo): **PVA404** y **PVB404** todas iguales adaptadas al armario de 195.

No hay incremento en los puntos por modificar las puertas, por eso nos quedan **1760 puntos** (las 2 puertas).



Acabados
puerta



Puertas
para armario de 2 cuerpos



Puerta ancho de 75 a 120

	A			B			Acabados
	Altura	Ref	Puntos	Ref	Puntos		
Acabados BASE	239	PCA204	399	PCB204	399		
	260	PCA206	433	PCB206	433		
	280	PCA208	453	PCB208	453		

Puertas
para armario de 3 cuerpos



Puerta ancho de 75 a 120

	A			B		C		Acabados
	Altura	Ref	Puntos	Ref	Puntos	Ref	Puntos	
Acabados BASE	239	PCA204	399	PCB204	399	PCC204	399	
	260	PCA206	433	PCB206	433	PCC206	433	
	280	PCA208	453	PCB208	453	PCC208	453	

Puertas
para armario de 4 cuerpos



Puerta ancho de 75 a 120

	A			D		E		C		Acabados
	Altura	Ref	Puntos	Ref	Puntos	Ref	Puntos	Ref	Puntos	
Acabados BASE	239	PCA204	399	PCD204	399	PCE204	399	PCC204	399	
	260	PCA206	433	PCD206	433	PCE206	433	PCC206	433	
	280	PCA208	543	PCD208	453	PCE208	453	PCC208	453	

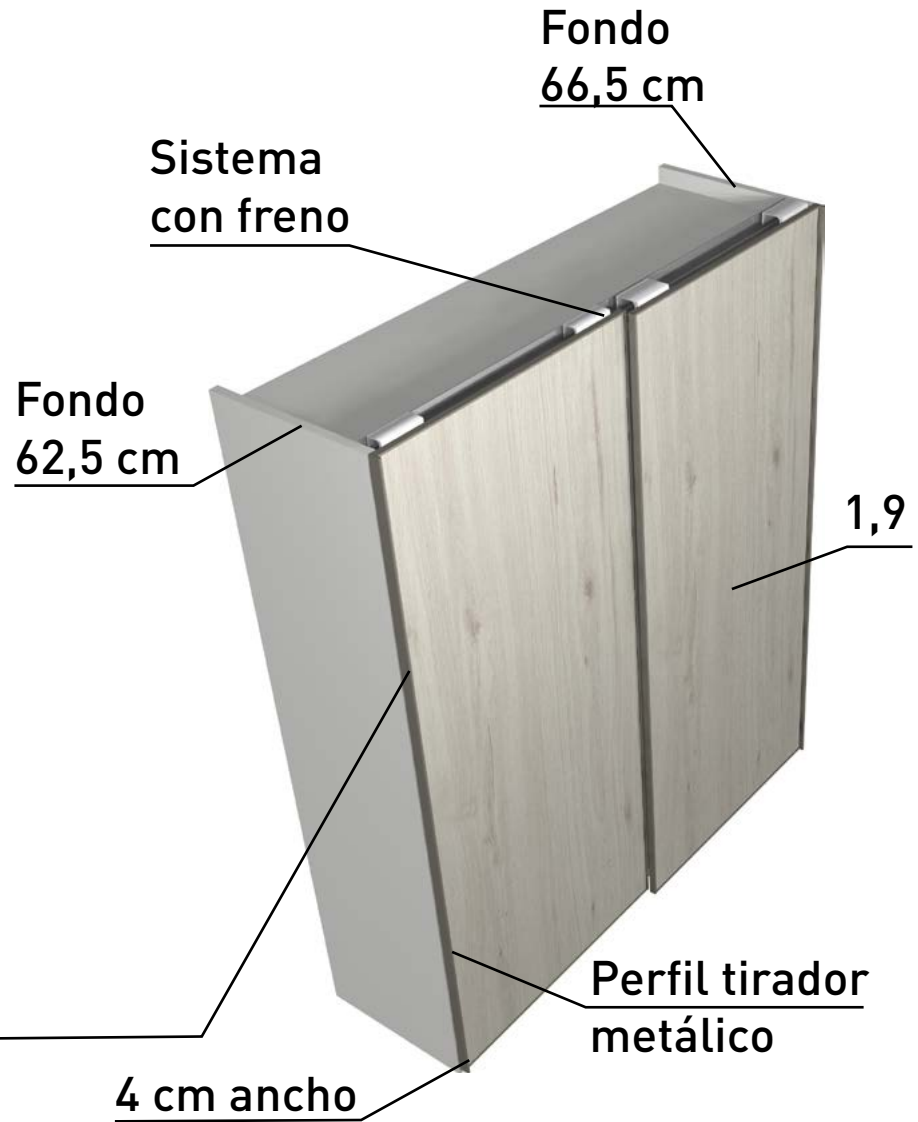

Acabados puerta



Acabados perfil



Puertas para armario de 2 cuerpos



Puerta ancho de 75 a 120

	Altura	A		B		Acabados
		Ref	Puntos	Ref	Puntos	
Acabados BASE	239	PCA304	291	PCB304	291	
	260	PCA306	314	PCB306	314	
	280	PCA308	329	PCB308	329	
Acabados STONE	239	PTA304	308	PTB304	308	
	260	PTA306	334	PTB306	334	
	280	PTA308	352	PTB308	352	

Puertas
para armario de 3 cuerpos



Puerta ancho de 75 a 120

	A			B		C		Acabados
	Altura	Ref	Puntos	Ref	Puntos	Ref	Puntos	
Acabados BASE	239	PCA304	291	PCB304	291	PCC304	291	
	260	PCA306	314	PCB306	314	PCC306	314	
	280	PCA308	329	PCB308	329	PCC308	329	
Acabados STONE	239	PTA304	308	PTB304	308	PTC304	308	
	260	PTA306	334	PTB306	334	PTC306	334	
	280	PTA308	352	PTB308	352	PTC308	352	

Puertas
para armario de 4 cuerpos



Puerta ancho de 75 a 120

	A			D		E		C		Acabados
	Altura	Ref	Puntos	Ref	Puntos	Ref	Puntos	Ref	Puntos	
Acabados BASE	239	PCA304	291	PCD304	291	PCE304	291	PCC304	291	
	260	PCA306	314	PCD306	314	PCE306	314	PCC306	314	
	280	PCA308	329	PCD308	329	PCE308	329	PCC308	329	
Acabados STONE	239	PTA304	308	PTD304	308	PTE304	308	PTC304	308	
	260	PTA306	334	PTD306	334	PTE306	334	PTC306	334	
	280	PTA308	352	PTD308	352	PTE308	352	PTC308	352	



Cuatro ranuras por puerta.

Fondo 66,5 cm

Sistema con freno

Fondo 62,5 cm

1,9

Acabados puerta



Acabados perfil



4 cm ancho

Perfil tirador metálico

14 puntos por ranura extra.

*Indica el color de la ranura.

Puertas para armario de 2 cuerpos



Puerta ancho de 75 a 120

A

B

	Altura	Ref	Puntos	Ref	Puntos	Acabados
Acabados BASE	239	PCA284	347	PCB284	347	
	260	PCA286	370	PCB286	370	
	280	PCA288	385	PCB288	385	
Acabados STONE	239	PTA284	364	PTB284	364	
	260	PTA286	390	PTB286	390	
	280	PTA288	408	PTB288	408	

Puertas
para armario de 3 cuerpos



Puerta ancho de 75 a 120

	Altura	A			B		C		Acabados
		Ref	Puntos	Ref	Puntos	Ref	Puntos		
Acabados BASE	239	PCA284	347	PCB284	347	PCC284	347		
	260	PCA286	370	PCB286	370	PCC286	370		
	280	PCA288	385	PCB288	385	PCC288	385		
Acabados STONE	239	PTA284	364	PTB284	364	PTC284	364		
	260	PTA286	390	PTB286	390	PTC286	390		
	280	PTA288	408	PTB288	408	PTC288	408		

Puertas
para armario de 4 cuerpos



Puerta ancho de 75 a 120

	Altura	A			D		E		C		Acabados
		Ref	Puntos	Ref	Puntos	Ref	Puntos	Ref	Puntos		
Acabados BASE	239	PCA284	347	PCD284	347	PCE284	347	PCC284	347		
	260	PCA286	370	PCD286	370	PCE286	370	PCC286	370		
	280	PCA288	385	PCD288	385	PCE288	385	PCC288	385		
Acabados STONE	239	PTA284	364	PTD284	364	PTE284	364	PTC284	364		
	260	PTA286	390	PTD286	390	PTE286	390	PTC286	390		
	280	PTA288	408	PTD288	408	PTE288	408	PTC288	408		

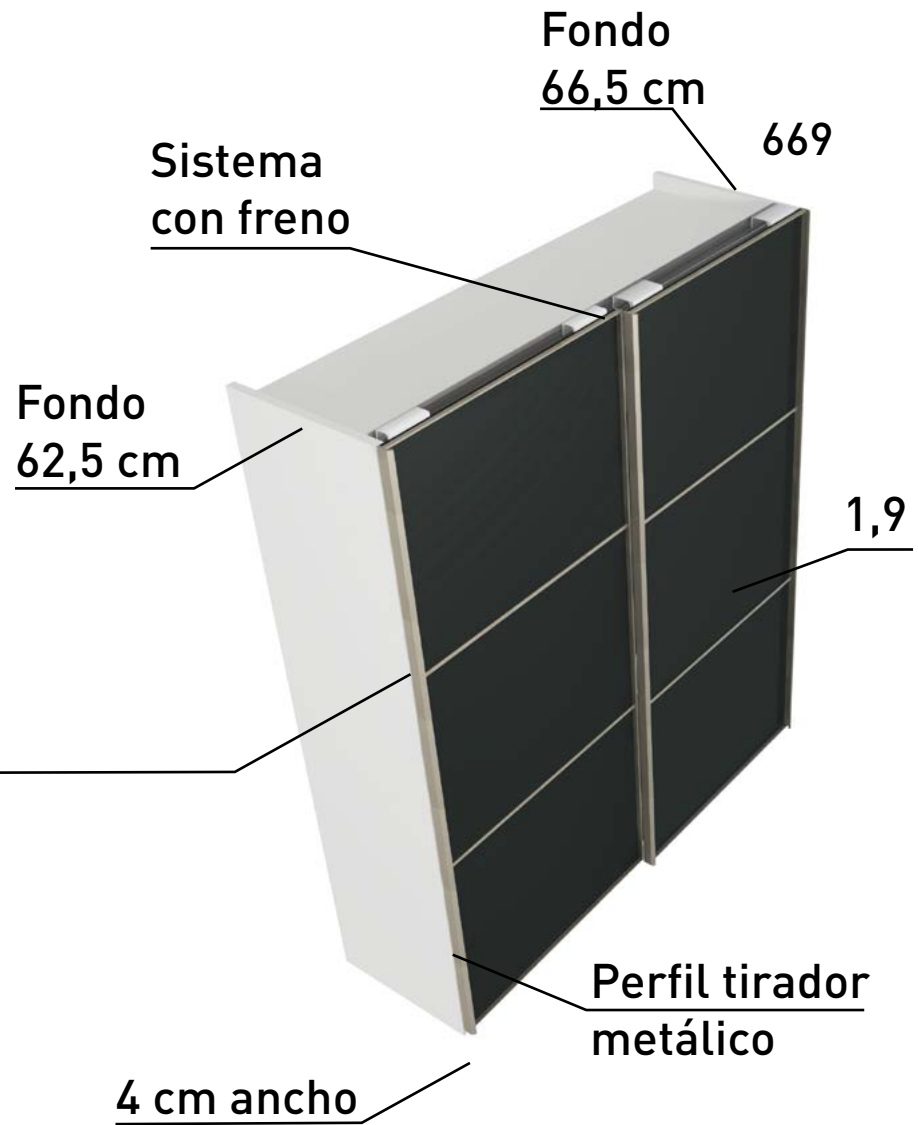

Acabados puerta



Acabados perfil



Puertas para armario de 2 cuerpos



Puerta ancho de 75 a 120

	A			B		
	Altura	Ref	Puntos	Ref	Puntos	Acabados
Acabados BASE	239	PCA344	317	PCB344	317	
	260	PCA346	342	PCB346	342	
	280	PCA348	359	PCB348	359	
Acabados STONE	239	PTA344	334	PTB344	334	
	260	PTA346	352	PTB346	352	
	280	PTA348	382	PTB348	382	

Puertas
para armario de 3 cuerpos



Puerta ancho de 75 a 120

	A			B			C			Acabados
	Altura	Ref	Puntos	Ref	Puntos	Ref	Puntos	Ref	Puntos	
Acabados BASE	239	PCA344	317	PCB344	317	PCC344	317			
	260	PCA346	342	PCB346	342	PCC346	342			
	280	PCA348	359	PCB348	359	PCC348	359			
Acabados STONE	239	PTA344	334	PTB344	334	PTC344	334			
	260	PTA346	352	PTB346	352	PTC346	352			
	280	PTA348	382	PTB348	382	PTC348	382			

Puertas
para armario de 4 cuerpos



Puerta ancho de 75 a 120

	A			D			E			C			Acabados
	Altura	Ref	Puntos	Ref	Puntos	Ref	Puntos	Ref	Puntos	Ref	Puntos		
Acabados BASE	239	PCA344	317	PCD344	317	PCE344	317	PCC344	317				
	260	PCA346	342	PCD346	342	PCE346	342	PCC346	342				
	280	PCA348	359	PCD348	359	PCE348	359	PCC348	359				
Acabados STONE	239	PTA344	334	PTD344	334	PTE344	334	PTC344	334				
	260	PTA346	352	PTD346	352	PTE346	352	PTC346	352				
	280	PTA348	382	PTD348	382	PTE348	382	PTC348	382				

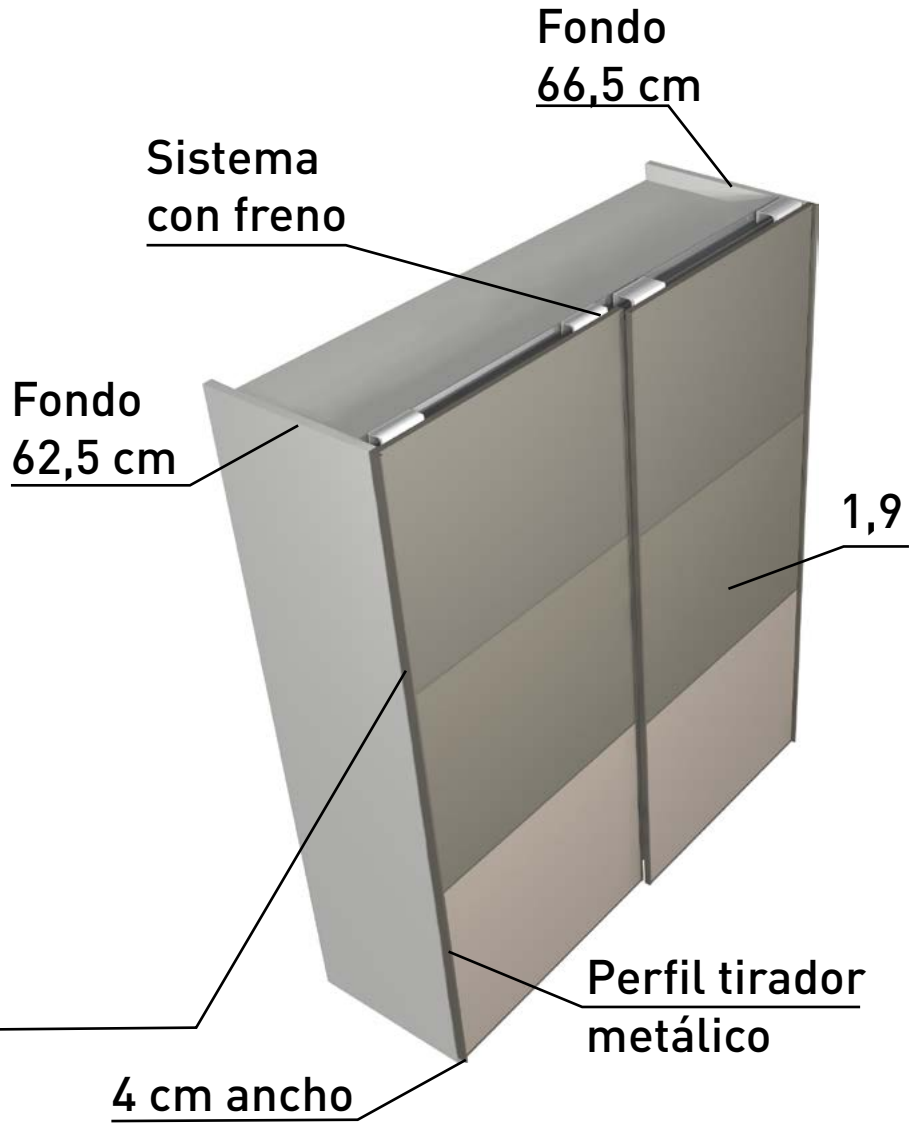
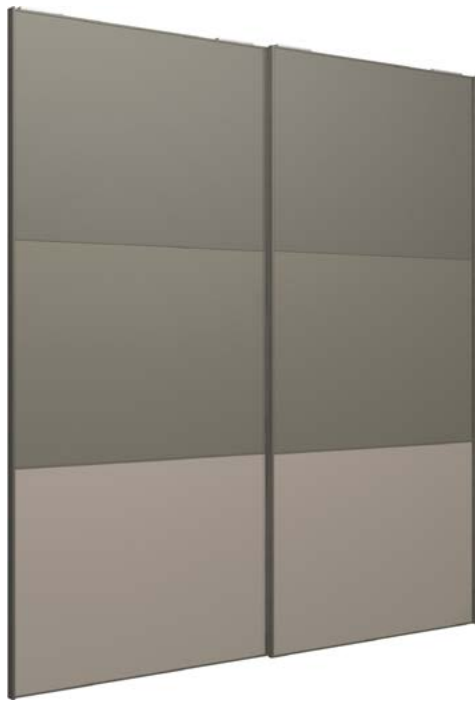

Acabados puerta



Acabados perfil



Puertas para armario de 2 cuerpos

Puerta A	Puerta B
1	1
2	2
3 Puerta interior	3 Puerta exterior

Puerta ancho de 75 a 120

	A			B		
	Altura	Ref	Puntos	Ref	Puntos	Acabados
Acabados BASE	239	PCA364	339	PCB364	339	
	260	PCA366	366	PCB366	366	
	280	PCA368	382	PCB368	382	

Puertas
para armario de 3 cuerpos

Puerta A	Puerta B	Puerta C
1	1	1
2	2	2
3 <small>Puerta interior</small>	3 <small>Puerta exterior</small>	3 <small>Puerta interior</small>

Puerta ancho de 75 a 120

		A			B		C		
		Altura	Ref	Puntos	Ref	Puntos	Ref	Puntos	Acabados
Acabados BASE	239	PCA364	339	PCB364	339	PCC364	339		
	260	PCA366	366	PCB366	366	PCC366	366		
	280	PCA368	382	PCB368	382	PCC368	382		

Puertas
para armario de 4 cuerpos

Puerta A	Puerta D	Puerta E	Puerta C
1	1	1	1
2	2	2	2
3 <small>Puerta interior</small>	3 <small>Puerta exterior</small>	3 <small>Puerta exterior</small>	3 <small>Puerta interior</small>

Puerta ancho de 75 a 120

		A			D		E		C		
		Altura	Ref	Puntos	Ref	Puntos	Ref	Puntos	Ref	Puntos	Acabados
Acabados BASE	239	PCA364	339	PCD364	339	PCE364	339	PCC364	339		
	260	PCA366	366	PCD366	366	PCE366	366	PCC366	366		
	280	PCA368	382	PCD368	382	PCE368	382	PCC368	382		

Combinar solo con puertas enmarcadas modelo LUX

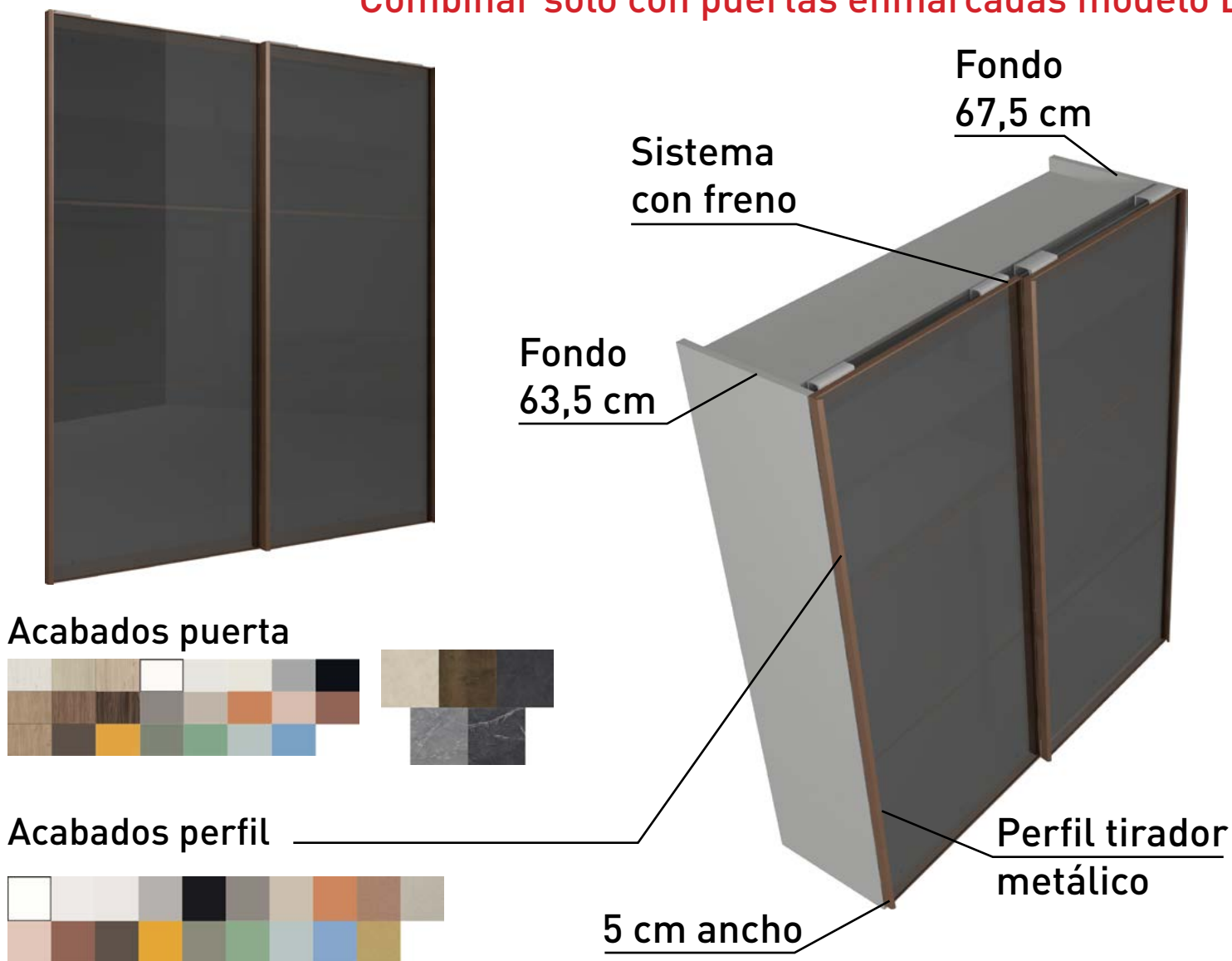

Puertas para armario de 2 cuerpos

Puerta ancho de 75 a 120



	A			B		Acabados
	Altura	Ref	Puntos	Ref	Puntos	
Acabados CRISTAL	239	PVA404	880	PVB404	880	
	260	PVA406	910	PVB406	910	
Acabados STONE	239	PTA404	680	PTB404	680	
	260	PTA406	695	PTB406	695	
Acabados BASE	239	PCA404	660	PCB404	660	
	260	PCA406	675	PCB406	675	

Puertas
para armario de 3 cuerpos



Puerta ancho de 75 a 120

	A			B			C			Acabados
	Altura	Ref	Puntos	Ref	Puntos	Ref	Puntos	Ref	Puntos	
Acabados CRISTAL	239	PVA404	880	PVB404	880	PVC404	880			
	260	PVA406	910	PVB406	910	PVC406	910			
Acabados STONE	239	PTA404	680	PTB404	680	PTC404	680			
	260	PTA406	695	PTB406	695	PTC406	695			
Acabados BASE	239	PCA404	660	PCB404	660	PCC404	660			
	260	PCA406	675	PCB406	675	PCC406	675			

Puertas
para armario de 4 cuerpos



Puerta ancho de 75 a 120

	A			D			E			C			Acabados
	Altura	Ref	Puntos	Ref	Puntos	Ref	Puntos	Ref	Puntos	Ref	Puntos		
Acabados CRISTAL	239	PVA404	880	PVD404	880	PVE404	880	PVC404	880				
	260	PVA406	910	PVD406	910	PVE406	910	PVC406	910				
Acabados STONE	239	PTA404	680	PTD404	680	PTE404	680	PTC404	680				
	260	PTA406	695	PTD406	695	PTE406	695	PTC406	695				
Acabados BASE	239	PCA404	660	PCD404	660	PCE404	660	PCC404	660				
	260	PCA406	675	PCD406	675	PCE406	675	PCC406	675				

Combinar solo con puertas enmarcadas modelo LUX

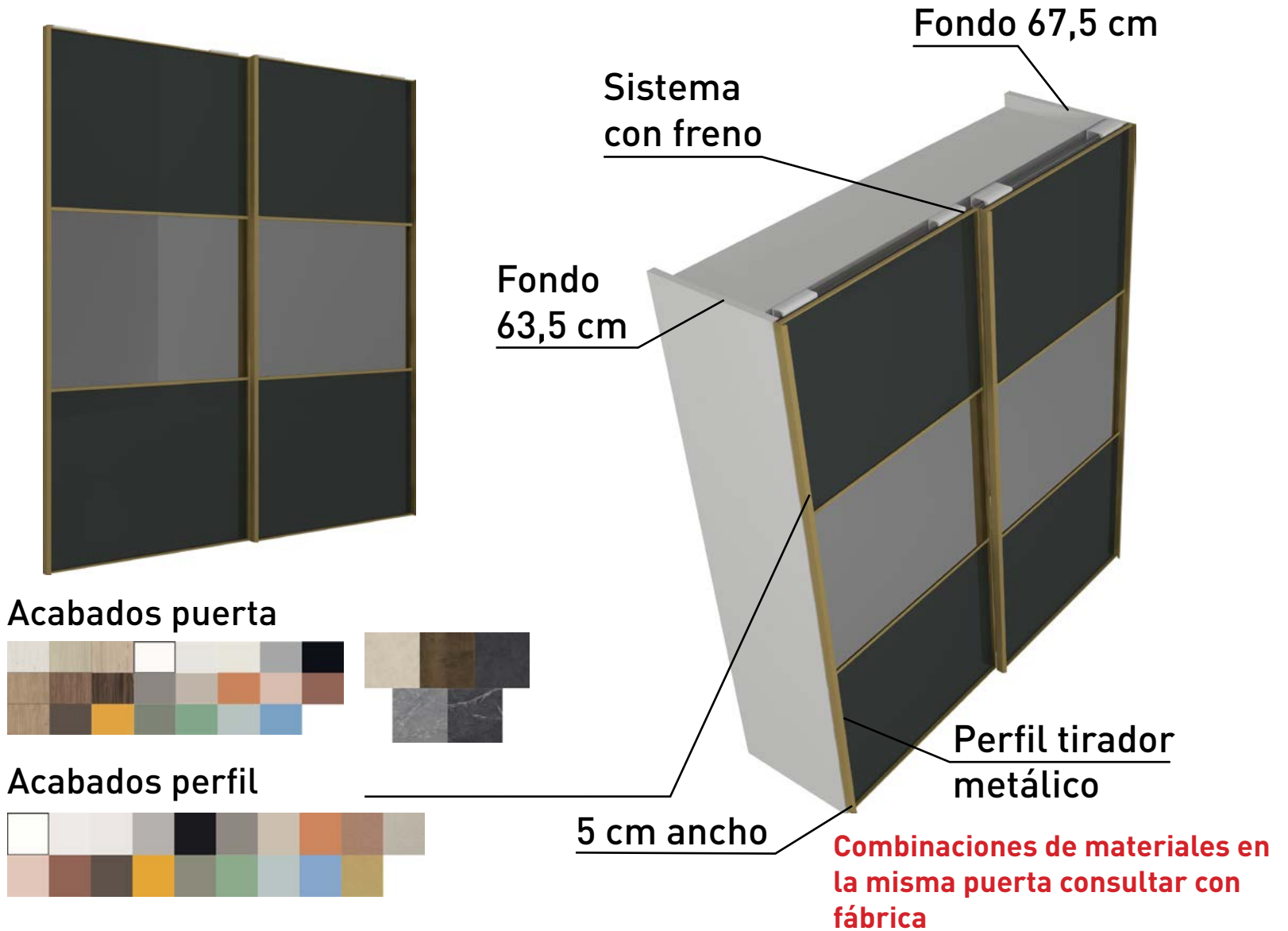

Puerta ancho de 75 a 120

A **B**

Puertas para armario de 2 cuerpos



Puerta A	Puerta B
1	1
2	2
3 Puerta interior	3 Puerta exterior

	Altura	Ref	Puntos	Ref	Puntos	Acabados
Acabados CRISTAL	239	PVA414	885	PVB414	885	
	260	PVA416	915	PVB416	915	
Acabados STONE	239	PTA414	685	PTB414	685	
	260	PTA416	700	PTB416	700	
Acabados BASE	239	PCA414	665	PCB414	665	
	260	PCA416	675	PCB416	675	

Puertas
para armario de 3 cuerpos

Puerta A	Puerta B	Puerta C
1	1	1
2	2	2
3 Puerta interior	3 Puerta exterior	3 Puerta interior



Puerta ancho de 75 a 120

	A			B			C			Acabados
	Altura	Ref	Puntos	Ref	Puntos	Ref	Puntos	Ref	Puntos	
Acabados CRISTAL	239	PVA414	885	PVB414	885	PVC414	885			
	260	PVA416	915	PVB416	915	PVC416	915			
Acabados STONE	239	PTA414	685	PTB414	685	PTC414	685			
	260	PTA416	700	PTB416	700	PTC416	700			
Acabados BASE	239	PCA414	665	PCB414	665	PCC414	665			
	260	PCA416	675	PCB416	675	PCC416	675			

Puertas
para armario de 4 cuerpos

Puerta A	Puerta D	Puerta E	Puerta C
1	1	1	1
2	2	2	2
3 Puerta interior	3 Puerta exterior	3 Puerta exterior	3 Puerta interior

Puerta ancho de 75 a 120

	A			D			E			C			Acabados
	Altura	Ref	Puntos	Ref	Puntos	Ref	Puntos	Ref	Puntos	Ref	Puntos		
Acabados CRISTAL	239	PVA414	885	PVD414	885	PVE414	885	PVC414	885				
	260	PVA416	915	PVD416	915	PVE416	915	PVC416	915				
Acabados STONE	239	PTA414	685	PTD414	685	PTE414	685	PTC414	685				
	260	PTA416	700	PTD416	700	PTE416	700	PTC416	700				
Acabados BASE	239	PCA414	665	PCD414	665	PCE414	665	PCC414	665				
	260	PCA416	675	PCD416	675	PCE416	675	PCC416	675				

EJEMPLO ELECCIÓN DE INTERIORES

Deseamos añadir 2 estantes, una barra de colgar y una cajonera al interior de un armario de 195 cm, de 239 cm de altura.

Buscar las opciones de interior deseadas para un hueco interior de 93.

Al modificar el armario de 200 a 195 las medidas de hueco son 93.

Ref.	Puntos
ET80	34
ET80	34
BC10	28
CG3310	276

Las opciones de interior se adaptan a la medida exacta del hueco interior.

No hay incremento en los puntos por recortar las opciones, son un total de **269 puntos**.

OPCIONES PARA ARMARIOS CORREDEROS

ESTANTES FONDO 55

Grosor 3

hasta 40



de 40,1 a 50



de 50,1 a 60



de 60,1 a 80



Ref.	ET84	ET85	ET86	ET88
Puntos	22	25	29	32

Grosor 3

de 80,1 a 100



de 100,1 a 120

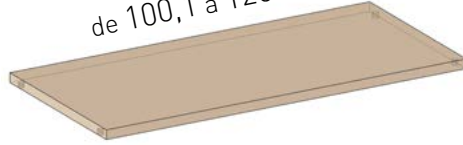

Ref.	ET80	ET82
Puntos	34	39

ESTANTES EXTRAIBLE FONDO 55

Grosor 3

hasta 40



de 40,1 a 50



de 50,1 a 60



de 60,1 a 80



Ref.	ETT84	ETT85	ETT86	ETT88
Puntos	54	57	61	64

Grosor 3

de 80,1 a 100

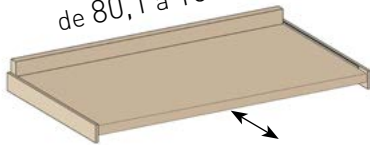

de 100,1 a 120

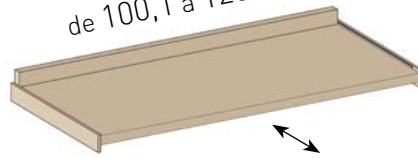

Ref.	ETT80	ETT82
Puntos	66	71

BARRAS



Blanco

Vulcano

hasta 40



de 40,1 a 50

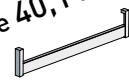

de 50,1 a 60

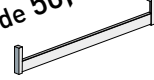

de 60,1 a 80

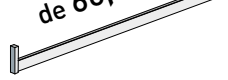

de 80,1 a 100

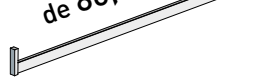

de 100,1 a 120

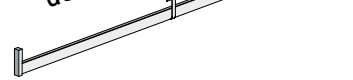

Incorpora 3 soportes.

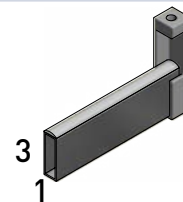

Barra rectangular con 2 soportes de fijación a costado o estante. Perfil superior minimiza ruido

Ref.	BC4	BC5	BC6	BC8	BC10	BC12
Puntos	16	19	22	25	28	35

ESTANTES CRISTAL FONDO 55

Grosor 0.6

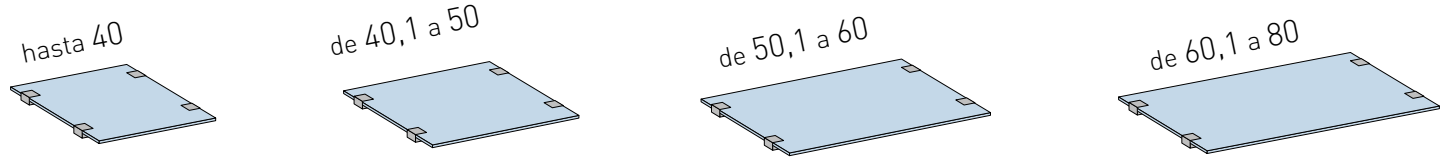

Ref.	EV43	EV53	EV63	EV83
Puntos	54	62	70	85

Grosor 0.6

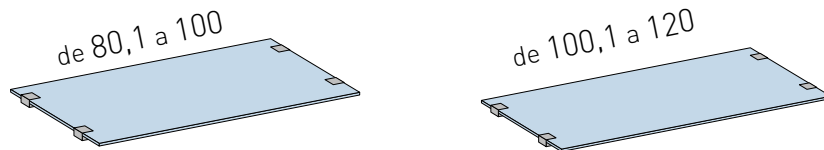

Acabados cristal transparente y opaco

Acabados soporte estante cristal

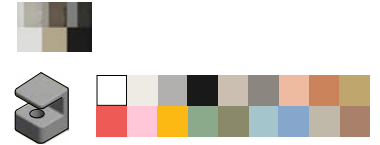

Ref.	EV103	EV123
Puntos	114	130

PARTIDORES FONDO 55

Grosor 3

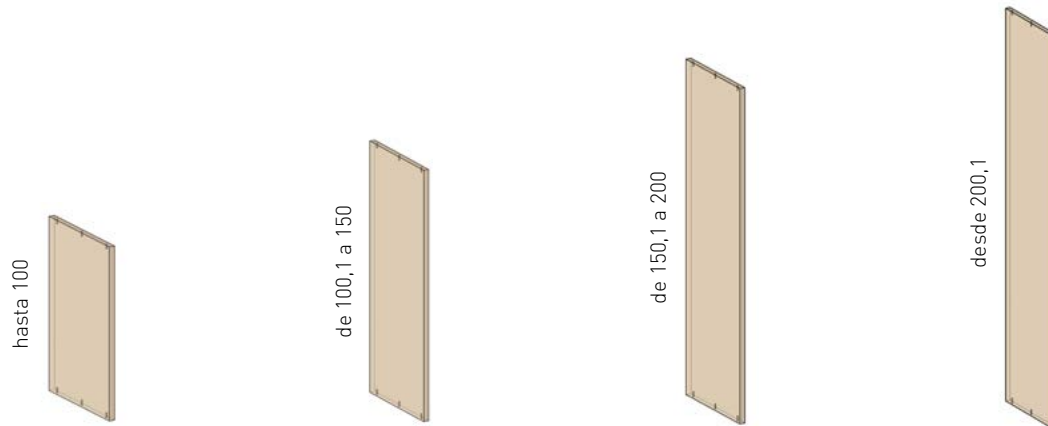

Ref.	DNT103	DNT153	DNT203	DNT303
Puntos	49	54	58	64

ZAPATERO FIJO FONDO 55

Grosor 3

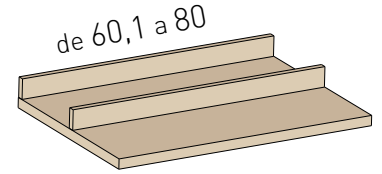
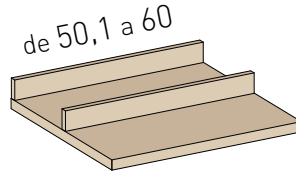
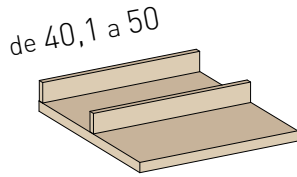
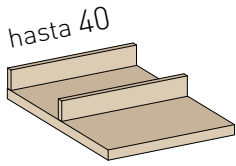

Ref.	EZ43	EZ53	EZ63	EZ83
Puntos	34	38	43	47

Grosor 3

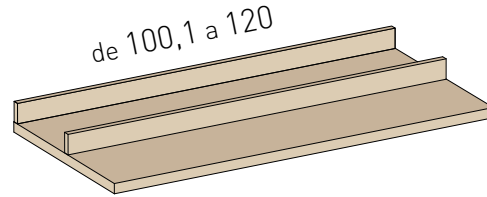
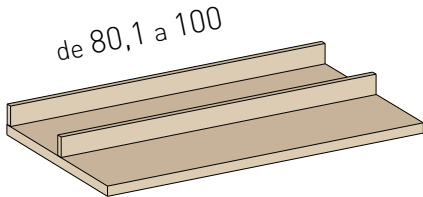

Ref.	EZ103	EZ123
Puntos	50	56

ZAPATERO EXTRAÍBLE FONDO 55

Grosor 3

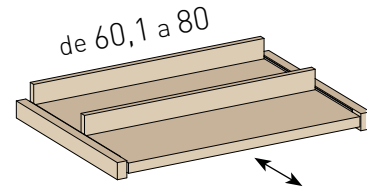
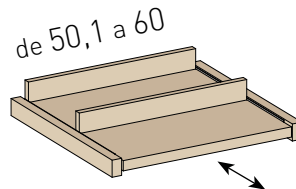
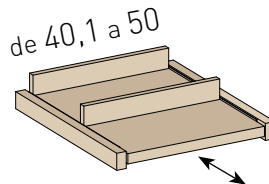
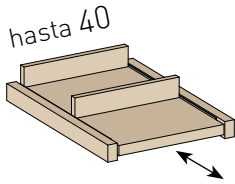

Ref.	EX43	EX53	EX63	EX83
Puntos	59	63	68	72

Grosor 3

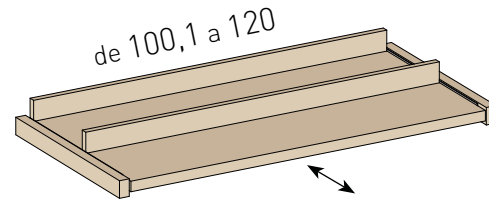
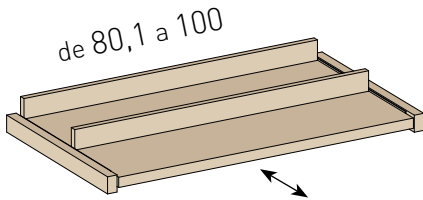

Ref.	EX103	EX123
Puntos	75	81

ZAPATERO INCLINADO FONDO 55

* Medidas especiales de fondo consultar con fábrica

Grosor 3

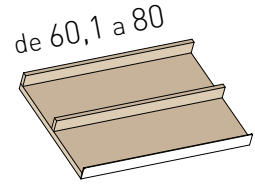
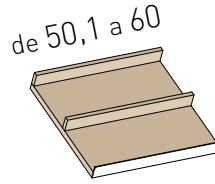
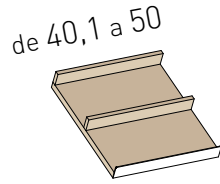
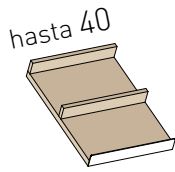

Ref.	EN43	EN53	EN63	EN83
Puntos	40	44	49	53

Grosor 3

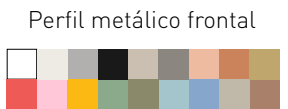
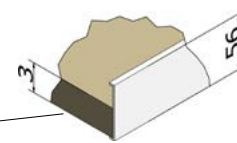
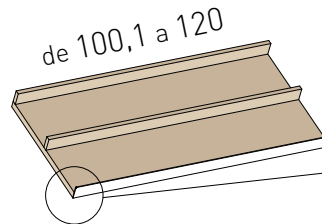
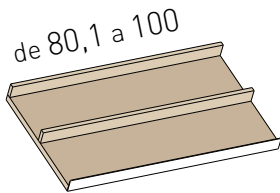

Ref.	EN103	EN123
Puntos	56	62

OPCIONES

Zapatero extensible y extraíble

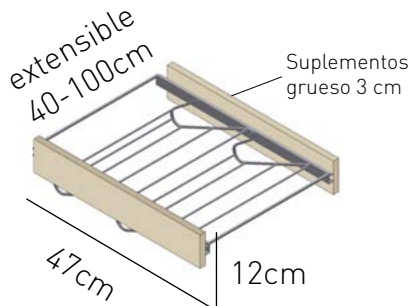

Barra abatible y extensible



Mesa planchar plegable



Ref.	ZPR	BRT	TPL
Puntos	100	110	168

LEDS

*Sensor movimiento incorporado

1 tira de led



2 tiras de leds



Ref.	LED10	LED20
Puntos	168	288

COSTILLA 11

Altura 21,5

hasta 60



de 60,1 a 80



de 80,1 a 100



de 100,1 a 120



Ref.	CG1316	CG1318	CG1310	CG1312
Puntos	107	127	144	204

Altura 37

hasta 60



de 60,1 a 80



de 80,1 a 100



de 100,1 a 120



Ref.	CG2316	CG2318	CG2310	CG2312
Puntos	159	187	210	308

Altura 52,5

hasta 60



de 60,1 a 80



de 80,1 a 100



de 100,1 a 120



Ref.	CG3316	CG3318	CG3310	CG3312
Puntos	211	247	276	411

Altura 68

hasta 60



de 60,1 a 80



de 80,1 a 100



de 100,1 a 120



Ref.	CG4316	CG4318	CG4310	CG4312
Puntos	263	307	342	516

Altura 83,5

hasta 60



de 60,1 a 80



de 80,1 a 100



de 100,1 a 120



Ref.	CG5316	CG5318	CG5310	CG5312
Puntos	315	367	408	620

Altura 99

hasta 60



de 60,1 a 80



de 80,1 a 100



de 100,1 a 120



Ref.	CG6316	CG6318	CG6310	CG6312
Puntos	367	427	474	724

COSTILLA 16

Altura 26,5

hasta 60



de 60,1 a 80



de 80,1 a 100



de 100,1 a 120



Ref.	CG1366	CG1368	CG1360	CG1362
Puntos	111	131	148	212

Altura 47

hasta 60



de 60,1 a 80



de 80,1 a 100



de 100,1 a 120



Ref.	CG2366	CG2368	CG2360	CG2362
Puntos	167	195	218	324

Altura 67,5

hasta 60



de 60,1 a 80



de 80,1 a 100



de 100,1 a 120



Ref.	CG3366	CG3368	CG3360	CG3362
Puntos	223	259	288	436

Altura 88

hasta 60



de 60,1 a 80



de 80,1 a 100



de 100,1 a 120



Ref.	CG4366	CG4368	CG4360	CG4362
Puntos	279	323	358	548

Altura 108,5

hasta 60



de 60,1 a 80



de 80,1 a 100



de 100,1 a 120



Ref.	CG5366	CG5368	CG5360	CG5362
Puntos	335	387	428	660

CAJONERAS PARA COLGAR FONDO 55

Altura 18,5	COSTILLA 11			Altura 23,5	COSTILLA 16		
	hasta 60	de 60,1 a 80	de 80,1 a 100		hasta 60	de 60,1 a 80	de 80,1 a 100
Ref.	CG156C	CG158C	CG150C	CG166C	CG168C	CG160C	
Puntos	87	101	112	90	104	115	

Altura 34	COSTILLA 11			Altura 44	COSTILLA 16		
	hasta 60	de 60,1 a 80	de 80,1 a 100		hasta 60	de 60,1 a 80	de 80,1 a 100
Ref.	CG256C	CG258C	CG250C	CG266C	CG268C	CG260C	
Puntos	137	158	174	143	164	180	

CAJONES SEPARADORES

Incremento por separadores (Cajón no incluido)

Altura 18,5	Incremento por separadores (Cajón no incluido)		
	de 60,1 a 80	de 80,1 a 100	de 100,1 a 120
Ref.	CRB685	CRB105	CRB125
Puntos	30	34	42

CASILLERO FONDO 55

Altura 36	Incremento por separadores (Cajón no incluido)		
	de 60,1 a 80	de 80,1 a 100	de 100,1 a 120
Ref.	CS82	CS102	CS122
Puntos	96		

PANTALONEROS FONDO 55

Altura 18,5	Incremento por separadores (Cajón no incluido)		
	hasta 60	de 60,1 a 80	de 80,1 a 100
Ref.	PNT606	PNT686	PNT106
Puntos	150	164	180

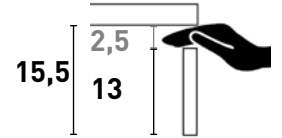

Disponibles cajones de 11, 16 y 25 cm de alto en costilla.



Ancho total de 40 a 60		Ancho total de 60,1 a 80		Ancho total de 80,1 a 100	
Altura Costilla	Altura Total	Altura Costilla	Altura Total	Altura Costilla	Altura Total
11	15,5	11	15,5	11	15,5
16	20,5	16	20,5	16	20,5
22	29,5	22	29,5	22	29,5



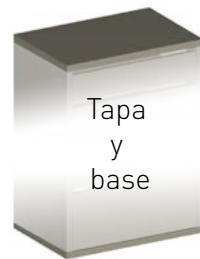















Ref.	Puntos	Ref.	Puntos	Ref.	Puntos
CGN316	52	CGN318	60	CGN310	66
CGN366	56	CGN368	64	CGN360	70
CGN356	69	CGN358	77	CGN350	73

El precio de los lados de la cajonera va incluido en cada cajón.

Ancho total de 40 a 60	Ancho total de 60,1 a 80	Ancho total de 80,1 a 100
 <p>Tapa y base</p>	 <p>Tapa y base</p>	 <p>Tapa y base</p>
Ref. CFN346	Ref. CFN368	Ref. CFN380
Puntos 55	Puntos 67	Puntos 78

Seleccionar altura y cantidad de cajones + una tapa (obligatoria), todos del mismo ancho.
Con estas referencias ya podemos crear la cajonera de libre composición.

Ejemplo de cajonera de 40 a 60:

<table border="0"> <tr> <td>11</td> <td></td> <td>CGN316</td> <td>52</td> </tr> <tr> <td>16</td> <td></td> <td>CGN366</td> <td>56</td> </tr> <tr> <td>16</td> <td></td> <td>CGN366</td> <td>56</td> </tr> <tr> <td>22</td> <td></td> <td>CGN356</td> <td>56</td> </tr> </table>	11		CGN316	52	16		CGN366	56	16		CGN366	56	22		CGN356	56	+	<table border="0"> <tr> <td></td> <td>CFN346</td> <td>55</td> </tr> </table>		CFN346	55	=	<table border="0"> <tr> <td></td> <td>CFN346</td> <td>3</td> <td>Altura Tapa</td> </tr> <tr> <td></td> <td>CGN316</td> <td>15,5</td> <td>Altura Costilla 11</td> </tr> <tr> <td></td> <td>CGN366</td> <td>20,5</td> <td>Altura Costilla 16</td> </tr> <tr> <td></td> <td>CGN366</td> <td>20,5</td> <td>Altura Costilla 16</td> </tr> <tr> <td></td> <td>CGN356</td> <td>29,5</td> <td>Altura Costilla 22</td> </tr> <tr> <td></td> <td></td> <td>3</td> <td></td> </tr> <tr> <td colspan="2">Puntos Total</td> <td colspan="2">Altura Total</td> </tr> <tr> <td colspan="2">(52 + 56 + 56 + 69) + 55</td> <td colspan="2">(3 + 15,5 + 20,5 + 20,5 + 29,5 + 3)</td> </tr> <tr> <td colspan="2">288</td> <td colspan="2">92</td> </tr> </table>		CFN346	3	Altura Tapa		CGN316	15,5	Altura Costilla 11		CGN366	20,5	Altura Costilla 16		CGN366	20,5	Altura Costilla 16		CGN356	29,5	Altura Costilla 22			3		Puntos Total		Altura Total		(52 + 56 + 56 + 69) + 55		(3 + 15,5 + 20,5 + 20,5 + 29,5 + 3)		288		92	
11		CGN316	52																																																								
16		CGN366	56																																																								
16		CGN366	56																																																								
22		CGN356	56																																																								
	CFN346	55																																																									
	CFN346	3	Altura Tapa																																																								
	CGN316	15,5	Altura Costilla 11																																																								
	CGN366	20,5	Altura Costilla 16																																																								
	CGN366	20,5	Altura Costilla 16																																																								
	CGN356	29,5	Altura Costilla 22																																																								
		3																																																									
Puntos Total		Altura Total																																																									
(52 + 56 + 56 + 69) + 55		(3 + 15,5 + 20,5 + 20,5 + 29,5 + 3)																																																									
288		92																																																									

ESTRUCTURA

Cajón frente cristal

Costillas laterales acabado único ANTRACITA

Acero

Cristal templado

Frente cristal FOSCO

Acabados laminados base cajón



Cajón frente cristal

Costillas laterales acabado único ANTRACITA

Acero

Cristal templado

Frente cristal FOSCO

Acabados laminados base cajón

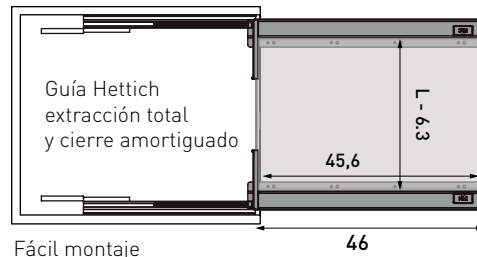
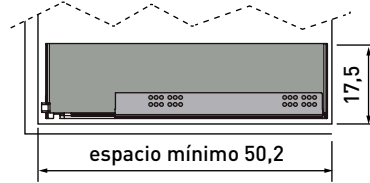

Fácil montaje
Espaciador para salvar bisagras incorporado

L hueco armario	Ref.	Puntos
40-50	CF140	171
50-60	CF150	177
60-70	CF160	180
70-80	CF170	191
80-90	CF180	198
90-100	CF190	204
100-110	CF100	211
110-116	CF110	218

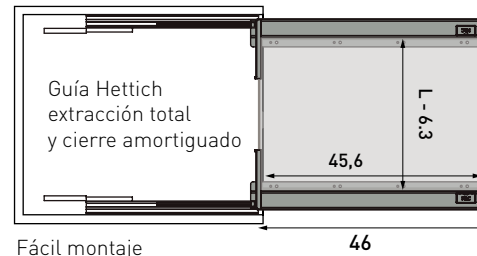
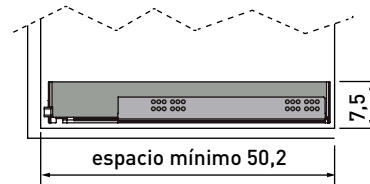

Fácil montaje
Espaciador para salvar bisagras incorporado

L hueco armario	Ref.	Puntos
40-50	CF740	158
50-60	CF750	162
60-70	CF760	166
70-80	CF770	173
80-90	CF780	179
90-100	CF790	186
100-110	CF700	193
110-116	CF711	201

COMPLEMENTOS

Joyero organizador

Acabado TITANIO

Piel ecológica y madera

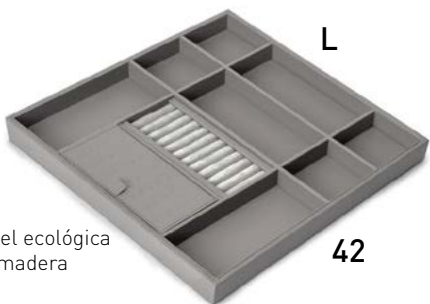

L	Ref.	Puntos
44	JR4	88
54	JR5	100
64	JR6	112
74	JR7	124

Caja accesorios

Acabado único ANTRACITA
Acero

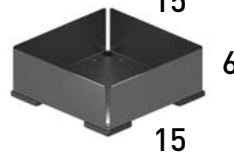

L	Ref.	Puntos
15	CAJ15	24

Bandeja accesorios

Acabado único ANTRACITA
Acero



L	Ref.	Puntos
28	BAN28	28
45	BAN45	30

ESTRUCTURA

Cajón zapatero frente cristal

Costillas laterales acabado único ANTRACITA

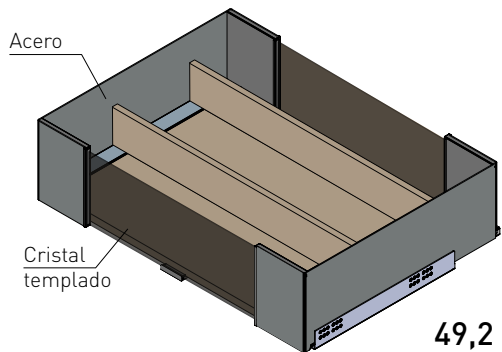

Frente cristal FOSCO

Acabados laminados base cajón

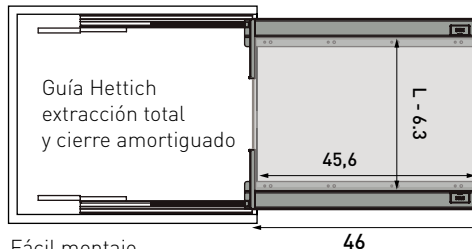
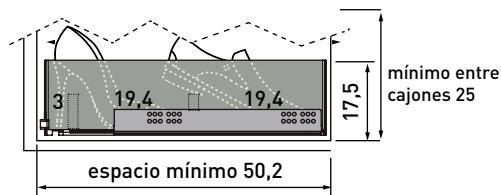

Fácil montaje
Espaciador para salvar bisagras incorporado

L hueco armario	Ref.	Puntos
40-50	CZ40	184
50-60	CZ50	191
60-70	CZ60	199
70-80	CZ70	210
80-90	CZ80	219
90-100	CZ90	226
100-110	CZ10	235
110-116	CZ11	242

COLGADORES

Perchero Abatible

Acabado único ANTRACITA
Acero

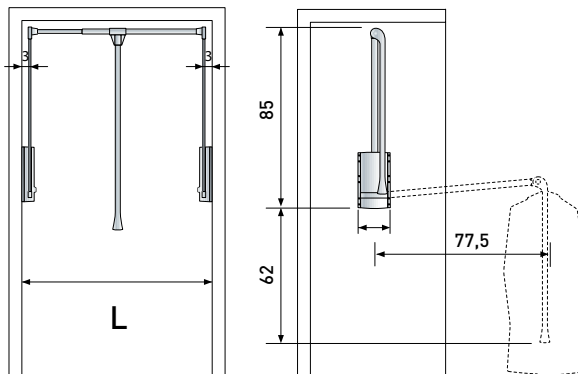
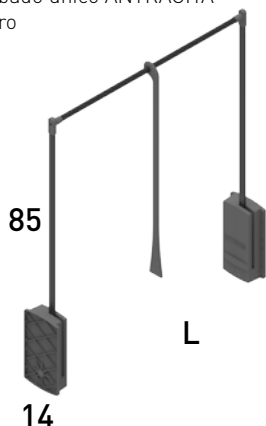

L hueco armario	Ref.	Puntos
44-60	PER4	114
60-90	PER6	130
90-116	PER7	134

Perchero extraíble SUPERIOR

Acabado único ANTRACITA
Acero

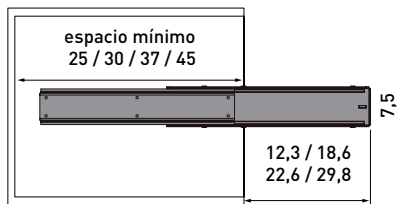

Carga máxima 15kg
Necesita estante superior

P	Ref.	Puntos
24	PEX24	44
29	PEX29	46
36	PEX36	48
44	PEX44	50

Barras colgar

Acabado ANTRACITA
Aluminio

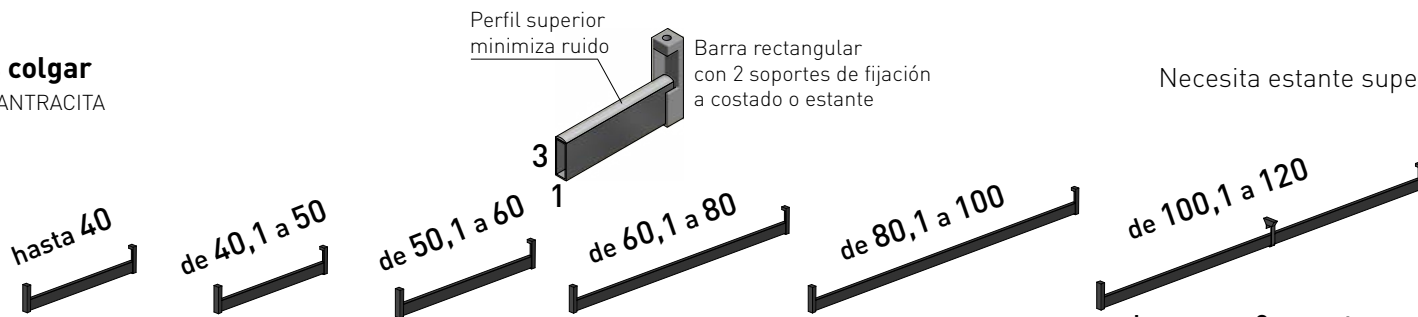

Incorpora 3 soportes.

Ref.	BL40	BL50	BL60	BL80	BL10	BL12
Puntos	18	21	25	27	30	38

Zapatero lateral extraíble

Acabado único ANTRACITA
Acero

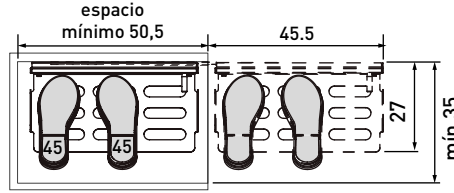
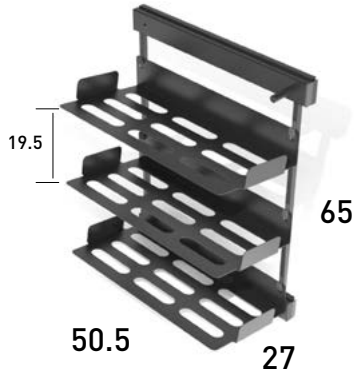

Espaciador para salvar bisagras incorporado

L	Ref.	Puntos
DR	Z65D	196
IZ	Z65Z	196

Cesta de tela

Estructura ANTRACITA
Acero / Tela gris

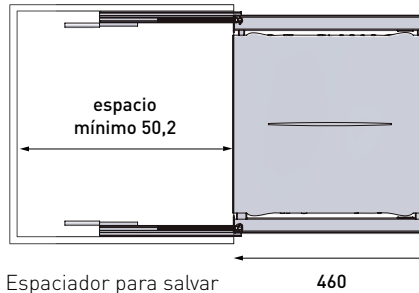

Espaciador para salvar bisagras incorporado

L	Ref.	Puntos
53,5-58,5	CET5	226
58,5-63,5	CET6	234

Corbatero lateral extraíble

Acabado único ANTRACITA
Acero

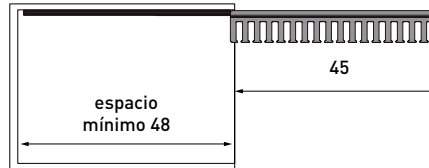
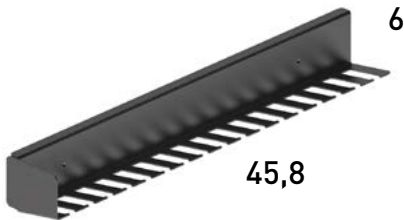

Espaciador para salvar bisagras incorporado

L	Ref.	Puntos
DR	CORD	65
IZ	CORZ	65

Espejo lateral extraíble

Acabado único GRAFITO

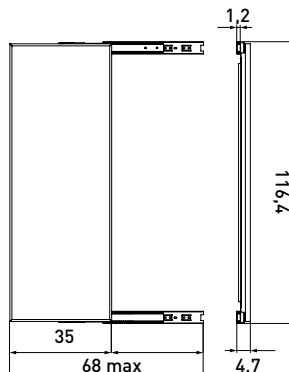
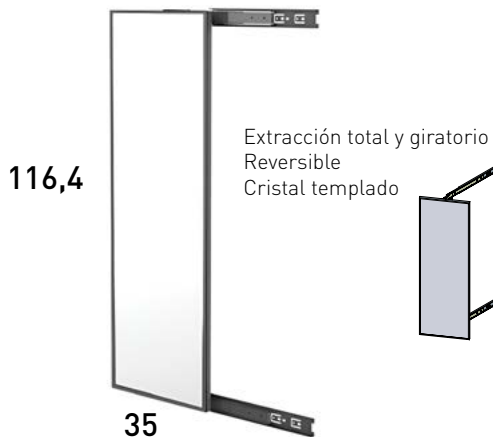

Espaciador para salvar bisagras incorporado

L	Ref.	Puntos
35	ESPEX	90

Guía Hettich extracción total y cierre amortiguado
Soportes con funda antideslizante

PANTALONEROS

Bandeja pantalonero

Acabado único ANTRACITA
Acero

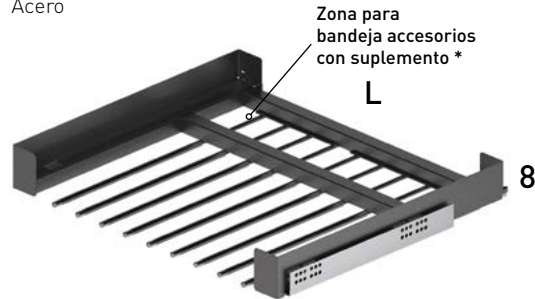

Carga máxima 30kg

49

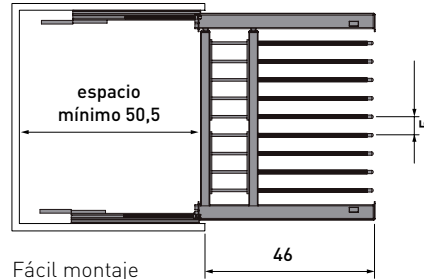

Fácil montaje
Espaciador para salvar bisagras incorporado

Soportes	L	Ref.	Puntos
7-9	50,5-60,5	PAX60	204
9-11	60,5-70,5	PAX70	209
11-13	70,5-80,5	PAX80	219
13-15	80,5-90,5	PAX90	227

Bandeja accesorios

Acabado único ANTRACITA



* Bandejas recomendadas según medida
de 50,5 a 65,5 cm 1 unidad
de 65,5 a 85,5 cm 2 unidades
de 85,5 a 90,5 cm 3 unidades

Ref.	Puntos
BDA24	14

Pantalonero extraíble LATERAL

Acabado único ANTRACITA
Acero

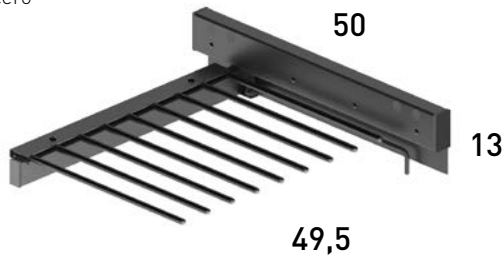

Reversible
Para 9 pantalones

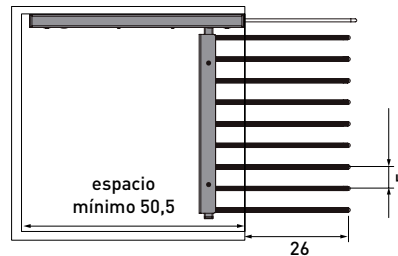

Espaciador para salvar bisagras incorporado

Ref.	Puntos
PAXL	133

Pantalonero extraíble SUPERIOR

Acabado único ANTRACITA
Acero

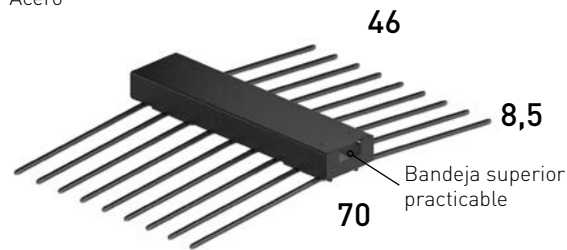

Para 18 pantalones.
Necesita estante superior

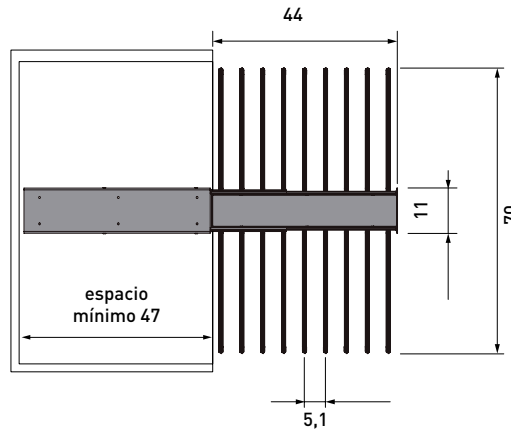

Ref.	Puntos
PAX18	148

Pantalonero extraíble SUPERIOR

Acabado único ANTRACITA
Acero

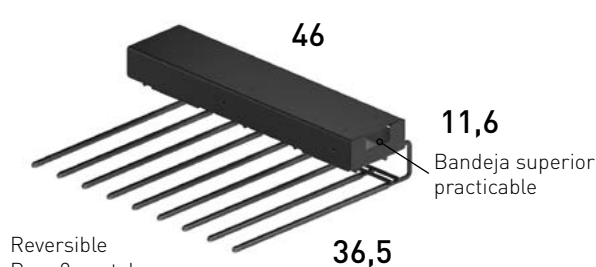

Reversible
Para 9 pantalones
Necesita estante superior

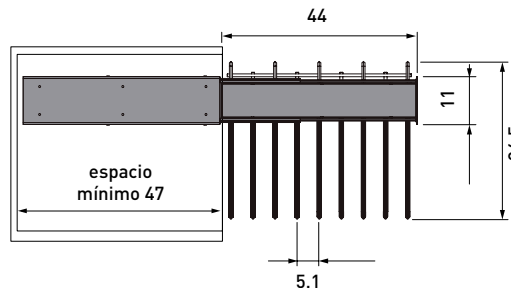

Ref.	Puntos
PAX9	112



Estructuras para interiores de armario
(Interiores no regulables en altura)



Columnas aluminio

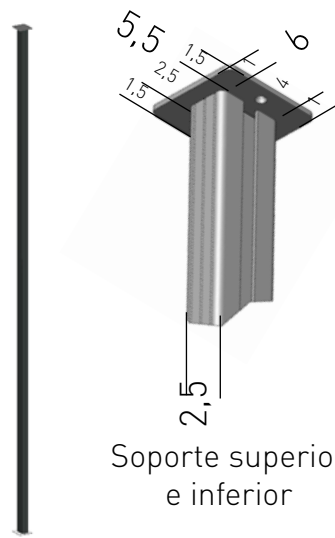

Altura	Ref.	Puntos
150 - 200	CAL1	86
201 - 274	CAL2	96

- Blanco
- Vulcano

Estos estantes no tienen mano.



ESTANTES FONDO 55

Grueso 3

<i>hasta 40</i>	<i>de 40,1 a 50</i>	<i>de 50,1 a 60</i>
1 soporte incluido + 2 soportes UX	1 soporte incluido + 2 soportes UX	1 soporte incluido + 2 soportes UX

Ref.	ET94	ET95	ET96
Puntos	37	40	44

Grueso 3

<i>de 60,1 a 80</i>	<i>de 80,1 a 100</i>	<i>de 100,1 a 120</i>
1 soporte incluido + 2 soportes UX	1 soporte incluido + 2 soportes UX	1 soporte incluido + 2 soportes UX

Ref.	ET98	ET90	ET92
Puntos	47	49	54



ESTANTES EXTRAIBLE FONDO 55

No tiene mano
Soportes incluidos

Grosor 3

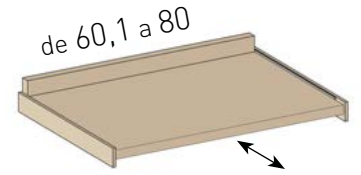
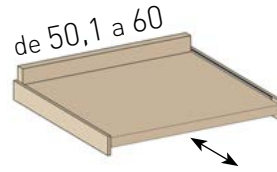
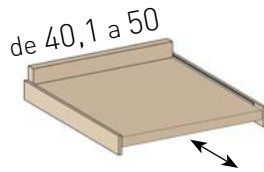
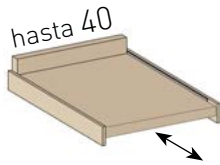

Ref.	ETX44	ETX54	ETX64	ETX84
Puntos	69	72	76	79

ESTANTES CRISTAL FONDO 55

No tiene mano
Soportes incluidos

Grosor 0.6

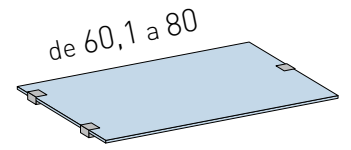
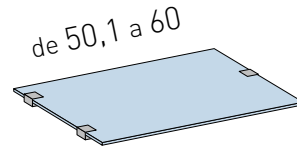
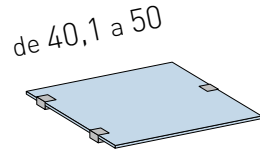
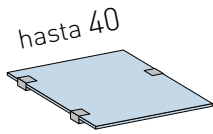

Ref.	EV44	EV54	EV64	EV84
Puntos	66	74	82	99

Grosor 0.6

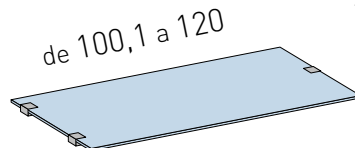
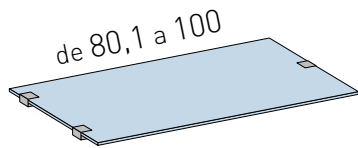

Acabados cristal
transparente y opaco

Acabados soporte
estante cristal

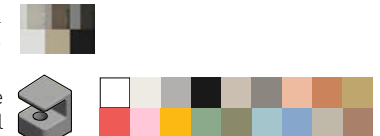

Ref.	EV104	EV124
Puntos	126	142

ZAPATERO FIJO FONDO 55

Soportes incluidos

Grosor 3

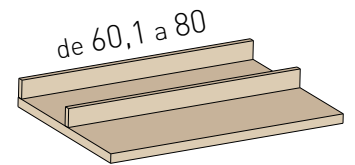
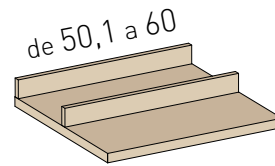
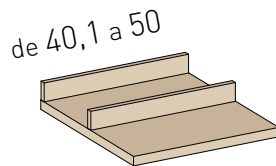
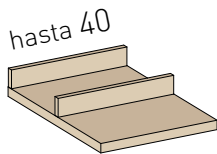

	izquierda	derecha	izquierda	derecha	izquierda	derecha	izquierda	derecha
Ref.	EZ44Z	EZ44D	EZ54Z	EZ54D	EZ64Z	EZ64D	EZ84Z	EZ84D
Puntos	49	49	53	53	57	57	62	62

Grosor 3

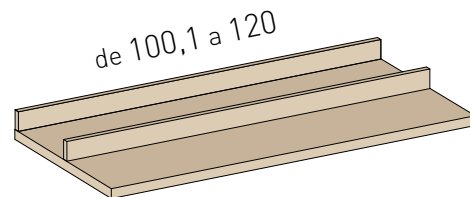
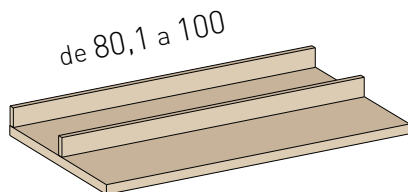

	izquierda	derecha	izquierda	derecha
Ref.	EZ104Z	EZ104D	EZ124Z	EZ124D
Puntos	65	65	71	71



No tiene mano
Soportes incluidos

ZAPATERO EXTRAÍBLE FONDO 55

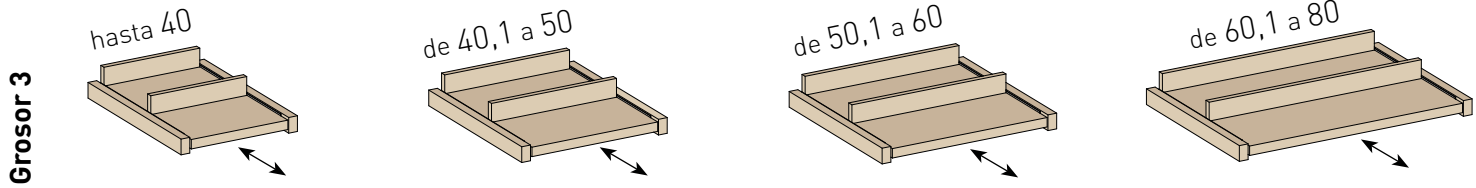

Ref.	EX44	EX54	EX64	EX84
Puntos	71	75	80	84

BARRAS

No tiene mano
Soportes incluidos

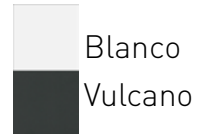

Cada barra incorpora un juego de dos soportes.

Ref.	BC45	BC56	BC68	BC100
Puntos	27	30	33	41

CAJONERAS FONDO 55

Cajoneras con los lados canteados

Costilla de 11

No tiene mano
Soportes incluidos

Altura 21,5



Ref.	CG163	CG183	CG103
Puntos	114	134	152

Altura 37



Ref.	CG263	CG283	CG203
Puntos	166	195	218

PANTALONEROS FONDO 55

No tiene mano
Soportes incluidos

Altura 18,5

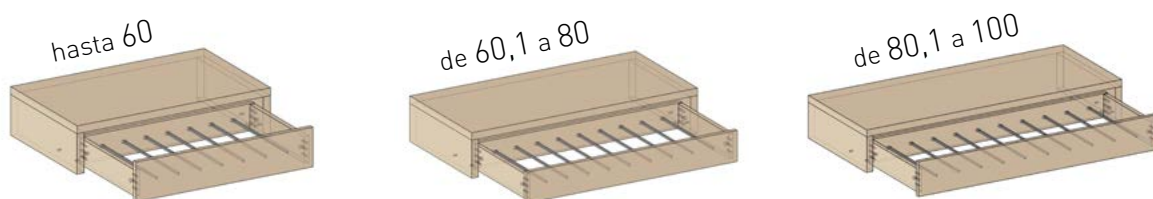

Ref.	PNT607	PNT687	PNT107
Puntos	162	182	198

OPCIONES RAIL SYSTEM

EJEMPLO ELECCIÓN DE INTERIORES

Añade una referencia de sistema de guías **por cada hueco** que desees equipar con **Rail System**

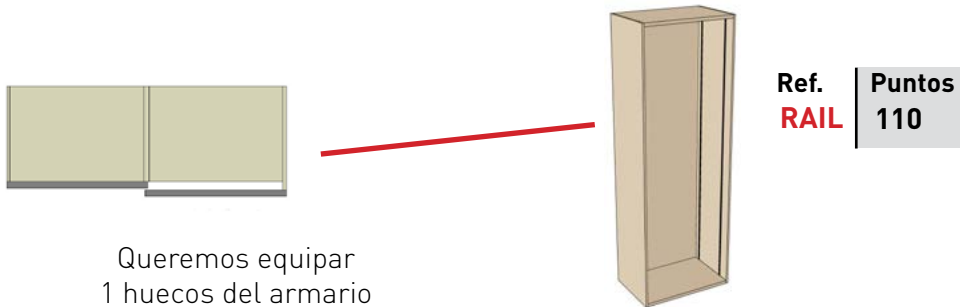

Deseamos añadir 2 estantes, una barra de colgar y una cajonera al interior de un armario de 195 cm, de 239 cm de altura.

Buscar las opciones de interior deseadas para un hueco interior de 95,5

200

Al modificar el armario de 200 a 195 las medidas de hueco son 93.

Ref.	Puntos
ET80R	48
ET80R	48
BC10R	30
CG2310R	240

de 80,1 a 100

Las opciones de interior se adaptan a la medida exacta del hueco interior.

No hay incremento en los puntos por recortar las opciones, son 110 puntos por Rail System 1 hueco + 366 puntos por interiores un total de **476 puntos**

OPCIONES PARA CORREDERAS CON RAIL SYSTEM

RAIL SYSTEM

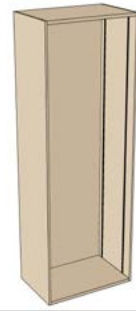

* Incluir una referencia por cuerpo

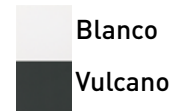

Ref.	RAIL
Puntos	110

ESTANTES FONDO 55

Grosor 3

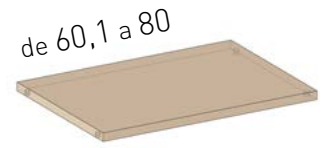
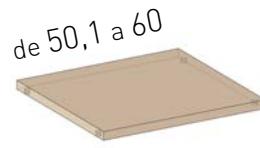
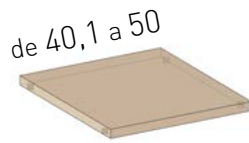

Ref.	ET84R	ET85R	ET86R	ET88R
Puntos	36	39	43	46

Grosor 3

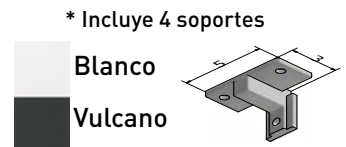
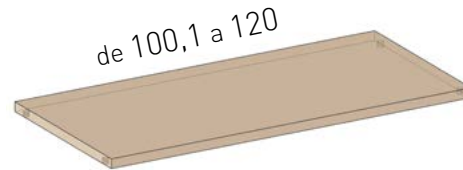
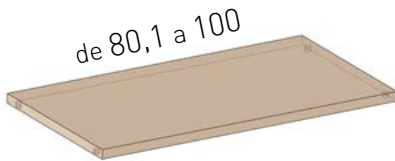

Ref.	ET80R	ET82R
Puntos	48	53

ESTANTES EXTRAIBLE FONDO 55

Grosor 3

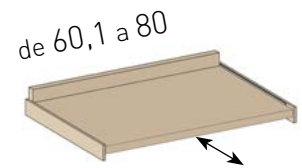
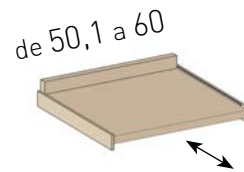
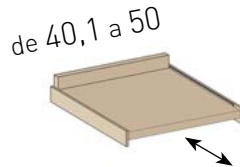
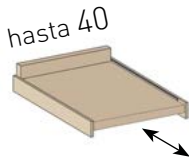

Ref.	ETT84R	ETT85R	ETT86R	ETT88R
Puntos	68	71	75	79

Grosor 3

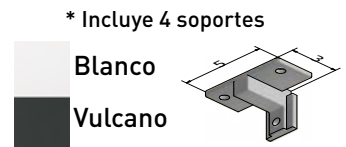
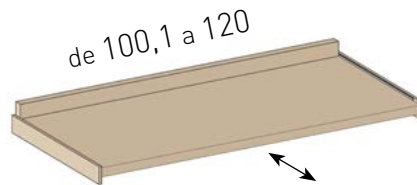
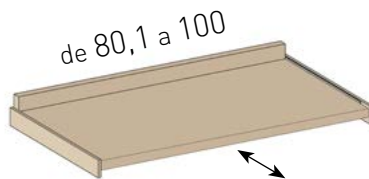

Ref.	ETT80R	ETT82R
Puntos	80	85

BARRAS

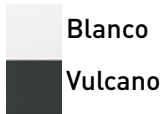

* Obligatorio un estante superior

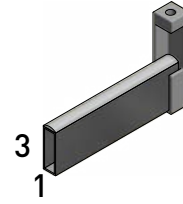
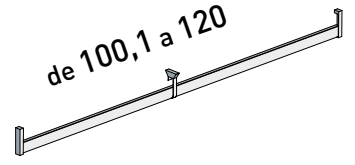
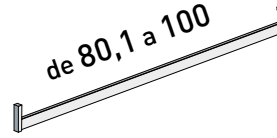
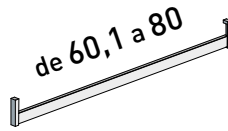
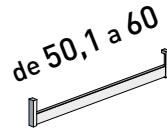
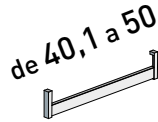
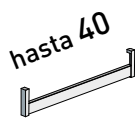

Barra rectangular con 2 soportes de fijación a estante. Perfil superior minimiza ruido.

Incorpora 3 soportes.

Ref.	BC4R	BC5R	BC6R	BC8R	BC10R	BC12R
Puntos	18	21	24	27	30	37

ESTANTES CRISTAL FONDO 55

Grosor 0,6

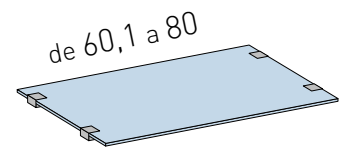
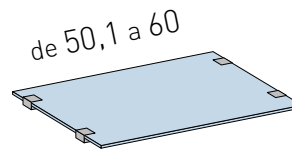
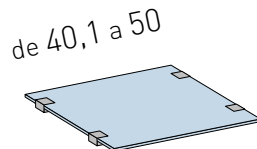
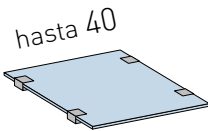

Ref.	EV43R	EV53R	EV63R	EV83R
Puntos	76	84	92	108

Grosor 0,6

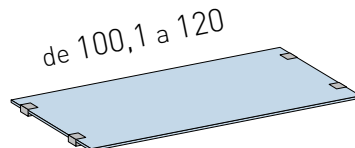
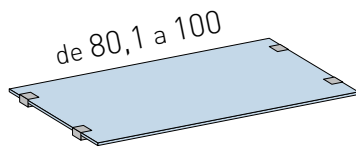

Acabados cristal transparente y opaco



Acabados soporte estante cristal



Ref.	EV103R	EV123R
Puntos	126	152

ZAPATERO FIJO FONDO 55

Grosor 3

hasta 40

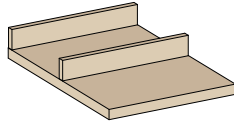

de 40,1 a 50

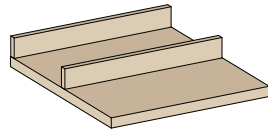

de 50,1 a 60

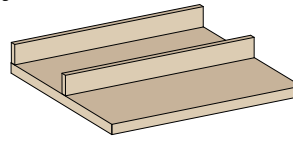

de 60,1 a 80

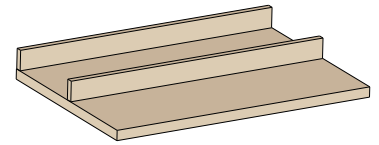

Ref.	EZ43R	EZ53R	EZ63R	EZ83R
Puntos	48	52	57	61

Grosor 3

de 80,1 a 100

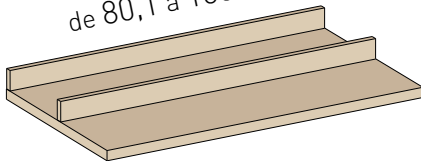

de 100,1 a 120

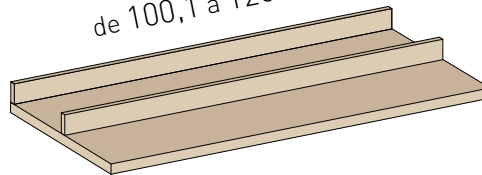

* Incluye 4 soportes

Blanco
Vulcano

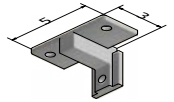

Ref.	EZ103R	EZ123R
Puntos	64	70

ZAPATERO EXTRAÍBLE FONDO 55

Grosor 3

hasta 40

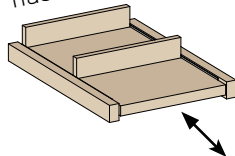

de 40,1 a 50

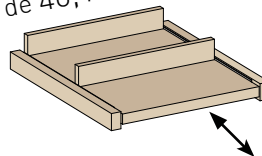

de 50,1 a 60

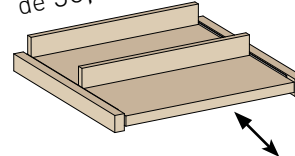

de 60,1 a 80

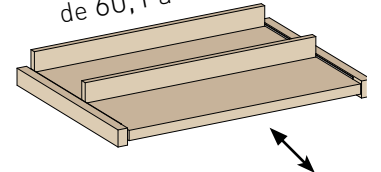

Ref.	EX43R	EX53R	EX63R	EX83R
Puntos	73	77	82	86

Grosor 3

de 80,1 a 100

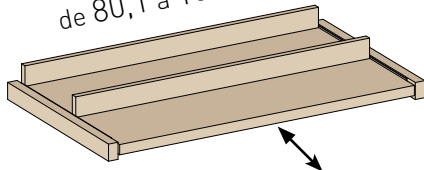

de 100,1 a 120

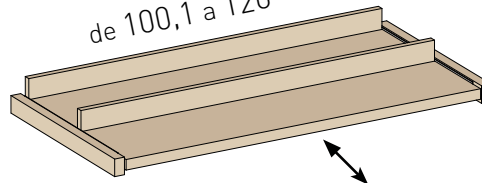

* Incluye 4 soportes

Blanco
Vulcano

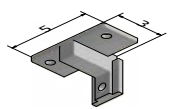

Ref.	EX103R	EX123R
Puntos	89	95

PARTIDORES FONDO 55

Grosor 3

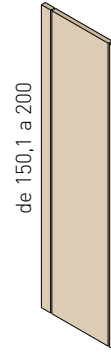
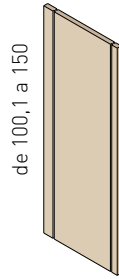
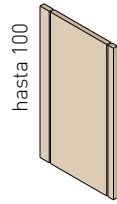

*Por defecto incluye Rail System por ambos lados.

Ref.	DNT103R	DNT153R	DNT203R	DNT303R
Puntos	94	124	163	174

PARTIDORES ALUMINIO

Blanco
Vulcano

* Compatible solo con cajoneras colgadas

Grosor 3

hasta 100



de 100,1 a 150



de 150,1 a 200



desde 200,1

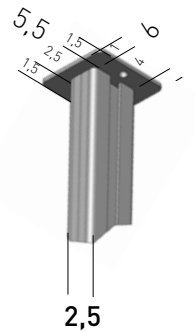

Soporte superior e inferior

Ref.	CAL10	CAL15	CAL20	CAL30
Puntos	46	52	86	96

OPCIONES

Zapatero extensible y extraíble

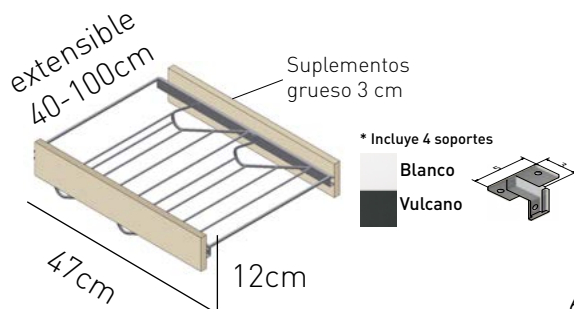

Barra abatible y extensible

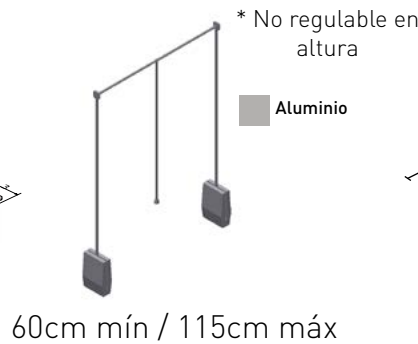

Mesa planchar plegable



Ref.	ZPR3	BRT	TPL
Puntos	105	110	168

LEDS

1 tira de led



2 tiras de leds



Ref.	LED10	LED20
Puntos	168	288

COSTILLA 11

* Incluye 4 soportes

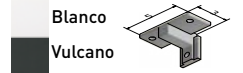

Altura 21,5

hasta 40



de 40,1 a 60



de 60,1 a 80



de 80,1 a 100



de 100,1 a 120



Ref.	CG1314R	CG1316R	CG1318R	CG1310R	CG1312R
Puntos	115	131	151	168	228

Altura 37

hasta 40



de 40,1 a 60



de 60,1 a 80



de 80,1 a 100



de 100,1 a 120



Ref.	CG2314R	CG2316R	CG2318R	CG2310R	CG2312R
Puntos	165	183	211	234	332

Altura 52,5

hasta 40



de 40,1 a 60



de 60,1 a 80



de 80,1 a 100



Ref.	CG3314R	CG3316R	CG3318R	CG3310R
Puntos	215	235	271	300

Altura 68

hasta 40



de 40,1 a 60



de 60,1 a 80



de 80,1 a 100



Ref.	CG4314R	CG4316R	CG4318R	CG4310R
Puntos	265	287	331	366

* Incluye 4 soportes



Altura 18,5

hasta 60

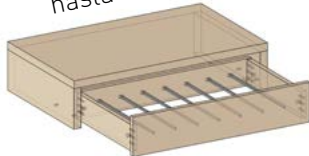

de 60,1 a 80



de 80,1 a 100

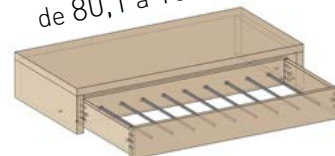

Ref.	PNT606R	PNT686R	PNT106R
Puntos	174	188	204

CAJONERAS FONDO 55

COSTILLA 16

* Incluye 4 soportes

Blanco
Vulcano

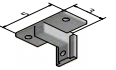

Altura 26,5

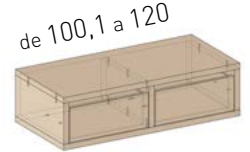

Ref.	CG1364R	CG1366R	CG1368R	CG1360R	CG1362R
Puntos	120	135	155	172	236

Altura 47

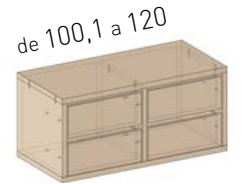

Ref.	CG2364R	CG2366R	CG2368R	CG2360R	CG2362R
Puntos	170	191	219	242	348

Altura 67,5



Ref.	CG3364R	CG3366R	CG3368R	CG3360R
Puntos	225	247	283	312

SEPARADORES CAJONES

Incremento por separadores (Cajón no incluido)

Altura 18,5

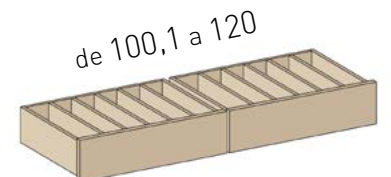
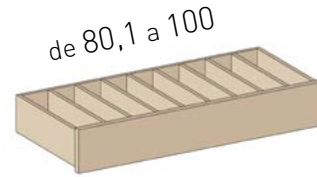
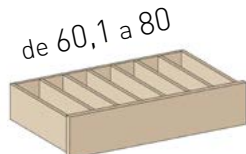
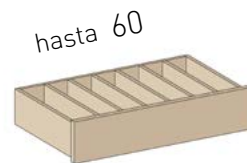

Ref.	CRB604	CRB684	CRB104	CRB124
Puntos	24	30	34	42

CASILLERO FONDO 55

* Incluye 4 soportes

Blanco
Vulcano

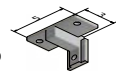

Altura 36

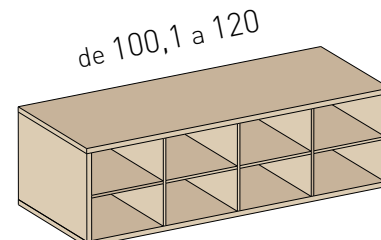
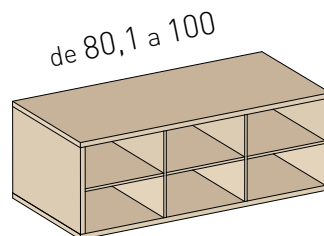
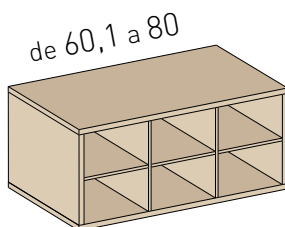

Ref.	CS82R	CS102R	CS122R
Puntos	120	144	176

Disponibles cajones de 11 y 16 cm de alto en costilla.

Ancho total de 40 a 60		Ancho total de 60,1 a 80		Ancho total de 80,1 a 100	
Altura Costilla	Altura Total	Altura Costilla	Altura Total	Altura Costilla	Altura Total
11	15,5	11	15,5	11	15,5
Ref.	CGN316R	Ref.	CGN318R	Ref.	CGN310R
Puntos	52	Puntos	60	Puntos	66
16	20,5	16	20,5	16	20,5
Ref.	CGN366R	Ref.	CGN368R	Ref.	CGN360R
Puntos	56	Puntos	64	Puntos	70

15,5
2,5
13

El precio de los lados de la cajonera va incluido en cada cajón.

Ancho total de 40 a 60	Ancho total de 60,1 a 80	Ancho total de 80,1 a 100
Ref.	Ref.	Ref.
CFN348R	CFN368R	CFN380R
Puntos	Puntos	Puntos
79	92	102

* Incluye 4 soportes

Seleccionar altura y cantidad de cajones + una tapa (obligatoria), todos del mismo ancho. Con estas referencias ya podemos crear la cajonera de libre composición.

Ejemplo de cajonera de 40 a 60:

11		CGN316R	52	+		=		3	Altura Tapa	
16		CGN366R	56						15,5	Altura Costilla 11
16		CGN366R	56						20,5	Altura Costilla 16
								20,5	Altura Costilla 16	
								3	Altura Tapa	
Puntos Total										
(52 + 56 + 56) + 79										
243										
Altura Total										
(3 + 15,5 + 20,5 + 20,5 + 3)										
62,5										

TAPETAS

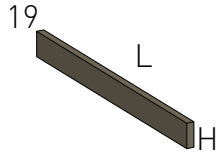

Especificar los cantos a chapar. Largos o cortos.

Precio mínimo 1 metro lineal.

sin chapar
1 canto chapado
2 cantos chapados
3 cantos chapados
4 cantos chapados

Precio metro lineal				
Acabado BASE		Acabado STONE		
L máx. 282 cm H máx. 20cm		L máx. 277 cm H máx. 20cm		
Ref.	Pts ML	Ref.	Pts ML	
8TA	8	8TS	10	
8TA1	11	8TS1	13	
8TA2	14	8TS2	16	
8TA3	17	8TS3	19	
8TA4	20	8TS4	23	

Precio mínimo 1 metro lineal.

FORROS 19

Grosor 1,9

239
61
Puntos por unidad

Acabado BASE	FR401	Acabado STONE	FS401
	54		60

260
61
Puntos por unidad

Acabado BASE	FR601	Acabado STONE	FS601
	60		66

280
61
Puntos por unidad

Acabado BASE	FR801	Acabado STONE	FS801
	66		72

FORROS 10

Grosor 1

239
61
Puntos por unidad

Acabado BASE	FR411	Acabado STONE	FS411
	41		45

260
61
Puntos por unidad

Acabado BASE	FR611	Acabado STONE	FS611
	47		52

280
61
Puntos por unidad

Acabado BASE	FR811	Acabado STONE	FS811
	53		58

Por cada color cliente que se aplique hay un mínimo 176 puntos.

En el caso de no llegar al mínimo en el conjunto de piezas del mismo color, se aplicará esta cantidad.

Puertas



Forros



Perfilería



Frente cajón

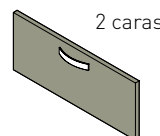

Tirador



Tapeta

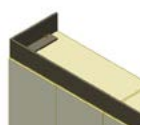

Precio metro lineal.

Ref.	altura	LAC1	altura	LAC2	altura	LAC3	LAC4	LAC5	LAC7
Puntos	120	64	120	42	120	32	15	10	12
	280	88	280	60	280	50	puntos/ud	puntos/ud	puntos/ml

INCREMENTO POR COLOR MUESTRA



CARACTERÍSTICAS TÉCNICAS ARMARIOS CORREDEROS INTERIORES

Distribución interior según diseño cliente.

Mantiene integridad superficie con taladros solo donde sean necesarios.

Puertas con tensores para asegurar un perfecto alineado.



7cm



Por defecto, para cubrir el sistema corredero interior, se incorporan 2 tapetas 1cm en la parte superior e inferior:

7cm en la parte Superior
4cm en la parte Inferior

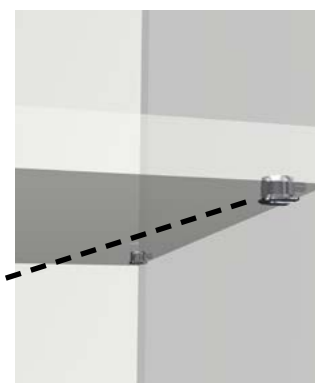

Sistema de Fijación de estantes con bloqueo seguridad y capacidad de carga

Trasera de 10mm con ranura, garantiza mayor estabilidad y firmeza. Facilita el montaje en vertical.



Costados y divisiones canteados en los 4 costados

4cm



Cajones con sistema de cierre amortiguado

Extracción total y libre configuración de altura de cajones entre 11,16 y 22cm

Regulador de altura asegura que el armario este siempre a nivel.



MATERIALES ESTRUCTURA

Costados:	Grueso de 30mm, canteados con PVC de 0.8mm, los 4 costados..
Bucs superior e inferior:	Grueso de 30mm, canteados con PVC de 0.8mm.
Divisiones interiores:	Grueso de 30mm, canteados con PVC de 0.8mm, los 4 costados.
Trasera:	Grueso de 10mm.
Estantes interiores:	Grueso de 30mm, canteados con PVC de 0.8mm, los 4 costados.

COLORES DISPONIBLES

Carta de colores
vigente de jotajotape



NUEVOS MATERIALES

Acabados STONE



Acabados STONE solo disponible en grueso 19mm y 10mm. Canteado siempre en PVC 0.8mm. Disponible para frentes, traseras, forros, tapetas y tapas.

Acabados CRISTALES



Lacados
y espejos

Cristales con cantos pulidos de 4mm de grosor para puertas y 6mm para estantes. Para los acabados lacados cristal templado y en el caso de espejos con lamina safe.

INFORMACIÓN TÉCNICA ESTRUCTURA

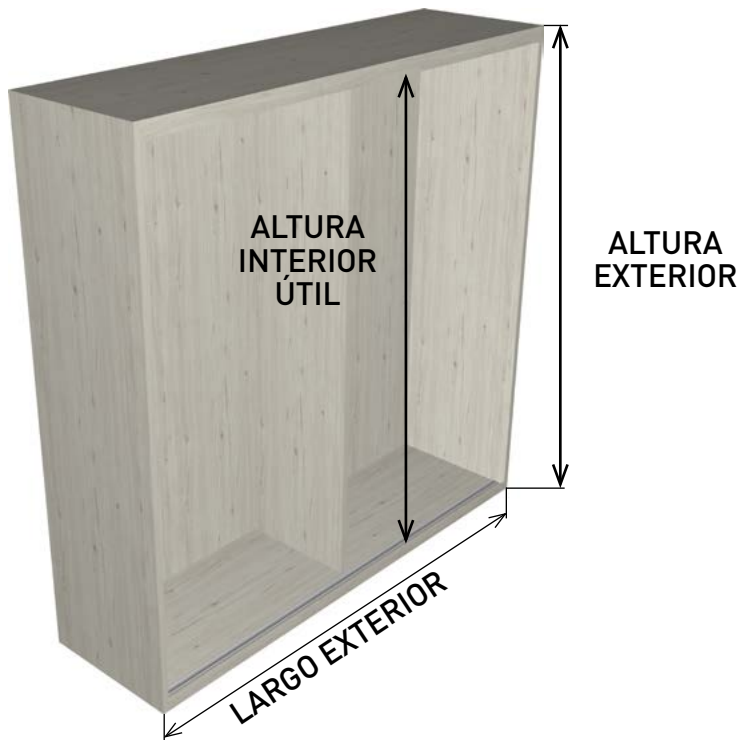

MEDIDAS A CONSIDERAR AL REALIZAR EL PEDIDO

$$\text{Altura interior útil} = \text{Altura armario} - 6\text{cm}$$

$$\text{Largo mínimo armario} = 170\text{cm}$$

Fondo mínimo armario para contener una cajonera (Caja+Puerta) = 44,5cm



MEDIDAS MÍNIMAS NECESARIAS PARA MONTAJE

$$\text{Altura hueco} = \text{Altura exterior armario} + 3\text{cm}$$

$$\text{Largo hueco} = \text{Largo exterior armario} + 5\text{cm}$$

CARACTERÍSTICAS TÉCNICAS PUERTAS CORREDERAS INTERIORES

NUEVOS MODELOS DE PUERTAS



LUX



LUX 3 PLAFONES

El catálogo **NOLIMITS NEXT** incorpora un nuevo modelo de puertas correderas interiores, el modelo **LUX**. Se presentan en dos formatos distintos, 1 plafon y 3 plafones.

Ambos modelos de puertas **LUX**, requieren de una estructura interior para instalar el sistema de carros deslizantes de las puertas.

Por este motivo no se fabrican puertas correderas interiores en acabados de cristal translúcido o transparente, ya que dejar visible esta estructura interior no tendría un acabado estético adecuado.

NUEVOS ACABADOS FRENTES



Se incorporan 5 nuevos acabados **STONE**, para dar un acento original y elegante.



Gran variedad de acabados cristal, a escoger entre lacados y espejos.

PASOS PARA CONFECCIONAR UN ARMARIO

1. Elegir caja

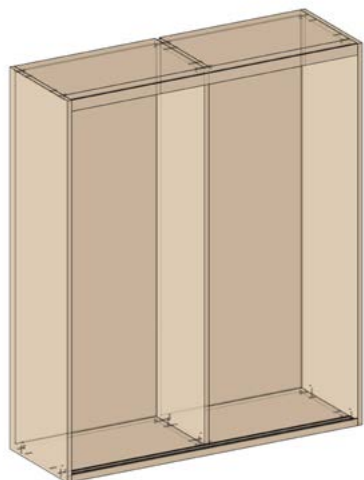

SIN DISTRIBUCIÓN INTERIOR

2. Elegir puertas



de pág. 203 a pág. 210

3. Opciones

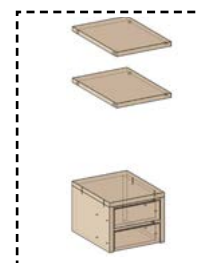

de pág. 211 a 224

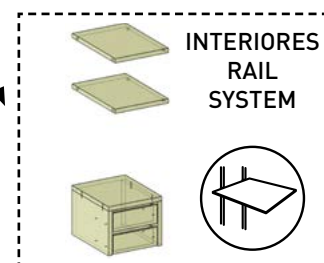

de pág. 225 a 234

IMPRESINDIBLE ENVIAR DIBUJO DE LA DISTRIBUCIÓN INTERIOR.

MEDIDAS ESPECIALES

Elegir la medida superior y cortar, sin incremento.

CAJAS ARMARIO

En todos los casos el fondo es 67,5

Para su perfecto acabado añadir tapetas pag 236

PUERTAS

Ancho mínimo de la puertas es de 83cm

MONTAJE

Para montar un armario en un hueco es necesario disponer de **5cm** libres para su montaje lateral, y de **5cm** libres para su montaje superior. Si es posible montar el armario e introducir éste en el hueco, no hace falta disponer de las distancias marcadas anteriormente.

TACO

Información importante

Regulación entre 10 y 30mm para compensar desvío de suelo. Estos 10mm se deben tener en cuenta para la altura total (no están contabilizados en las medidas de tarifa)

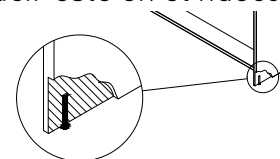

EJEMPLO ELECCIÓN DE CAJA

El cliente desea un armario de 195 cm, de 239 cm de altura

Buscar la caja superior, en este caso 200 cm, que tiene dos cuerpos y su altura correspondiente

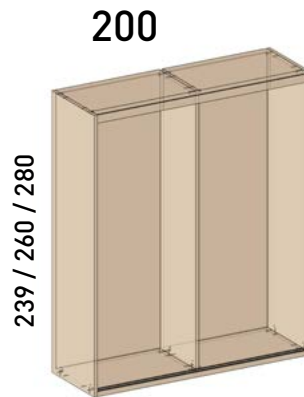

Altura	Ref.	Puntos
239	APL204	526
260	APL206	566
280	APL208	605

Que características tiene el armario y cual es su valor en puntos.

Con la referencia **APL204** tenemos un armario de 195 cm ancho y 239 cm alto.

El espacio interior que nos queda es menor que el del armario de 200 y las puertas lógicamente también quedan mas pequeñas, pero **siempre todas iguales**.

No hay incremento en los puntos por cortar el armario, por eso su valor es 526 puntos.

En resumen: Solo se tiene que elegir **APL204** a 195 cm y jotajotape se encarga del resto.

170

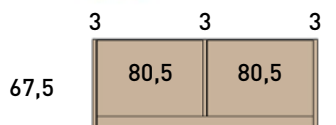
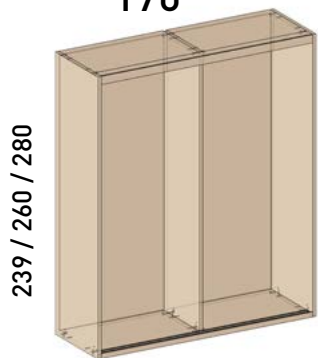

Puertas de ancho 83,3.

Con tapeta superior e inferior.

Altura	Ref.	Puntos
239	APL174	433
260	APL176	483
280	APL178	523

180

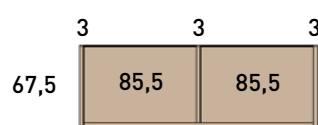
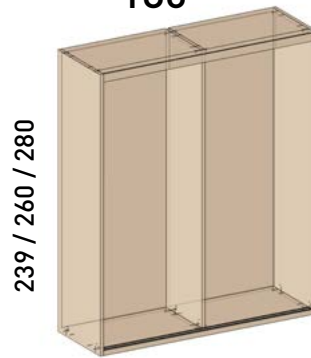

Puertas de ancho 88,3.

Con tapeta superior e inferior.

Altura	Ref.	Puntos
239	APL184	464
260	APL186	514
280	APL188	554

190

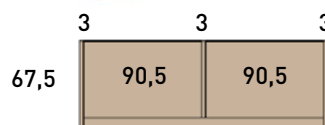
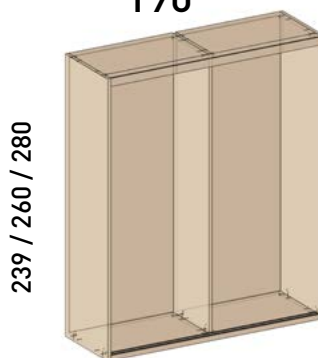

Puertas de ancho 93,3.

Con tapeta superior e inferior.

Altura	Ref.	Puntos
239	APL194	495
260	APL196	535
280	APL198	576

200

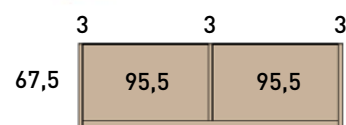
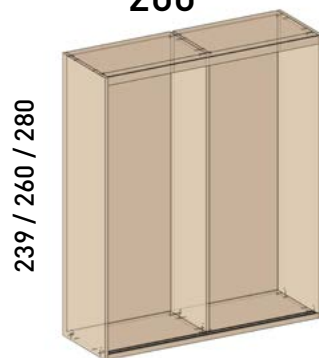

Puertas de ancho 98,3.

Con tapeta superior e inferior.

Altura	Ref.	Puntos
239	APL204	526
260	APL206	566
280	APL208	605

210

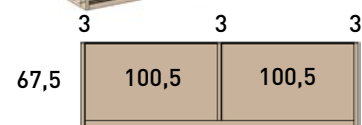

Puertas de ancho 103,3.

Con tapeta superior e inferior.

Altura	Ref.	Puntos
239	APL214	557
260	APL216	597
280	APL218	636

220

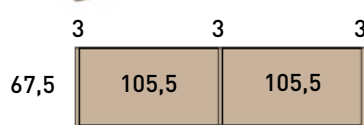
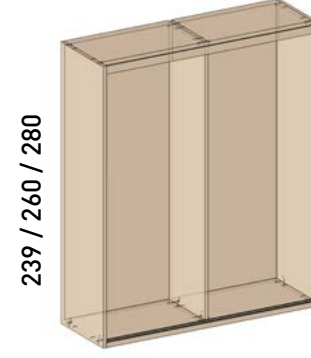

Puertas de ancho 108,3.

Con tapeta superior e inferior.

Altura	Ref.	Puntos
239	APL224	588
260	APL226	628
280	APL228	669

A partir de medidas interiores superiores a 120, no se puede introducir ni barra ni estante.
Para medidas intermedias, coger referencia de medida superior y cortar. Sin incremento por especial.

230



239 / 260 / 280

3 3 3

67,5

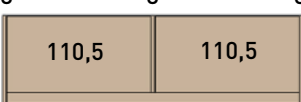

Puertas de ancho 113,3.

Con tapeta superior e inferior.

Altura	Ref.	Puntos
239	APL234	619
260	APL236	659
280	APL238	700

240



239 / 260 / 280

3 3 3

67,5

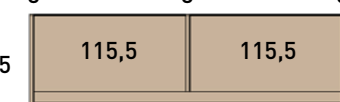

Puertas de ancho 118,3.

Con tapeta superior e inferior.

Altura	Ref.	Puntos
239	APL244	650
260	APL246	690
280	APL248	731

250



239 / 260 / 280

3 3 3

67,5

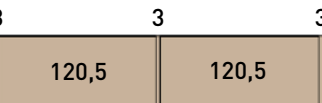

Puertas de ancho 123,3.

Con tapeta superior e inferior.

Altura	Ref.	Puntos
239	APL254	669
260	APL256	710
280	APL258	753

Precisan de divisiones para equipamiento interior.

260



239 / 260 / 280

3 3 3

67,5

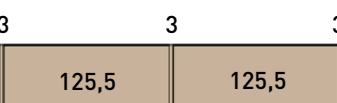

Puertas de ancho 128,3.

Con tapeta superior e inferior.

Altura	Ref.	Puntos
239	APL264	690
260	APL266	731
280	APL268	775

Precisan de divisiones para equipamiento interior.

270



239 / 260 / 280

3 3 3

67,5

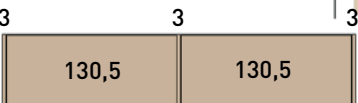

Puertas de ancho 133,3.

Con tapeta superior e inferior.

Altura	Ref.	Puntos
239	APL274	711
260	APL276	749
280	APL278	797

Precisan de divisiones para equipamiento interior.

280



239 / 260 / 280

3 3 3

67,5

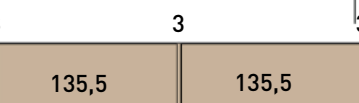

Puertas de ancho 138,3.

Con tapeta superior e inferior.

Altura	Ref.	Puntos
239	APL284	729
260	APL286	770
280	APL288	819

Precisan de divisiones para equipamiento interior.

A partir de medidas interiores superiores a 120, no se puede introducir ni barra ni estante.

Para medidas intermedias, coger referencia de medida superior y cortar. Sin incremento por especial.

290

Con tapeta superior e inferior.



Altura	Ref.	Puntos
239	APL294	752
260	APL296	792
280	APL298	839

Precisan de divisiones para equipamiento interior.

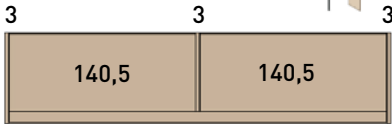

Puertas de ancho 143,3.

300

Con tapeta superior e inferior.



Altura	Ref.	Puntos
239	APL304	773
260	APL306	813
280	APL308	862

Precisan de divisiones para equipamiento interior.

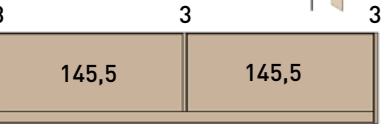

Puertas de ancho 148,3.

310

Con tapeta superior e inferior.

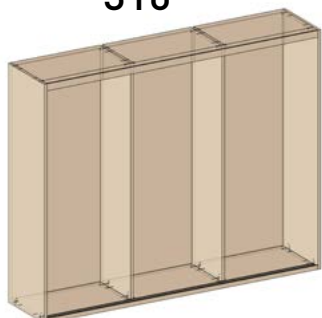

Altura	Ref.	Puntos
239	APL314	841
260	APL316	886
280	APL318	930

Precisan de divisiones para equipamiento interior.

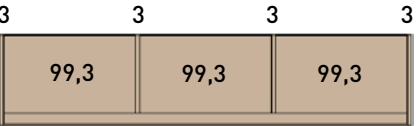

Puertas de ancho 103,1.

320

Con tapeta superior e inferior.

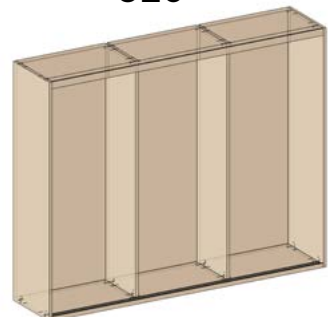

Altura	Ref.	Puntos
239	APL324	860
260	APL326	904
280	APL328	948

Precisan de divisiones para equipamiento interior.

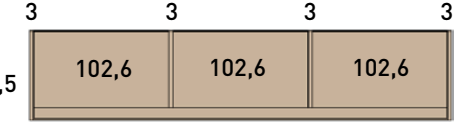

Puertas de ancho 106,4.

330

Con tapeta superior e inferior.



Altura	Ref.	Puntos
239	APL334	879
260	APL336	924
280	APL338	969

Precisan de divisiones para equipamiento interior.

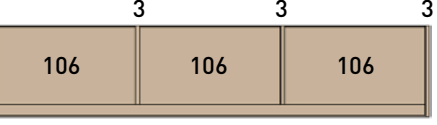

Puertas de ancho 109,7.

340

Con tapeta superior e inferior.

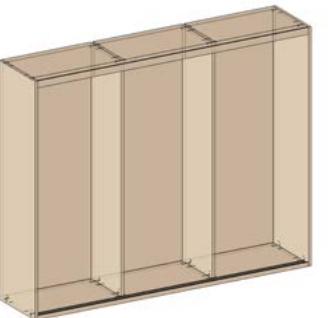

Altura	Ref.	Puntos
239	APL344	898
260	APL346	944
280	APL348	991

Precisan de divisiones para equipamiento interior.

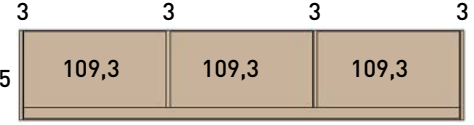

Puertas de ancho 113,1.

A partir de medidas interiores superiores a 120, no se puede introducir ni barra ni estante.
 Para medidas intermedias, coger referencia de medida superior y cortar. Sin incremento por especial.

Con tapeta superior e inferior.

350

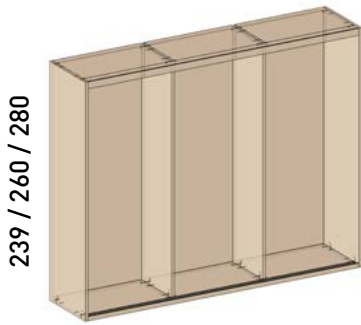

239 / 260 / 280

Altura	Ref.	Puntos
239	APL354	917
260	APL356	963
280	APL358	1008

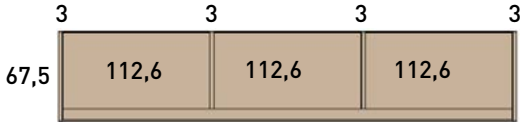

Puertas de ancho 116,4.

Con tapeta superior e inferior.

360

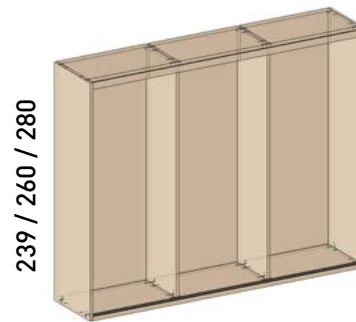

239 / 260 / 280

Altura	Ref.	Puntos
239	APL364	936
260	APL366	982
280	APL368	1028

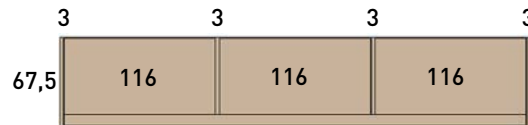

Puertas de ancho 119,7.

Con tapeta superior e inferior.

370

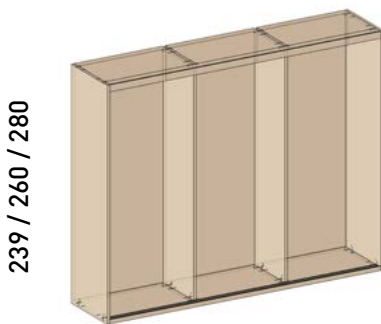

239 / 260 / 280

Altura	Ref.	Puntos
239	APL374	959
260	APL376	1008
280	APL378	1054

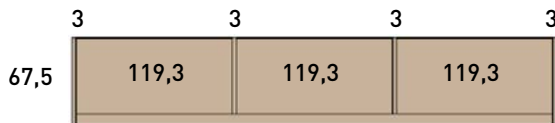

Puertas de ancho 123,1.

Con tapeta superior e inferior.

380

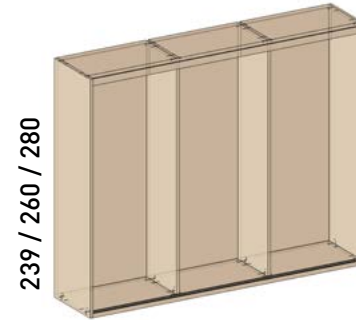

239 / 260 / 280

Altura	Ref.	Puntos
239	APL384	982
260	APL386	1034
280	APL388	1080

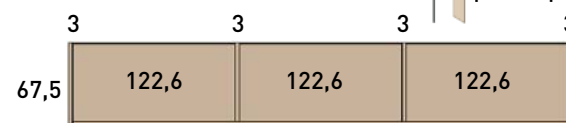

Puertas de ancho 126,4.

Precisan de divisiones para equipamiento interior.

Con tapeta superior e inferior.

390

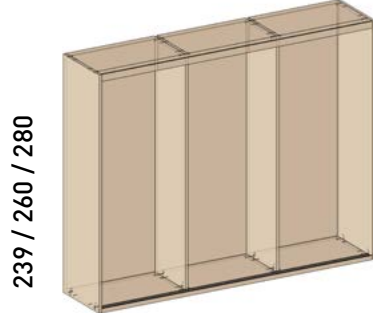

239 / 260 / 280

Altura	Ref.	Puntos
239	APL394	1005
260	APL396	1060
280	APL398	1106

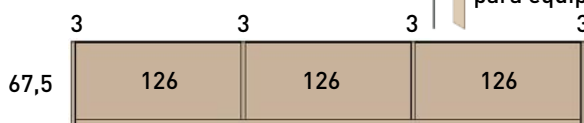

Puertas de ancho 129,7.

Precisan de divisiones para equipamiento interior.

Con tapeta superior e inferior.

400

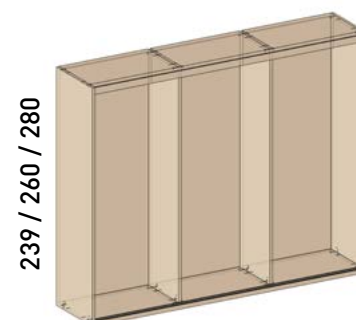

239 / 260 / 280

Altura	Ref.	Puntos
239	APL404	1028
260	APL406	1086
280	APL408	1132

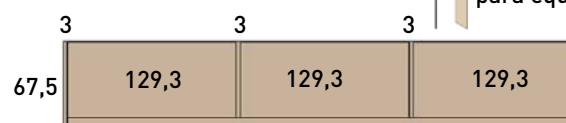

Puertas de ancho 133,1.

Precisan de divisiones para equipamiento interior.

A partir de medidas interiores superiores a 120, no se puede introducir ni barra ni estante.
Para medidas intermedias, coger referencia de medida superior y cortar. Sin incremento por especial.

Con tapeta superior e inferior.

Con tapeta superior e inferior.

410

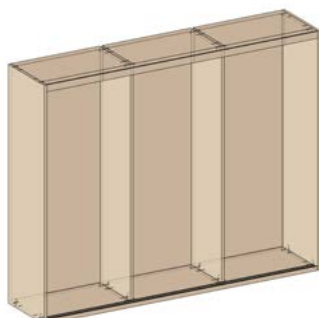

Altura	Ref.	Puntos
239	APL414	1051
260	APL416	1112
280	APL418	1158

Precisan de divisiones para equipamiento interior.

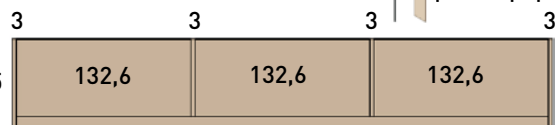

Puertas de ancho 136,4.

420

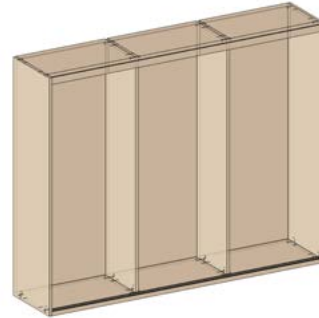

Altura	Ref.	Puntos
239	APL424	1074
260	APL426	1138
280	APL428	1184

Precisan de divisiones para equipamiento interior.

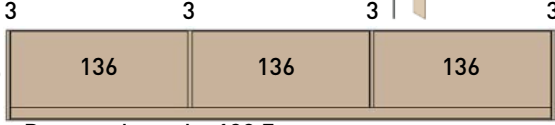

Puertas de ancho 139,7.

Con tapeta superior e inferior.

Con tapeta superior e inferior.

430

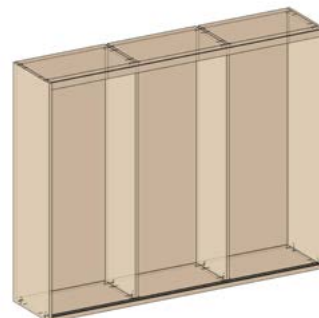

Altura	Ref.	Puntos
239	APL434	1097
260	APL436	1164
280	APL438	1210

Precisan de divisiones para equipamiento interior.

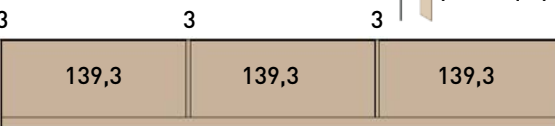

Puertas de ancho 143,1.

440

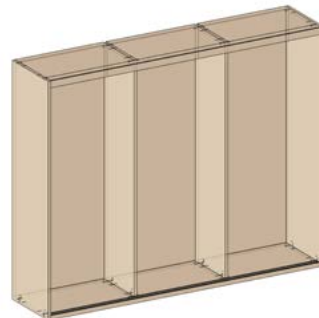

Altura	Ref.	Puntos
239	APL444	1120
260	APL446	1190
280	APL448	1236

Precisan de divisiones para equipamiento interior.

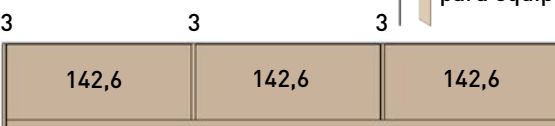

Puertas de ancho 146,4.

Con tapeta superior e inferior.

Con tapeta superior e inferior.

450

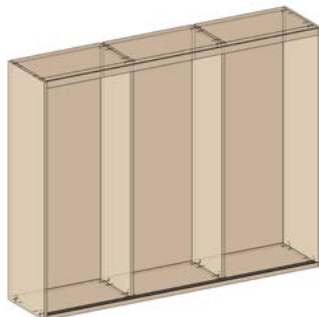

Altura	Ref.	Puntos
239	APL454	1144
260	APL456	1214
280	APL458	1259

Precisan de divisiones para equipamiento interior.

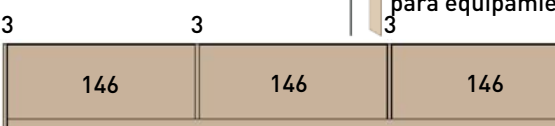

Puertas de ancho 127,2.

460

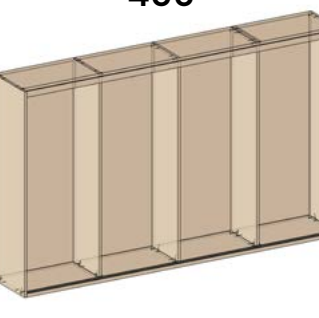

Altura	Ref.	Puntos
239	APL464	1204
260	APL466	1264
280	APL468	1319

Precisan de divisiones para equipamiento interior.

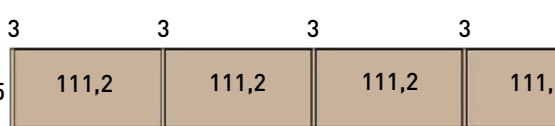

Puertas de ancho 114,7.

A partir de medidas interiores superiores a 120, no se puede introducir ni barra ni estante.
 Para medidas intermedias, coger referencia de medida superior y cortar. Sin incremento por especial.

Con tapeta superior e inferior.

470

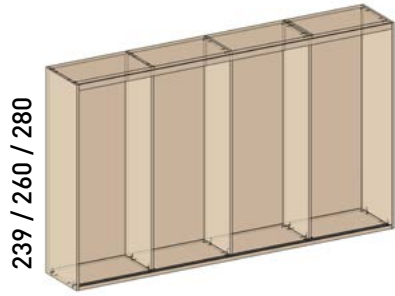

Altura	Ref.	Puntos
239	APL474	1228
260	APL476	1289
280	APL478	1345

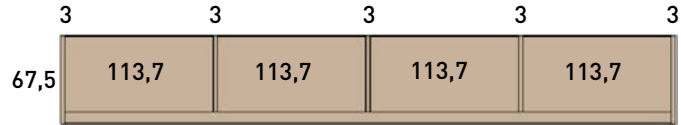

Puertas de ancho 117,2.

Con tapeta superior e inferior.

480

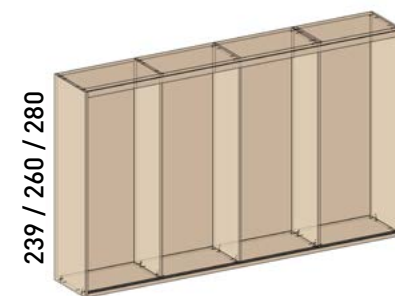

Altura	Ref.	Puntos
239	APL484	1252
260	APL486	1313
280	APL488	1370

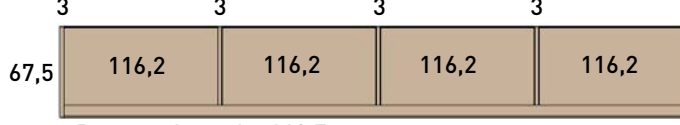

Puertas de ancho 119,7.

Con tapeta superior e inferior.

490

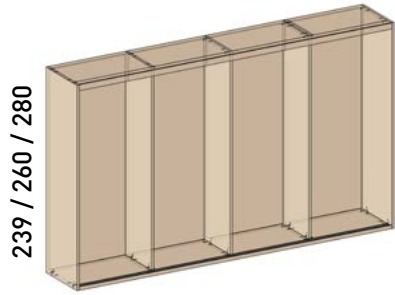

Altura	Ref.	Puntos
239	APL494	1274
260	APL496	1335
280	APL498	1389

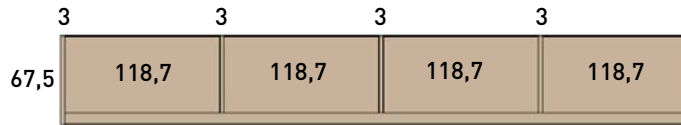

Puertas de ancho 122,2.

Con tapeta superior e inferior.

500

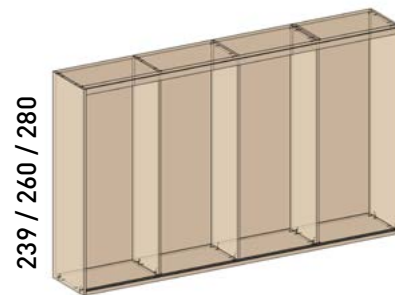

Altura	Ref.	Puntos
239	APL504	1296
260	APL506	1357
280	APL508	1408

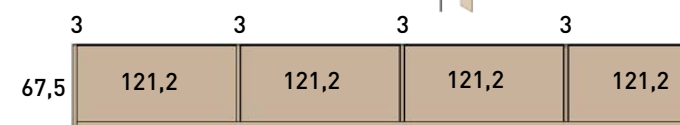

Precisan de divisiones para equipamiento interior.

Puertas de ancho 124,7.

Con tapeta superior e inferior.

510

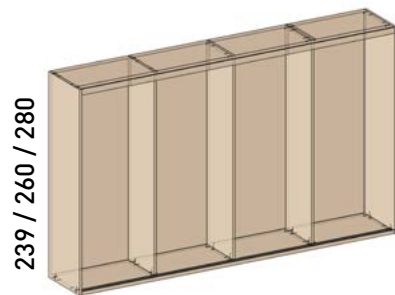

Altura	Ref.	Puntos
239	APL514	1318
260	APL516	1379
280	APL518	1427

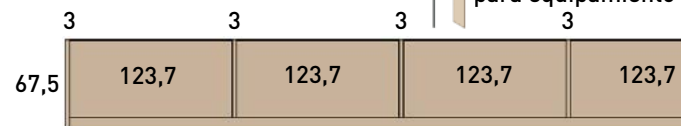

Precisan de divisiones para equipamiento interior.

Puertas de ancho 127,2.

Con tapeta superior e inferior.

520

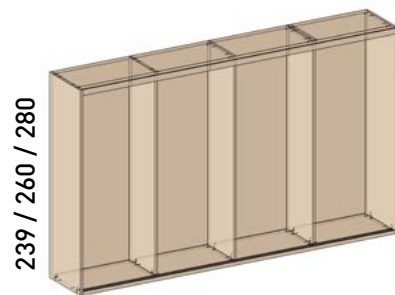

Altura	Ref.	Puntos
239	APL524	1340
260	APL526	1401
280	APL528	1446

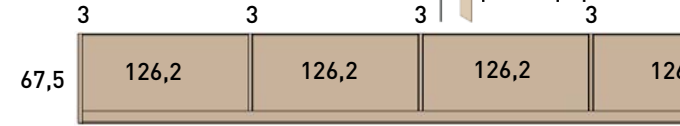

Precisan de divisiones para equipamiento interior.

Puertas de ancho 129,7.

A partir de medidas interiores superiores a 120, no se puede introducir ni barra ni estante.

Para medidas intermedias, coger referencia de medida superior y cortar. Sin incremento por especial.

Con tapeta superior e inferior.

530

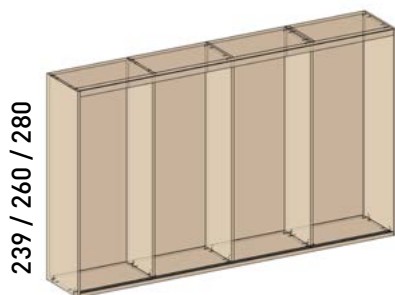

Altura	Ref.	Puntos
239	APL534	1362
260	APL536	1423
280	APL538	1465

Precisan de divisiones para equipamiento interior.

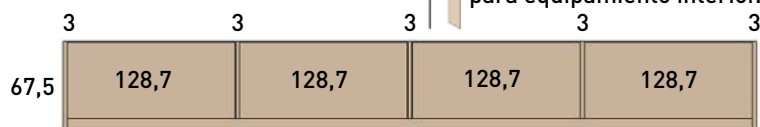

Puertas de ancho 132,2.

Con tapeta superior e inferior.

540

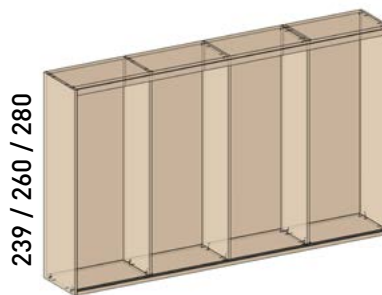

Altura	Ref.	Puntos
239	APL544	1384
260	APL546	1445
280	APL548	1484

Precisan de divisiones para equipamiento interior.

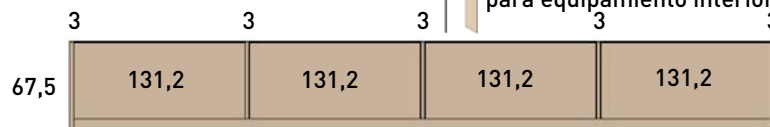

Puertas de ancho 134,7.

Con tapeta superior e inferior.

550

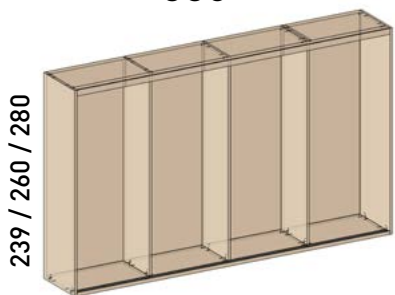

Altura	Ref.	Puntos
239	APL554	1406
260	APL556	1467
280	APL558	1503

Precisan de divisiones para equipamiento interior.

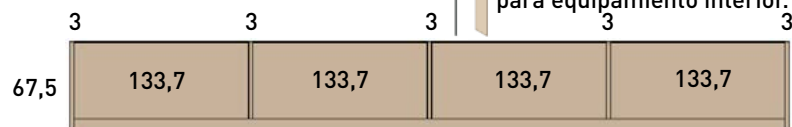

Puertas de ancho 137,2.

Con tapeta superior e inferior.

560

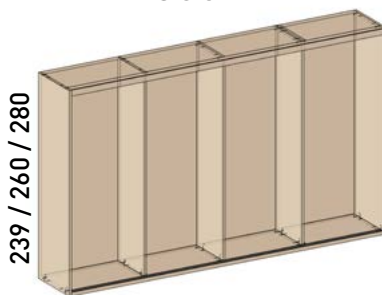

Altura	Ref.	Puntos
239	APL564	1428
260	APL566	1489
280	APL568	1522

Precisan de divisiones para equipamiento interior.

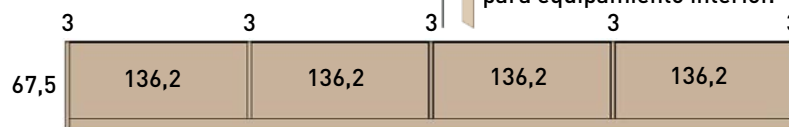

Puertas de ancho 139,7.

Con tapeta superior e inferior.

570

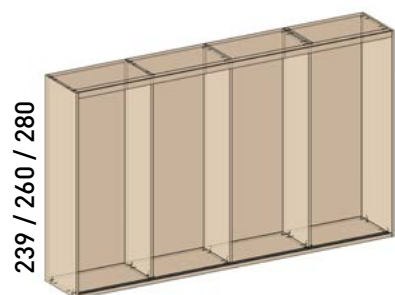

Altura	Ref.	Puntos
239	APL574	1450
260	APL576	1511
280	APL578	1541

Precisan de divisiones para equipamiento interior.

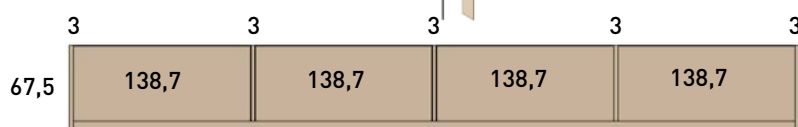

Puertas de ancho 142,2.

Con tapeta superior e inferior.

580

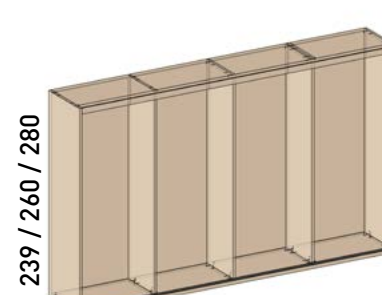

Altura	Ref.	Puntos
239	APL584	1472
260	APL586	1533
280	APL588	1560

Precisan de divisiones para equipamiento interior.

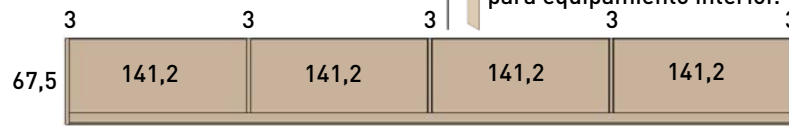

Puertas de ancho 144,7.

A partir de medidas interiores superiores a 120, no se puede introducir ni barra ni estante.

Para medidas intermedias, coger referencia de medida superior y cortar. Sin incremento por especial.

Con tapeta superior e inferior.

590

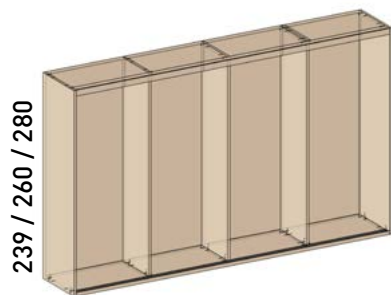

Altura	Ref.	Puntos
239	APL594	1494
260	APL596	1555
280	APL598	1579

Precisan de divisiones para equipamiento interior.

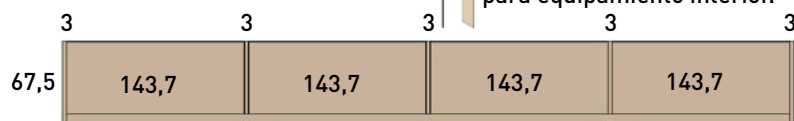

Puertas de ancho 147,2.

Con tapeta superior e inferior.

600

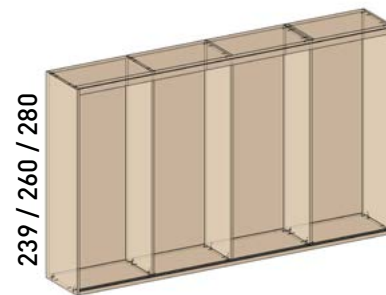

Altura	Ref.	Puntos
239	APL604	1516
260	APL606	1577
280	APL608	1598

Precisan de divisiones para equipamiento interior.

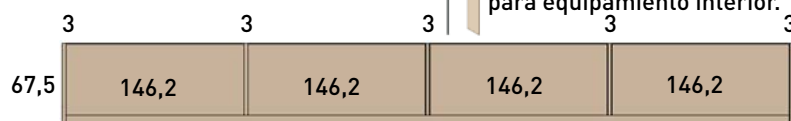

Puertas de ancho 149,7.

A partir de medidas interiores superiores a 120, no se puede introducir ni barra ni estante.
Para medidas intermedias, coger referencia de medida superior y cortar. Sin incremento por especial.

EJEMPLO ELECCION DE PUERTAS

El cliente desea 2 puertas para un armario de 195 cm, de 239 cm de altura

Buscar las puertas deseadas, en este caso elegimos la de 1 plafón, con sus colores, su altura y el rango de medida.

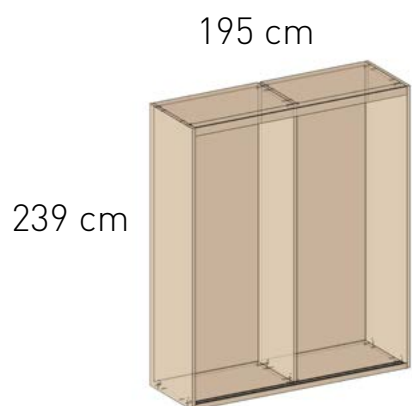

Puertas para armario de 2 cuerpos



	Altura	Acabados BASE		Acabados STONE	
		Ref	Puntos	Ref	Puntos
Puerta ancho de 83 a 110	239	PL14	252	PLS14	269
	260	PL16	275	PLS16	295
	280	PL18	291	PLS18	314
Puerta ancho de 110,1 a 150	239	PL24	281	PLS24	303
	260	PL26	307	PLS26	331
	280	PL28	323	PLS28	351
Acabados					

Tenemos 2 referencias (una por cuerpo): **PL14** x 2 todas iguales adaptadas al armario de 195.

No hay incremento en los puntos por modificar las puertas, por eso nos quedan **504 puntos** (las 2 puertas).

1 PLAFÓN



Acabados puerta



Acabados perfil



Estas puertas no tienen mano.
Pueden ir tanto exterior como interior (por luz dentro de la caja del armario).

	Altura	Acabados BASE		Acabados STONE	
		Ref	Puntos	Ref	Puntos
Puerta ancho de 83 a 110	239	PL14	252	PLS14	269
	260	PL16	275	PLS16	295
	280	PL18	291	PLS18	314
Puerta ancho de 110,1 a 150	239	PL24	281	PLS24	303
	260	PL26	307	PLS26	331
	280	PL28	323	PLS28	351
Acabados					

RÚSTICA



Acabados puerta



Acabados perfil



*Indica el color de la ranura.

Incremento de 14 puntos por ranura extra.



Estas puertas no tienen mano.
Pueden ir tanto exterior como interior (por luz dentro de la caja del armario).

	Altura	Acabados BASE		Acabados STONE		
		Ref	Puntos	Ref	Puntos	
Puerta ancho de 83 a 110	239	PL94	308	PLS94	325	4 ranuras por puerta.
	260	PL96	331	PLS96	351	
	280	PL98	347	PLS98	370	
Puerta ancho de 110,1 a 150	239	PL104	365	PLS104	387	6 ranuras por puerta.
	260	PL106	391	PLS106	415	
	280	PL108	407	PLS108	435	
Acabados						

3 PLAFONES IGUALES



Acabados puerta



Acabados perfil



Estas puertas no tienen mano.
Pueden ir tanto exterior como interior (por luz dentro de la caja del armario).

	Altura	Acabados BASE		Acabados STONE	
		Ref	Puntos	Ref	Puntos
Puerta ancho de 83 a 110	239	PL34	277	PLS34	294
	260	PL36	302	PLS36	322
	280	PL38	321	PLS38	344
Puerta ancho de 110,1 a 150	239	PL44	310	PLS44	332
	260	PL46	338	PLS46	362
	280	PL48	356	PLS48	384
Acabados					

3 PLAFONES COMBINABLES



Acabados puerta y paneles



Acabados perfil

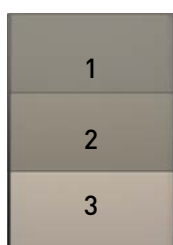

Estas puertas no tienen mano.
Pueden ir tanto exterior como interior (por luz dentro de la caja del armario).

	Altura	Acabados BASE	
		Ref	Puntos
Puerta ancho de 83 a 110	239	PL54	300
	260	PL56	323
	280	PL58	338
Puerta ancho de 110,1 a 150	239	PL64	334
	260	PL66	364
	280	PL68	383
Acabados			

LUX 1 PLAFÓN

Combinar solo con puertas enmarcadas modelo LUX



Acabados perfil



Estas puertas no tienen mano.
Pueden ir tanto exterior como interior
(por luz dentro de la caja del armario).

	Altura	Acabados CRISTAL		Acabados BASE		Acabados STONE	
		Ref	Puntos	Ref	Puntos	Ref	Puntos
Puerta ancho de 83 a 110	239	PLV134	496	PL134	332	PLS134	349
	260	PLV136	526	PL136	355	PLS136	375
	280	PLV138	556	PL138	371	PLS138	394
Puerta ancho de 110,1 a 150	239	PLV144	651	PL144	361	PLS144	383
	260	PLV146	686	PL146	387	PLS146	411
	280	PLV148	716	PL148	403	PLS148	431
Acabados		Lacados y espejos					

LUX 3 PLAFONES

Combinar solo con puertas enmarcadas modelo LUX



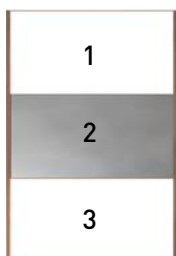

Acabados perfil



Estas puertas no tienen mano. Pueden ir tanto exterior como interior (por luz dentro de la caja del armario).

Para combinar diferentes materiales en la misma puerta consultar con fábrica.

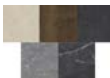
	Altura	Acabados CRISTAL		Acabados BASE		Acabados STONE	
		Ref	Puntos	Ref	Puntos	Ref	Puntos
Puerta ancho de 83 a 110	239	PLV154	501	PL154	362	PLS154	384
	260	PLV156	561	PL156	390	PLS156	410
	280	PLV158	591	PL158	406	PLS158	429
Puerta ancho de 110,1 a 150	239	PLV164	691	PL164	401	PLS164	423
	260	PLV166	726	PL166	427	PLS166	451
	280	PLV168	756	PL168	443	PLS168	471
Acabados			Lacados y espejos				

EJEMPLO ELECCIÓN DE INTERIORES

Deseamos añadir 2 estantes, una barra de colgar y una cajonera al interior de un armario de 195 cm, de 239 cm de altura.

Buscar las opciones de interior deseadas para un hueco interior de 93.

Al modificar el armario de 200 a 195 las medidas de hueco son 93.





Ref.	Puntos
ET80	34
ET80	34
BC10	28
CG3310	276

Las opciones de interior se adaptan a la medida exacta del hueco interior.

No hay incremento en los puntos por recortar las opciones, son un total de **372 puntos**.





INTERIORES PARA ARMARIOS CORREDERAS INTERIORES

ESTANTES FONDO 55

Grosor 3	hasta 40	de 40,1 a 50	de 50,1 a 60	de 60,1 a 80
				
Ref.	ET84	ET85	ET86	ET88
Puntos	22	25	29	32

Grosor 3	de 80,1 a 100	de 100,1 a 120
		
Ref.	ET80	ET82
Puntos	34	39

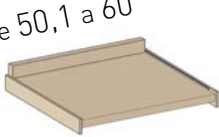
ESTANTES EXTRAIBLES FONDO 55



Grosor 3	hasta 40	de 40,1 a 50	de 50,1 a 60	de 60,1 a 80
				
Ref.	ETT84	ETT85	ETT86	ETT88
Puntos	54	57	61	64

Grosor 3	de 80,1 a 100	de 100,1 a 120
		
Ref.	ETT80	ETT82
Puntos	66	71

BARRAS

Blanco
Vulcano

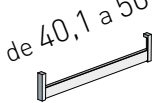

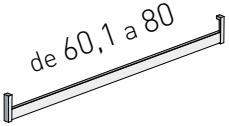
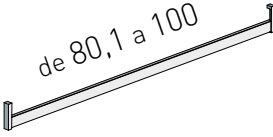
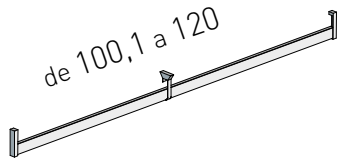
Ref.	hasta 40	de 40,1 a 50	de 50,1 a 60	de 60,1 a 80	de 80,1 a 100	de 100,1 a 120
						
Puntos	16	19	22	25	28	35

Incorpora 3 soportes.

ESTANTES CRISTAL FONDO 55

Grosor 0.6

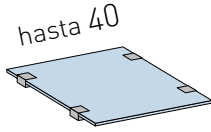

hasta 40

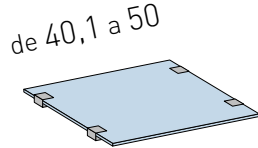

de 40,1 a 50

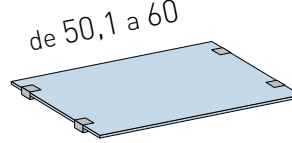

de 50,1 a 60

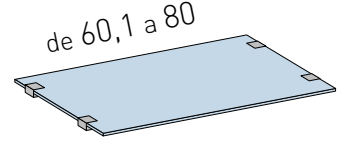

de 60,1 a 80

Ref.	EV43	EV53	EV63	EV83
Puntos	54	62	70	87

Grosor 0.6

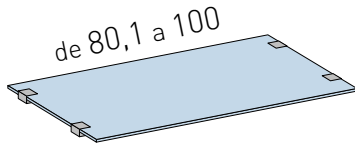

de 80,1 a 100

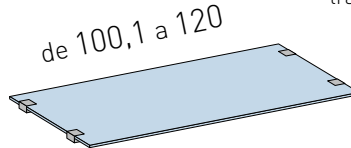

de 100,1 a 120

Acabados cristal transparente y opaco



Acabados soporte estante cristal



Ref.	EV103	EV123
Puntos	114	130

OPCIONES

Zapatero extensible y extraíble

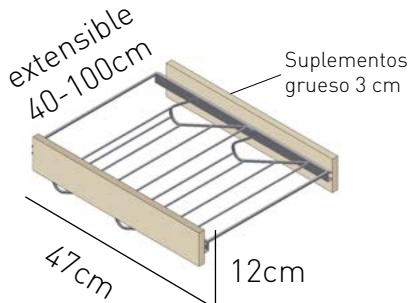

Barra abatible y extensible



Mesa planchar plegable

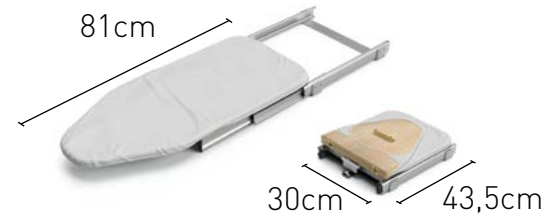

Precisa de un estante de soporte.

Ref.	ZPR	BRT	TPL
Puntos	100	110	168

*Sensor movimiento incorporado

LEDS

1 tira de led



2 tiras de leds



Ref.	LED10	LED20
Puntos	168	288

ZAPATERO FIJO FONDO 55

Grosor 3

hasta 40

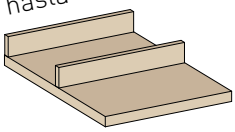

de 40,1 a 50

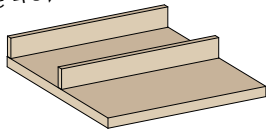

de 50,1 a 60

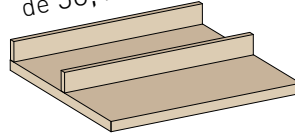

de 60,1 a 80

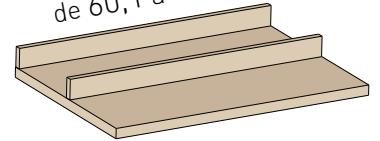

Ref.	EZ43	EZ53	EZ63	EZ83
Puntos	34	38	43	47

Grosor 3

de 80,1 a 100

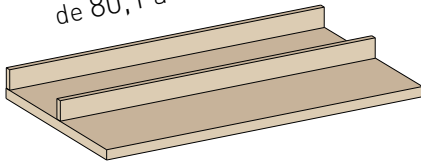

de 100,1 a 120

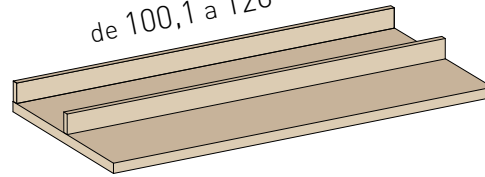

Ref.	EZ103	EZ123
Puntos	50	56

ZAPATERO EXTRAÍBLE FONDO 55

Grosor 3

hasta 40

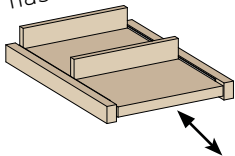

de 40,1 a 50

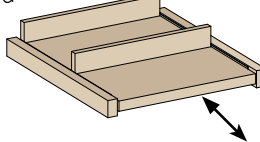

de 50,1 a 60

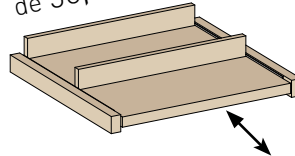

de 60,1 a 80

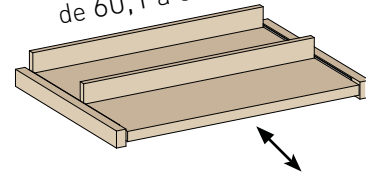

Ref.	EX43	EX53	EX63	EX83
Puntos	59	63	68	72

Grosor 3

de 80,1 a 100

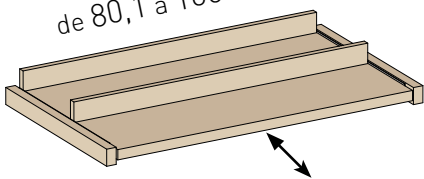

de 100,1 a 120

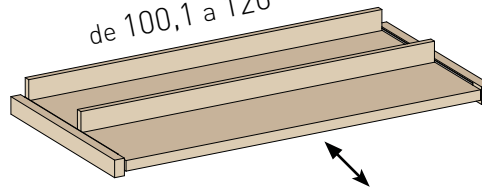

Ref.	EX103	EX123
Puntos	75	81

ZAPATERO INCLINADO FONDO 55

* Medidas especiales de fondo consultar con fábrica

Grosor 3

hasta 40

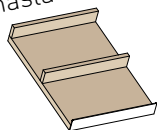

de 40,1 a 50

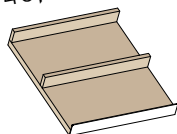

de 50,1 a 60

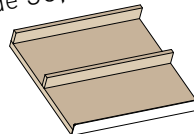

de 60,1 a 80

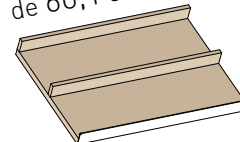

Ref.	EN43	EN53	EN63	EN83
Puntos	40	44	49	53

Grosor 3

de 80,1 a 100

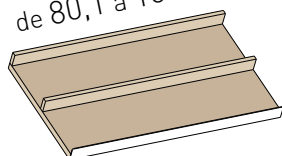

de 100,1 a 120

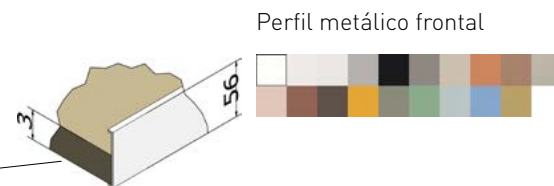
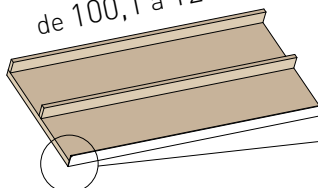

Perfil metálico frontal

Ref.	EN103	EN123
Puntos	56	62

PARTIDORES FONDO 55

Grosor 3

hasta 100



de 100,1 a 150



de 150,1 a 200



desde 200,1



Ref.	DNT103	DNT153	DNT203	DNT303
Puntos	49	54	58	64

COSTILLA 11

Altura 21,5

hasta 60



de 60,1 a 80



de 80,1 a 100



de 100,1 a 120



Ref.	CG1316	CG1318	CG1310	CG1312
Puntos	107	127	144	204

Altura 37

hasta 60



de 60,1 a 80



de 80,1 a 100



de 100,1 a 120



Ref.	CG2316	CG2318	CG2310	CG2312
Puntos	159	187	210	308

Altura 52,5

hasta 60



de 60,1 a 80



de 80,1 a 100



de 100,1 a 120



Ref.	CG3316	CG3318	CG3310	CG3312
Puntos	211	247	276	411

Altura 68

hasta 60



de 60,1 a 80



de 80,1 a 100



de 100,1 a 120



Ref.	CG4316	CG4318	CG4310	CG4312
Puntos	263	307	342	516

Altura 83,5

hasta 60



de 60,1 a 80



de 80,1 a 100



de 100,1 a 120



Ref.	CG5316	CG5318	CG5310	CG5312
Puntos	315	367	408	620

Altura 99

hasta 60



de 60,1 a 80



de 80,1 a 100



de 100,1 a 120



Ref.	CG6316	CG6318	CG6310	CG6312
Puntos	367	427	474	724

COSTILLA 16

Altura 26,5

hasta 60



de 60,1 a 80



de 80,1 a 100



de 100,1 a 120



Ref.	CG1366	CG1368	CG1360	CG1362
Puntos	111	131	148	212

Altura 47

hasta 60



de 60,1 a 80



de 80,1 a 100



de 100,1 a 120



Ref.	CG2366	CG2368	CG2360	CG2362
Puntos	167	195	218	324

Altura 67,5

hasta 60



de 60,1 a 80



de 80,1 a 100



de 100,1 a 120



Ref.	CG3366	CG3368	CG3360	CG3362
Puntos	223	259	288	436

Altura 88

hasta 60



de 60,1 a 80



de 80,1 a 100



de 100,1 a 120



Ref.	CG4366	CG4368	CG4360	CG4362
Puntos	279	323	358	548

Altura 108,5

hasta 60



de 60,1 a 80



de 80,1 a 100



de 100,1 a 120



Ref.	CG5366	CG5368	CG5360	CG5362
Puntos	335	387	428	660

CAJONERAS PARA COLGAR FONDO 55

COSTILLA 11				COSTILLA 16			
Altura 18,5	hasta 60	de 60,1 a 80	de 80,1 a 100	hasta a 60	de 60,1 a 80	de 80,1 a 100	
Ref.	CG156C	CG158C	CG150C	CG166C	CG168C	CG160C	
Puntos	87	101	112	90	104	115	
Altura 34	hasta 60	de 60,1 a 80	de 80,1 a 100	hasta 60	de 60,1 a 80	de 80,1 a 100	
Ref.	CG256C	CG258C	CG250C	CG266C	CG268C	CG260C	
Puntos	137	158	174	143	164	180	

SEPARADORES PARA CAJONES

Incremento por separadores (Cajón no incluido)

Altura 18,5	hasta 80	de 80,1 a 100	de 100,1 a 120
Ref.	CRB685	CRB105	CRB125
Puntos	30	34	42

CASILLERO FONDO 55

Altura 36	de 60,1 a 80	de 80,1 a 100	de 100,1 a 120
Ref.	CS82	CS102	CS122
Puntos	96	120	152

PANTALONEROS FONDO 55

Altura 18,5	hasta 60	de 60,1 a 80	de 80,1 a 100
Ref.	PNT606	PNT686	PNT106
Puntos	150	164	180

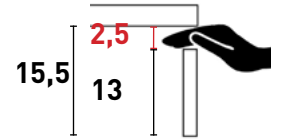

Disponibles cajones de 11, 16 y 25 cm de alto en costilla.



Ancho total de 40 a 60		Ancho total de 60,1 a 80		Ancho total de 80,1 a 100	
Altura Costilla	Altura Total	Altura Costilla	Altura Total	Altura Costilla	Altura Total
11	15,5	11	15,5	11	15,5
16	20,5	16	20,5	16	20,5
22	29,5	22	29,5	22	29,5

















Ref.	Puntos	Ref.	Puntos	Ref.	Puntos
CGN316	52	CGN318	60	CGN310	66
CGN366	56	CGN368	64	CGN360	70
CGN356	69	CGN358	77	CGN350	73

El precio de los lados de la cajonera va incluido en cada cajón.

Ancho total de 40 a 60	Ancho total de 60,1 a 80	Ancho total de 80,1 a 100
		
Tapa y base	Tapa y base	Tapa y base
Ref. CFN348	Ref. CFN368	Ref. CFN380
Puntos 55	Puntos 67	Puntos 78

Seleccionar altura y cantidad de cajones + una tapa (obligatoria), todos del mismo ancho. Con estas referencias ya podemos crear la cajonera de libre composición.

Ejemplo de cajonera de 40 a 60:

<table border="0"> <tr> <td>11</td> <td></td> <td>CGN316</td> <td>52</td> </tr> <tr> <td>16</td> <td></td> <td>CGN366</td> <td>56</td> </tr> <tr> <td>16</td> <td></td> <td>CGN366</td> <td>56</td> </tr> <tr> <td>22</td> <td></td> <td>CGN356</td> <td>69</td> </tr> </table>	11		CGN316	52	16		CGN366	56	16		CGN366	56	22		CGN356	69	<p>+</p>  <p>CFN348 55</p> <p>=</p>	<table border="0"> <tr> <td></td> <td> <p>CFN348</p> <p>CGN316</p> <p>CGN366</p> <p>CGN366</p> <p>CGN356</p> </td> </tr> <tr> <td></td> <td> <p>Altura frente + espacio entre cajones</p> <p>3 Altura Tapa</p> <p>15,5 Altura Costilla 11</p> <p>20,5 Altura Costilla 16</p> <p>20,5 Altura Costilla 16</p> <p>29,5 Altura Costilla 22</p> <p>3 Altura Tapa</p> </td> </tr> <tr> <td></td> <td> <p>Puntos Total</p> <p>(52 + 56 + 56 + 69) + 55</p> <p>288</p> </td> </tr> <tr> <td></td> <td> <p>Altura Total</p> <p>(3 + 15,5 + 20,5 + 20,5 + 29,5 + 3)</p> <p>92</p> </td> </tr> </table>		<p>CFN348</p> <p>CGN316</p> <p>CGN366</p> <p>CGN366</p> <p>CGN356</p>		<p>Altura frente + espacio entre cajones</p> <p>3 Altura Tapa</p> <p>15,5 Altura Costilla 11</p> <p>20,5 Altura Costilla 16</p> <p>20,5 Altura Costilla 16</p> <p>29,5 Altura Costilla 22</p> <p>3 Altura Tapa</p>		<p>Puntos Total</p> <p>(52 + 56 + 56 + 69) + 55</p> <p>288</p>		<p>Altura Total</p> <p>(3 + 15,5 + 20,5 + 20,5 + 29,5 + 3)</p> <p>92</p>
11		CGN316	52																							
16		CGN366	56																							
16		CGN366	56																							
22		CGN356	69																							
	<p>CFN348</p> <p>CGN316</p> <p>CGN366</p> <p>CGN366</p> <p>CGN356</p>																									
	<p>Altura frente + espacio entre cajones</p> <p>3 Altura Tapa</p> <p>15,5 Altura Costilla 11</p> <p>20,5 Altura Costilla 16</p> <p>20,5 Altura Costilla 16</p> <p>29,5 Altura Costilla 22</p> <p>3 Altura Tapa</p>																									
	<p>Puntos Total</p> <p>(52 + 56 + 56 + 69) + 55</p> <p>288</p>																									
	<p>Altura Total</p> <p>(3 + 15,5 + 20,5 + 20,5 + 29,5 + 3)</p> <p>92</p>																									

ESTRUCTURA

Cajón frente cristal

Costillas laterales acabado único ANTRACITA

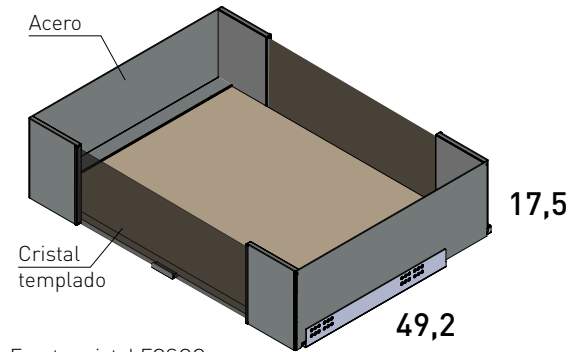

Frente cristal FOSCO

Acabados laminados base cajón

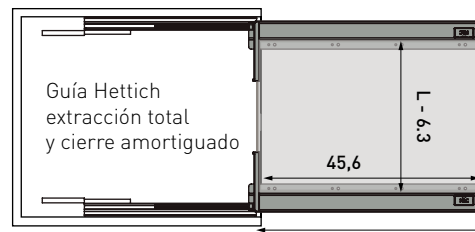
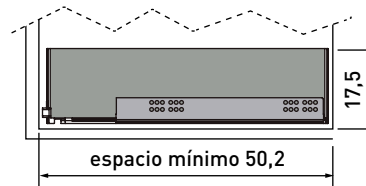

Fácil montaje
Espaciador para salvar bisagras incorporado

L hueco armario	Ref.	Puntos
40-50	CF140	171
50-60	CF150	177
60-70	CF160	180
70-80	CF170	191
80-90	CF180	198
90-100	CF190	204
100-110	CF100	211
110-116	CF110	218

Cajón frente cristal

Costillas laterales acabado único ANTRACITA

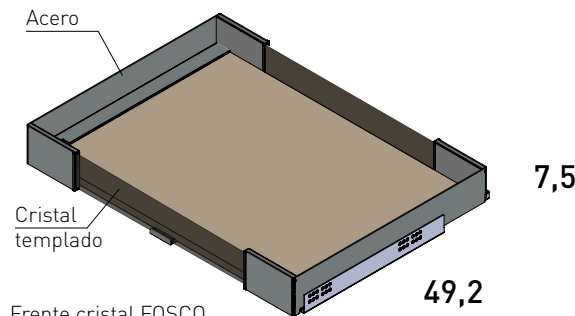

Frente cristal FOSCO

Acabados laminados base cajón

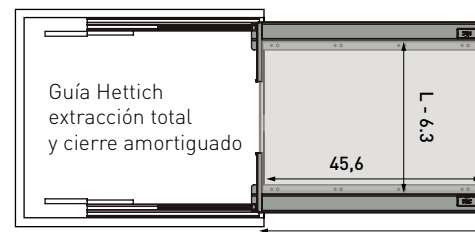
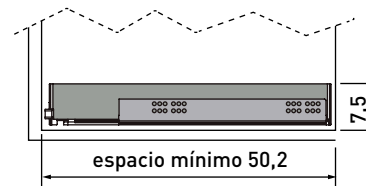

Fácil montaje
Espaciador para salvar bisagras incorporado

L hueco armario	Ref.	Puntos
40-50	CF740	158
50-60	CF750	162
60-70	CF760	166
70-80	CF770	173
80-90	CF780	179
90-100	CF790	186
100-110	CF700	193
110-116	CF711	201

COMPLEMENTOS

Joyero organizador

Acabado TITANIO

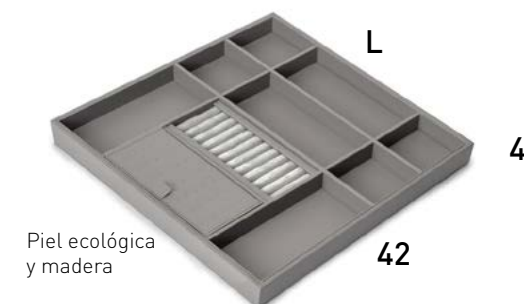

Piel ecológica y madera

L	Ref.	Puntos
44	JR4	88
54	JR5	100
64	JR6	112
74	JR7	124

Caja accesorios

Acabado único ANTRACITA
Acero

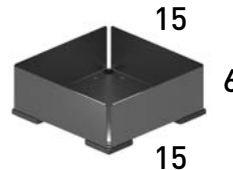

L	Ref.	Puntos
15	CAJ15	24

Bandeja accesorios

Acabado único ANTRACITA
Acero



L	Ref.	Puntos
28	BAN28	28
45	BAN45	30

ESTRUCTURA

Cajón zapatero frente cristal

Costillas laterales acabado único ANTRACITA

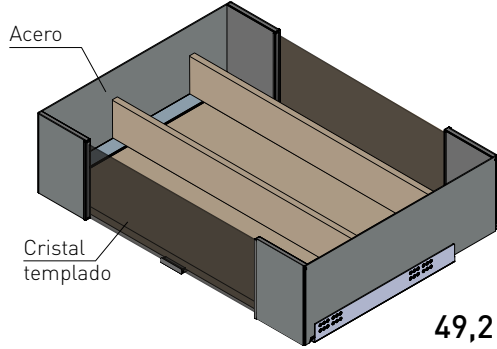

Frente cristal FOSCO

Acabados laminados base cajón

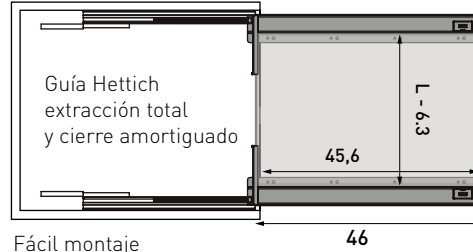
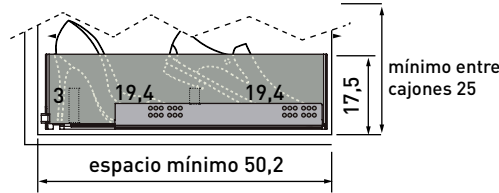

Fácil montaje
Espaciador para salvar bisagras incorporado

L hueco armario	Ref.	Puntos
40-50	CZ40	184
50-60	CZ50	191
60-70	CZ60	199
70-80	CZ70	210
80-90	CZ80	219
90-100	CZ90	226
100-110	CZ10	235
110-116	CZ11	242

COLGADORES

Perchero Abatible

Acabado único ANTRACITA
Acero

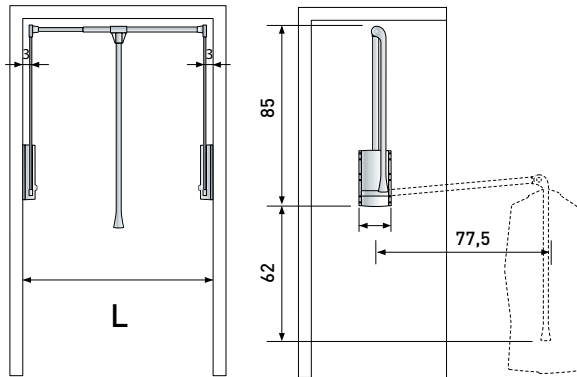
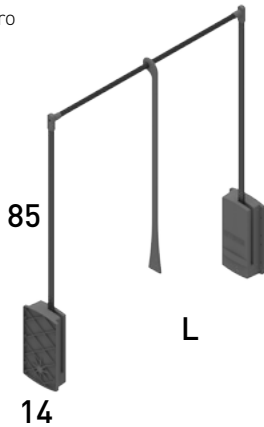

L hueco armario	Ref.	Puntos
44-60	PER4	114
60-90	PER6	130
90-116	PER7	134

Perchero extraíble SUPERIOR

Acabado único ANTRACITA
Acero

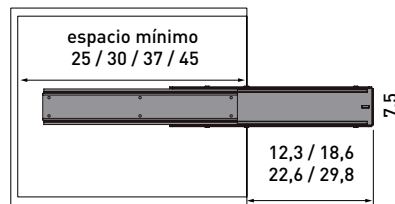
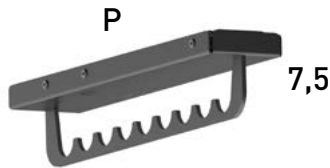

P	Ref.	Puntos
24	PEX24	44
29	PEX29	46
36	PEX36	48
44	PEX44	50

Barras colgar

Acabado ANTRACITA
Aluminio

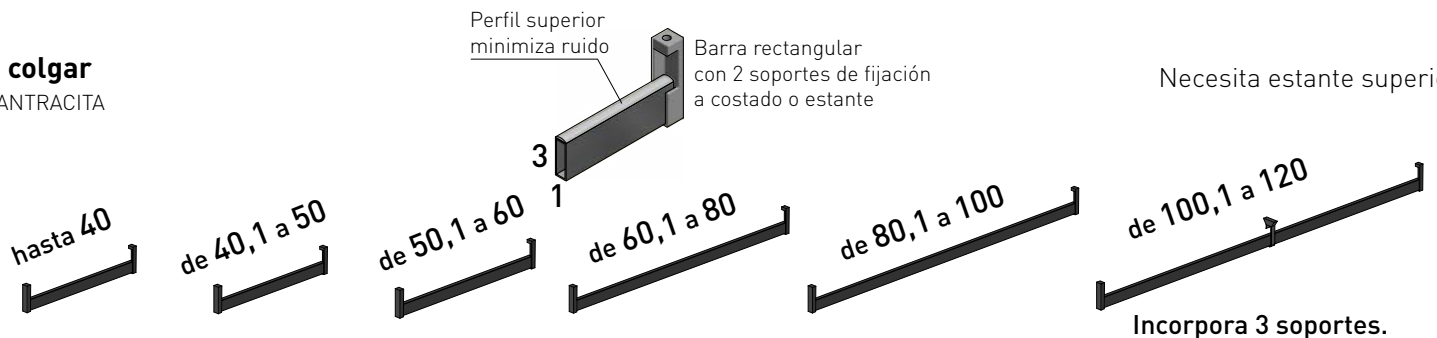

Ref.	BL40	BL50	BL60	BL80	BL10	BL12
Puntos	18	21	25	27	30	38

ACCESORIOS

Zapatero lateral extraíble

Acabado único ANTRACITA
Acero

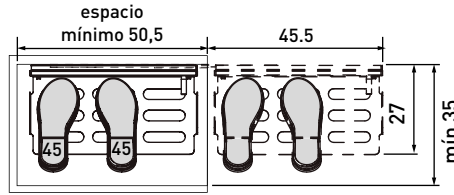
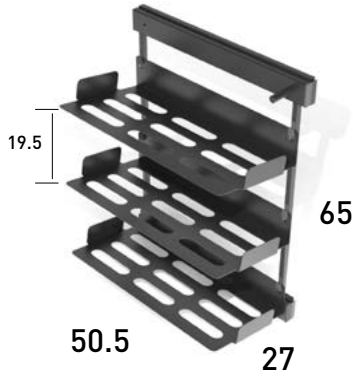

Espaciador para salvar bisagras incorporado

L	Ref.	Puntos
DR	Z65D	196
IZ	Z65Z	196

Cesta de tela

Estructura ANTRACITA
Acero / Tela gris

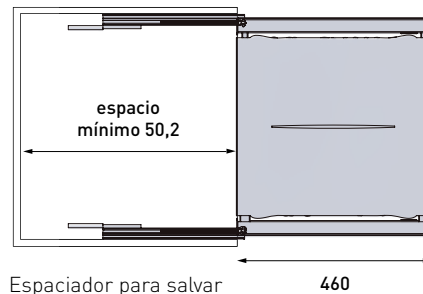

Espaciador para salvar bisagras incorporado

L	Ref.	Puntos
53,5-58,5	CET5	226
58,5-63,5	CET6	234

Corbatero lateral extraíble

Acabado único ANTRACITA
Acero

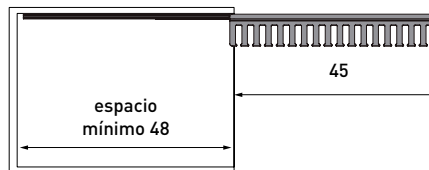
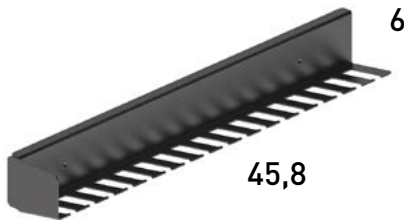

Espaciador para salvar bisagras incorporado

L	Ref.	Puntos
DR	CORD	65
IZ	CORZ	65

Espejo lateral extraíble

Acabado único GRAFITO

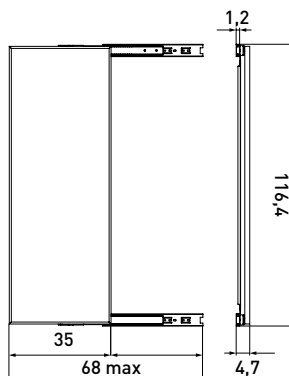
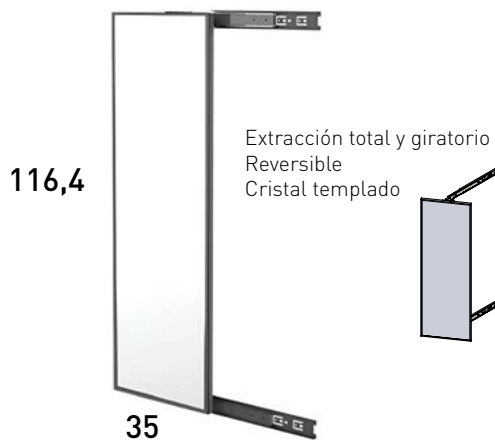

Espaciador para salvar bisagras incorporado

L	Ref.	Puntos
35	ESPEX	90

Guía Hettich extracción total y cierre amortiguado
Soportes con funda antideslizante

PANTALONEROS

Bandeja pantalonero

Acabado único ANTRACITA
Acero



Carga máxima 30kg

49



Fácil montaje
Espaciador para salvar bisagras incorporado

Soportes	L	Ref.	Puntos
7-9	50,5-60,5	PAX60	204
9-11	60,5-70,5	PAX70	209
11-13	70,5-80,5	PAX80	219
13-15	80,5-90,5	PAX90	227

Bandeja accesorios

Acabado único ANTRACITA



* Bandejas recomendadas según medida
de 50,5 a 65,5 cm 1 unidad
de 65,5 a 85,5 cm 2 unidades
de 85,5 a 90,5 cm 3 unidades

Ref.	Puntos
BDA24	14

Pantalonero extraíble LATERAL

Acabado único ANTRACITA
Acero

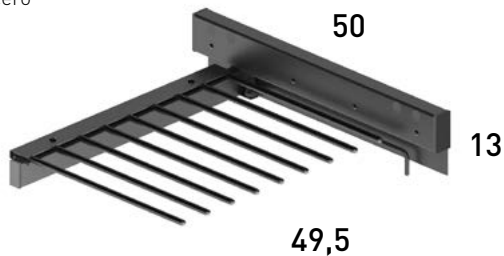

Reversible
Para 9 pantalones

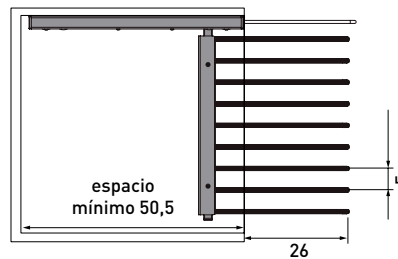

Espaciador para salvar bisagras incorporado

Ref.	Puntos
PAXL	133

Pantalonero extraíble SUPERIOR

Acabado único ANTRACITA
Acero

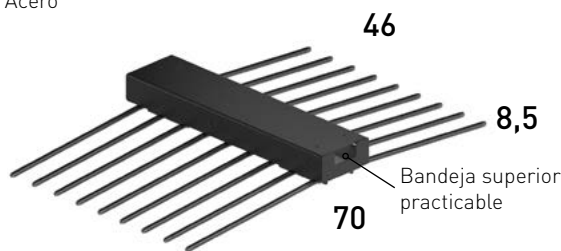

Para 18 pantalones.
Necesita estante superior

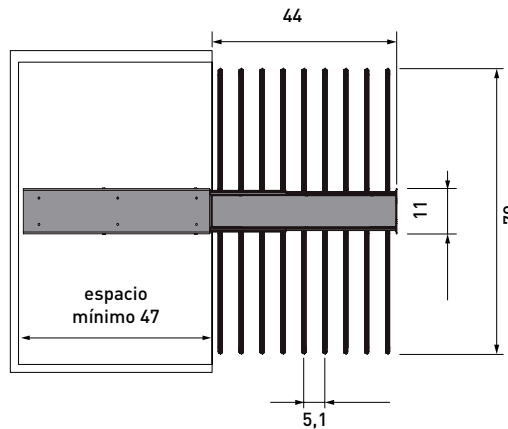

Ref.	Puntos
PAX18	148

Pantalonero extraíble SUPERIOR

Acabado único ANTRACITA
Acero

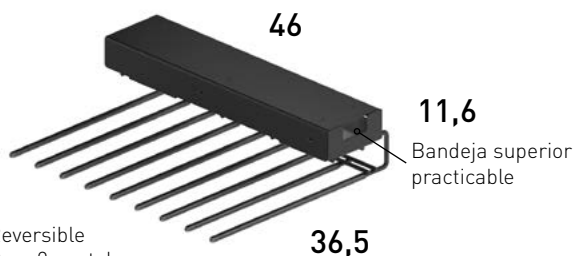

Reversible
Para 9 pantalones
Necesita estante superior

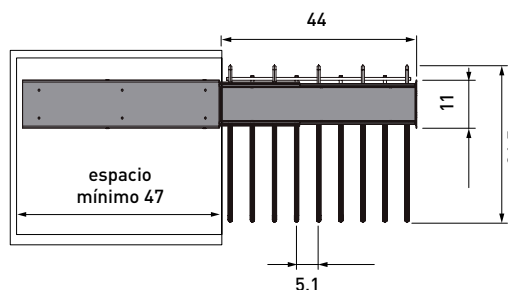

Ref.	Puntos
PAX9	112



Estructuras para interiores de armario
(Interiores no regulables en altura)



Columnas aluminio

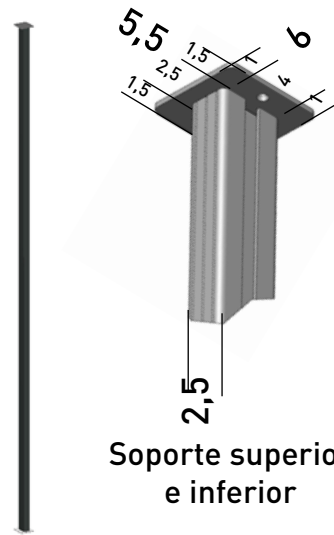

Altura	Ref.	Puntos
150 - 200	CAL1	86
201 - 274	CAL2	96

- Blanco
- Vulcano

Estos estantes no tienen mano.



ESTANTES FONDO 55

Grueso 3

hasta 40



1 soporte incluido + 2 soportes UX

de 40,1 a 50



1 soporte incluido + 2 soportes UX

de 50,1 a 60



1 soporte incluido + 2 soportes UX

Ref.	ET94	ET95	ET96
Puntos	37	40	44

Grueso 3

de 60,1 a 80



1 soporte incluido + 2 soportes UX

de 80,1 a 100

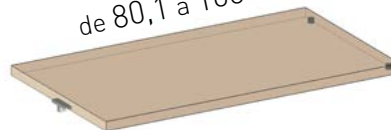

1 soporte incluido + 2 soportes UX

de 100,1 a 120

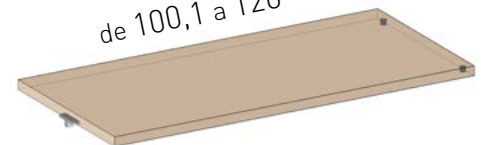

1 soporte incluido + 2 soportes UX

Ref.	ET98	ET90	ET92
Puntos	47	49	54



ESTANTES EXTRAIBLE FONDO 55

No tiene mano
Soportes incluidos

Grosor 3

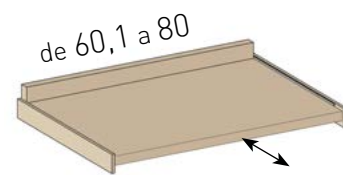
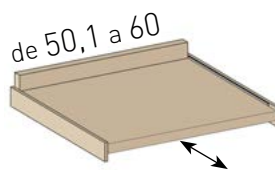
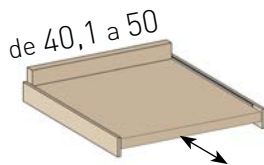

Ref.	ETX44	ETX54	ETX64	ETX84
Puntos	69	72	76	79

ESTANTES CRISTAL FONDO 55

No tiene mano
Soportes incluidos

Grosor 0.6

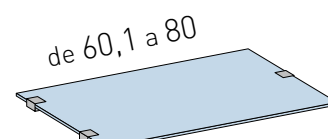
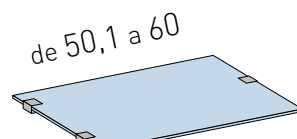
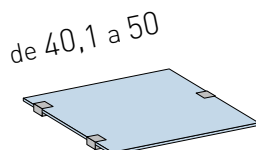
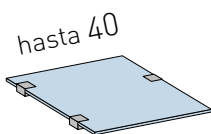

Ref.	EV44	EV54	EV64	EV84
Puntos	66	74	82	99

Grosor 0.6

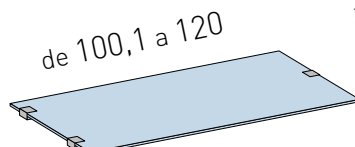
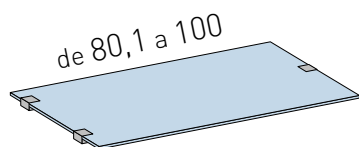

Acabados cristal
transparente y opaco

Acabados soporte
estante cristal



Ref.	EV104	EV124
Puntos	126	142

ZAPATERO FIJO FONDO 55

Soportes incluidos

Grosor 3

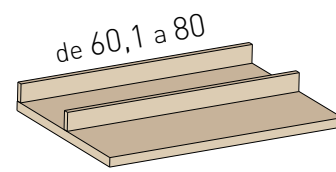
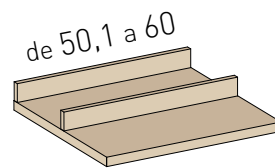
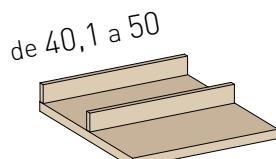
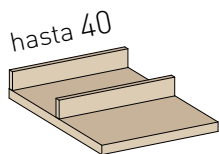

Ref.	EZ44Z	EZ44D	EZ54Z	EZ54D	EZ64Z	EZ64D	EZ84Z	EZ84D
Puntos	49	49	53	53	57	57	62	62

Grosor 3

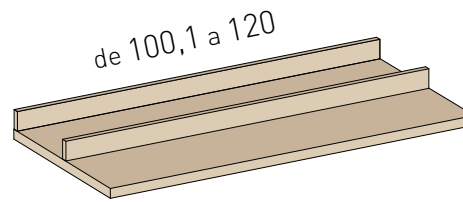
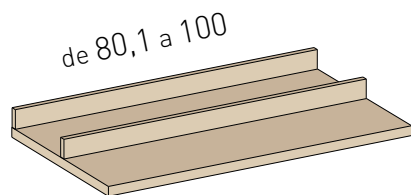

Ref.	EZ104Z	EZ104D	EZ124Z	EZ124D
Puntos	65	65	71	71



ZAPATERO EXTRAIBLE FONDO 55

No tiene mano
Soportes incluidos

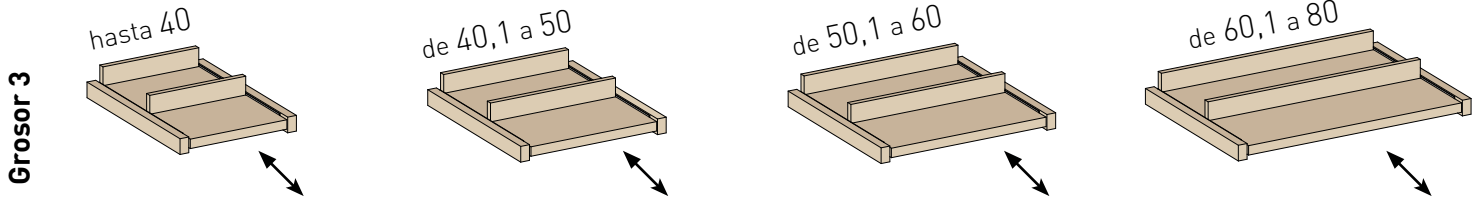

Ref.	EX44	EX54	EX64	EX84
Puntos	71	75	80	84

BARRAS

No tiene mano
Soportes incluidos

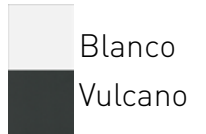

Cada barra incorpora un juego de dos soportes.

Ref.	BC45	BC56	BC68	BC100
Puntos	27	30	33	41

CAJONERAS FONDO 55

Para cajón separador pag 218

Costilla de 11

No tiene mano
Soportes incluidos

Altura 21,5



Ref.	CG163	CG183	CG103
Puntos	114	134	152

Altura 37



Ref.	CG263	CG283	CG203
Puntos	166	195	218

PANTALONEROS FONDO 55

No tiene mano
Soportes incluidos

Altura 18,5

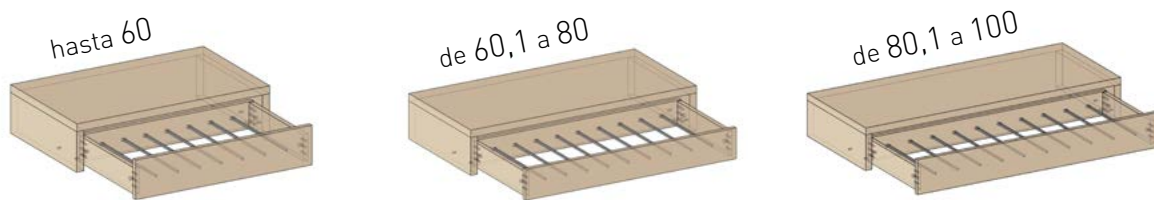

Ref.	PNT607	PNT687	PNT107
Puntos	162	182	198

OPCIONES RAIL SYSTEM

EJEMPLO ELECCIÓN DE INTERIORES

Añade una referencia de sistema de guías **por cada hueco** que desees equipar con **Rail System**

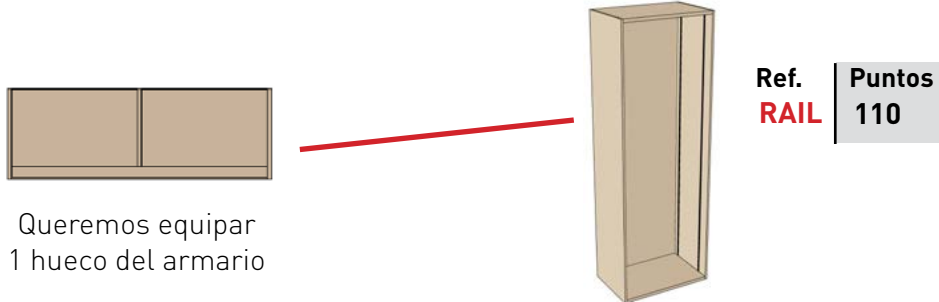

Queremos equipar 1 hueco del armario

Deseamos añadir 2 estantes, una barra de colgar y una cajonera al interior de un armario de 195 cm, de 239 cm de altura.

Buscar las opciones de interior deseadas para un hueco interior de 95,5

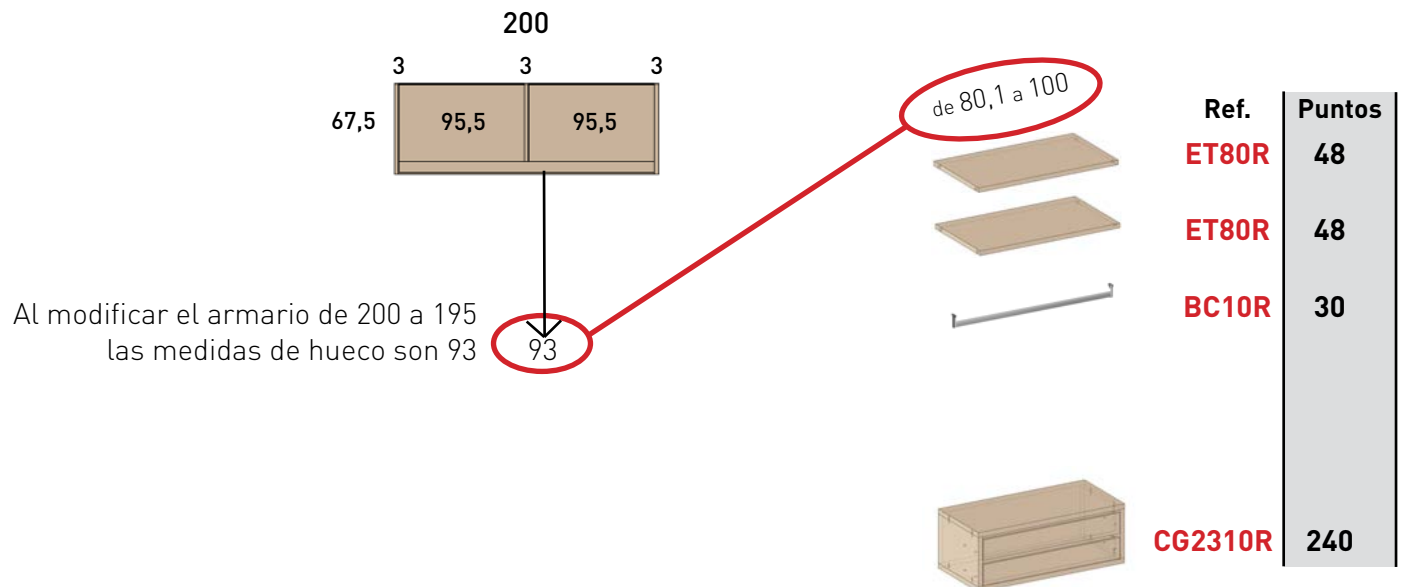

Al modificar el armario de 200 a 195 las medidas de hueco son 93

Las opciones de interior se adaptan a la medida exacta del hueco interior.

No hay incremento en los puntos por recortar las opciones, son 110 puntos por Rail System 1 hueco +366 puntos por interiores un total de **476 puntos**

OPCIONES PARA CORREDERAS INTERIORES CON RAIL SYSTEM

RAIL SYSTEM

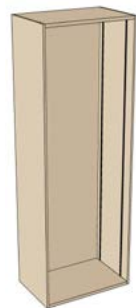

* Incluir una referencia por cuerpo

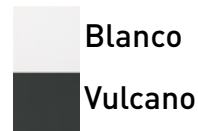

Ref.	RAIL
Puntos	110

ESTANTES FONDO 55

Grosor 3

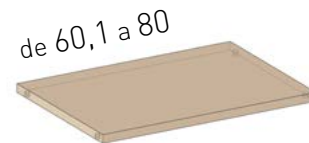
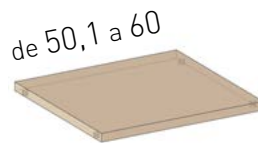
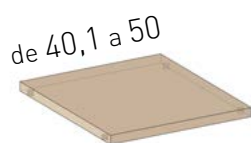
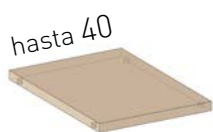

Ref.	ET84R	ET85R	ET86R	ET88R
Puntos	36	39	43	46

Grosor 3

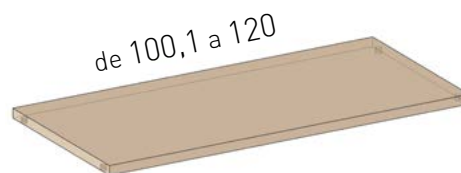
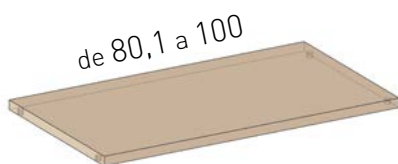

* Incluye 4 soportes

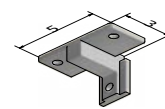
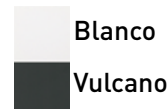

Ref.	ET80R	ET82R
Puntos	48	53

ESTANTES EXTRAIBLES FONDO 55

Grosor 3

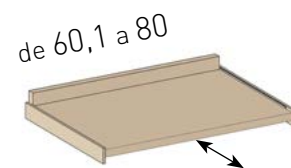
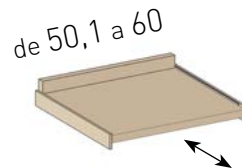
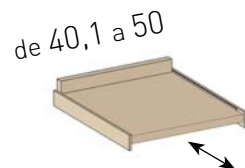
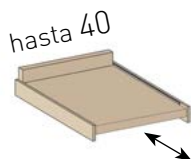

Ref.	ETT84R	ETT85R	ETT86R	ETT88R
Puntos	68	71	75	79

Grosor 3

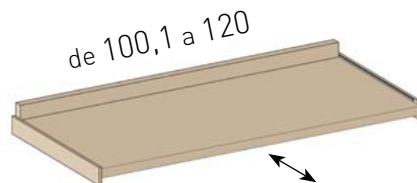
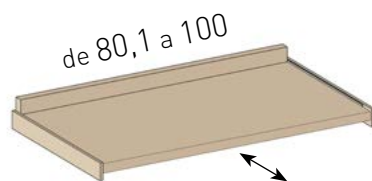

* Incluye 4 soportes

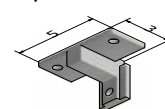
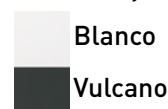

Ref.	ETT80R	ETT82R
Puntos	80	85

BARRAS

Blanco * Obligatorio un estante superior
 Vulcano

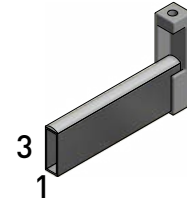

Barra rectangular con 2 soportes de fijación a estante. Perfil superior minimiza ruido.

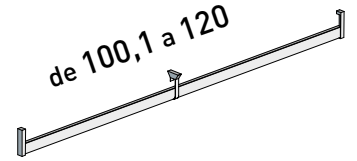
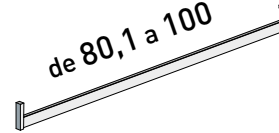
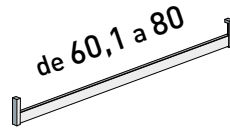
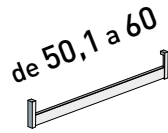
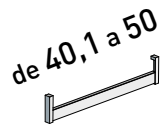
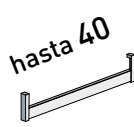

Incorpora 3 soportes.

Ref.	BC4R	BC5R	BC6R	BC8R	BC10R	BC12R
Puntos	18	21	24	27	30	37

ESTANTES CRISTAL FONDO 55

Grosor 0,6

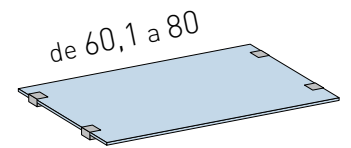
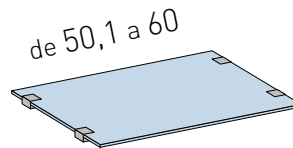
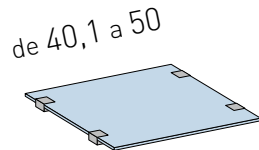
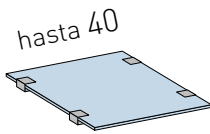

Ref.	EV43R	EV53R	EV63R	EV83R
Puntos	76	84	92	108

Grosor 0,6

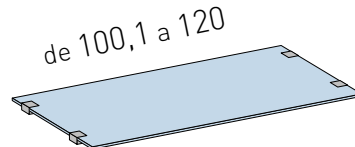
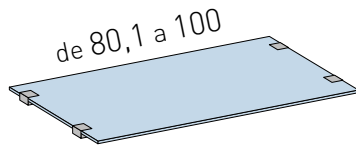

Acabados cristal transparente y opaco



Acabados soporte estante cristal



Ref.	EV103R	EV123R
Puntos	126	152

ZAPATERO FIJO FONDO 55

Grosor 3

hasta 40

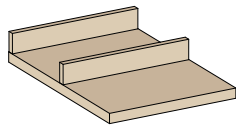

de 40,1 a 50

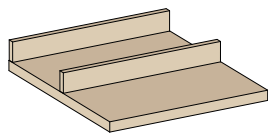

de 50,1 a 60

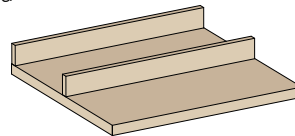

de 60,1 a 80

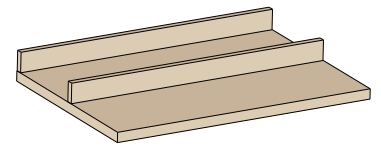

Ref.	EZ43R	EZ53R	EZ63R	EZ83R
Puntos	48	52	57	61

Grosor 3

de 80,1 a 100

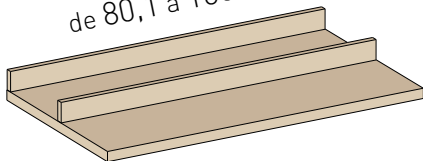

de 100,1 a 120

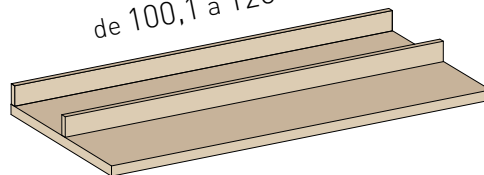

* Incluye 4 soportes

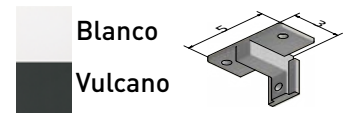

Ref.	EZ103R	EZ123R
Puntos	64	70

ZAPATERO EXTRAÍBLE FONDO 55

Grosor 3

hasta 40

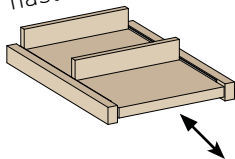

de 40,1 a 50

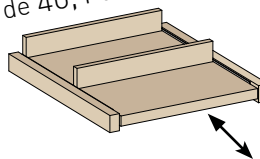

de 50,1 a 60

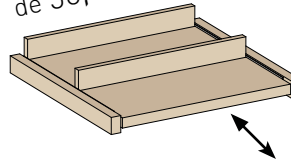

de 60,1 a 80

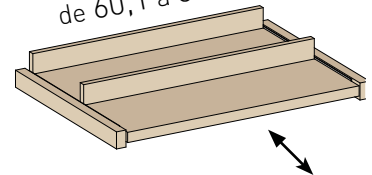

Ref.	EX43R	EX53R	EX63R	EX83R
Puntos	73	77	82	86

Grosor 3

de 80,1 a 100

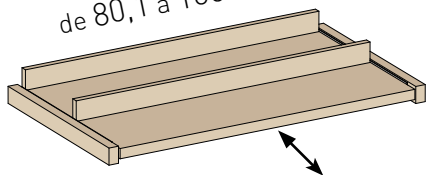

de 100,1 a 120

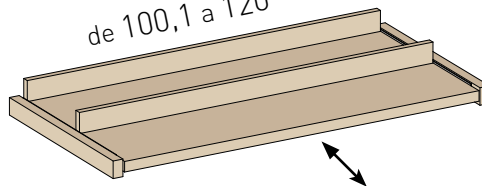

* Incluye 4 soportes

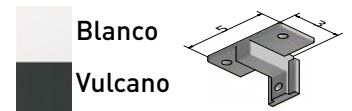

Ref.	EX103R	EX123R
Puntos	89	95

OPCIONES PARA CORREDERAS INTERIORES CON RAIL SYSTEM

PARTIDORES FONDO 55

Grosor 3

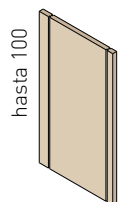

hasta 100

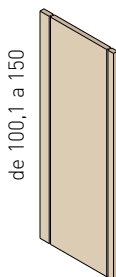

de 100,1 a 150



de 150,1 a 200



desde 200,1

* Por defecto incluye Rail System por ambos lados

Ref.	DNT103R	DNT153R	DNT203R	DNT303R
Puntos	94	124	163	174

PARTIDORES ALUMINIO

Blanco
Vulcano

* Compatible solo con cajoneras colgadas

Grosor 3



hasta 100

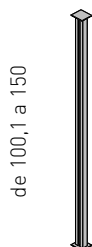

de 100,1 a 150



de 150,1 a 200



desde 200,1

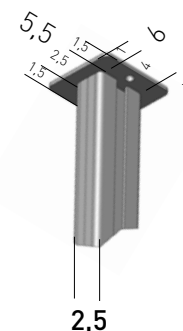

Soporte superior e inferior

Ref.	CAL10	CAL15	CAL20	CAL30
Puntos	46	52	86	96

OPCIONES

Zapatero extensible y extraíble

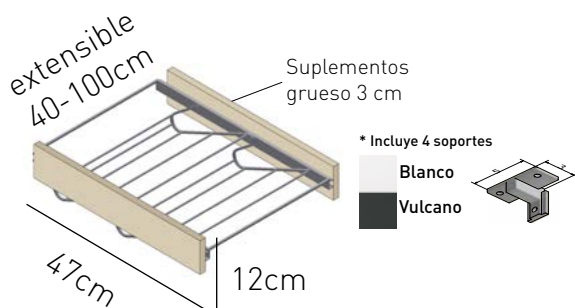

Barra abatible y extensible

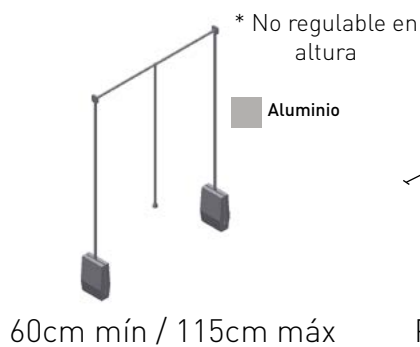

Mesa planchar plegable

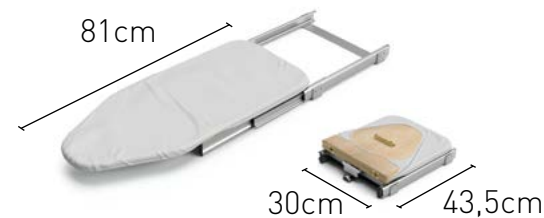

Precisa de un estante de soporte.

Ref.	ZPR3	BRT	TPL
Puntos	105	110	168

LEDS

1 tira de led



*Sensor movimiento incorporado

2 tiras de leds



Ref.	LED10	LED20
Puntos	168	288

COSTILLA 11

* Incluye 4 soportes



Altura 21,5

hasta 40



de 40,1 a 60



de 60,1 a 80



de 80,1 a 100



de 100,1 a 120



Ref.	CG1314R	CG1316R	CG1318R	CG1310R	CG1312R
Puntos	115	131	151	168	228

Altura 37

hasta 40



de 40,1 a 60



de 60,1 a 80



de 80,1 a 100



de 100,1 a 120



Ref.	CG2314R	CG2316R	CG2318R	CG2310R	CG2312R
Puntos	165	183	211	234	332

Altura 52,5

hasta 40



de 40,1 a 60



de 60,1 a 80



de 80,1 a 100



Ref.	CG3314R	CG3316R	CG3318R	CG3310R
Puntos	215	235	271	300

Altura 68

hasta 40



de 40,1 a 60



de 60,1 a 80



de 80,1 a 100



Ref.	CG4314R	CG4316R	CG4318R	CG4310R
Puntos	265	287	331	366

* Incluye 4 soportes



Altura 18,5

hasta 60

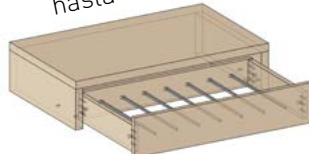

de 60,1 a 80

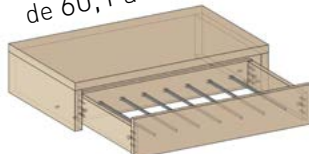

de 80,1 a 100

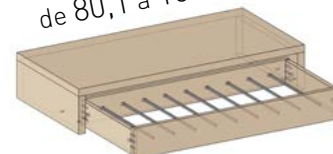

Ref.	PNT606R	PNT686R	PNT106R
Puntos	174	188	204

CAJONERAS FONDO 55

COSTILLA 16

* Incluye 4 soportes

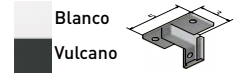

Altura 26,5

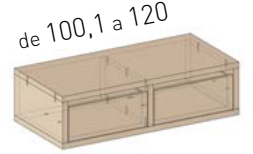

Ref.	CG1364R	CG1366R	CG1368R	CG1360R	CG1362R
Puntos	120	135	155	172	236

Altura 47

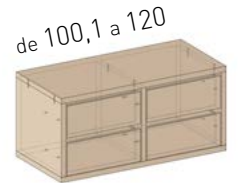

Ref.	CG2364R	CG2366R	CG2368R	CG2360R	CG2362R
Puntos	170	191	219	242	348

Altura 67,5



Ref.	CG3364R	CG3366R	CG3368R	CG3360R
Puntos	225	247	283	312

SEPARADORES CAJONES

Incremento por separadores (Cajón no incluido)

Altura 18,5

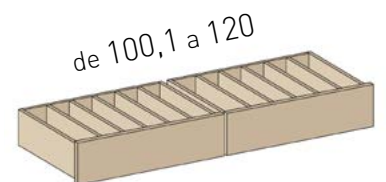
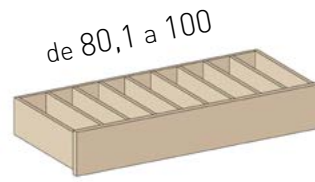
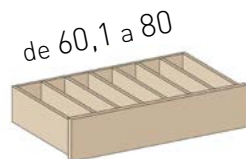

Ref.	CRB603	CRB683	CRB103	CRB123
Puntos	24	30	34	42

CASILLERO FONDO 55

* Incluye 4 soportes



Altura 36

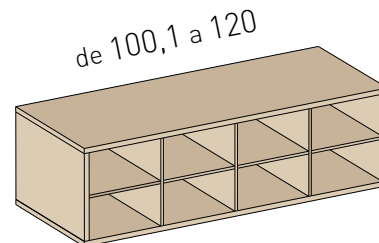
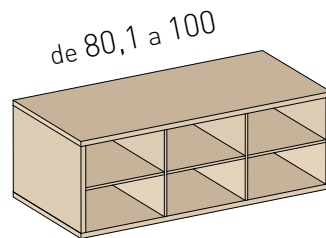
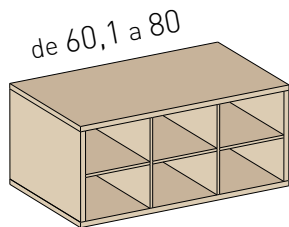

Ref.	CS82R	CS102R	CS122R
Puntos	120	144	176

Disponibles cajones de 11 y 16 cm de alto en costilla.

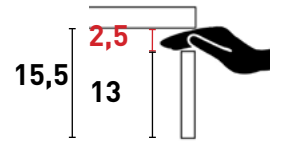

Ancho total de 40 a 60	Ancho total de 60,1 a 80	Ancho total de 80,1 a 100																																				
<table border="1"> <tr> <th>Altura Costilla</th> <th>Altura Total</th> <th>Ref.</th> <th>Puntos</th> </tr> <tr> <td>11</td> <td>15,5</td> <td>CGN316R</td> <td>52</td> </tr> <tr> <td>16</td> <td>20,5</td> <td>CGN366R</td> <td>56</td> </tr> </table>	Altura Costilla	Altura Total	Ref.	Puntos	11	15,5	CGN316R	52	16	20,5	CGN366R	56	<table border="1"> <tr> <th>Altura Costilla</th> <th>Altura Total</th> <th>Ref.</th> <th>Puntos</th> </tr> <tr> <td>11</td> <td>15,5</td> <td>CGN318R</td> <td>60</td> </tr> <tr> <td>16</td> <td>20,5</td> <td>CGN368R</td> <td>64</td> </tr> </table>	Altura Costilla	Altura Total	Ref.	Puntos	11	15,5	CGN318R	60	16	20,5	CGN368R	64	<table border="1"> <tr> <th>Altura Costilla</th> <th>Altura Total</th> <th>Ref.</th> <th>Puntos</th> </tr> <tr> <td>11</td> <td>15,5</td> <td>CGN310R</td> <td>66</td> </tr> <tr> <td>16</td> <td>20,5</td> <td>CGN360R</td> <td>70</td> </tr> </table>	Altura Costilla	Altura Total	Ref.	Puntos	11	15,5	CGN310R	66	16	20,5	CGN360R	70
Altura Costilla	Altura Total	Ref.	Puntos																																			
11	15,5	CGN316R	52																																			
16	20,5	CGN366R	56																																			
Altura Costilla	Altura Total	Ref.	Puntos																																			
11	15,5	CGN318R	60																																			
16	20,5	CGN368R	64																																			
Altura Costilla	Altura Total	Ref.	Puntos																																			
11	15,5	CGN310R	66																																			
16	20,5	CGN360R	70																																			

El precio de los lados de la cajonera va incluido en cada cajón.

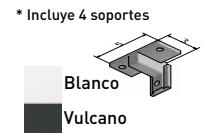

Ancho total de 40 a 60	Ancho total de 60,1 a 80	Ancho total de 80,1 a 100												
<table border="1"> <tr> <th>Ref.</th> <th>Puntos</th> </tr> <tr> <td>CFN346R</td> <td>79</td> </tr> </table> <p>Tapa y base</p>	Ref.	Puntos	CFN346R	79	<table border="1"> <tr> <th>Ref.</th> <th>Puntos</th> </tr> <tr> <td>CFN368R</td> <td>92</td> </tr> </table> <p>Tapa y base</p>	Ref.	Puntos	CFN368R	92	<table border="1"> <tr> <th>Ref.</th> <th>Puntos</th> </tr> <tr> <td>CFN380R</td> <td>102</td> </tr> </table> <p>Tapa y base</p>	Ref.	Puntos	CFN380R	102
Ref.	Puntos													
CFN346R	79													
Ref.	Puntos													
CFN368R	92													
Ref.	Puntos													
CFN380R	102													

Seleccionar altura y cantidad de cajones + una tapa (obligatoria), todos del mismo ancho. Con estas referencias ya podemos crear la cajonera de libre composición.

Ejemplo de cajonera de 40 a 60:

<table border="1"> <tr> <td>11</td> <td>CGN316R</td> <td>52</td> </tr> <tr> <td>16</td> <td>CGN366R</td> <td>56</td> </tr> <tr> <td>16</td> <td>CGN366R</td> <td>56</td> </tr> </table>	11	CGN316R	52	16	CGN366R	56	16	CGN366R	56	+	<table border="1"> <tr> <td>CFN346R</td> <td>79</td> </tr> </table>	CFN346R	79	=	<table border="1"> <tr> <td>CFN346R</td> <td>3</td> <td>Altura frente + espacio entre cajones</td> </tr> <tr> <td>CGN316R</td> <td>15,5</td> <td>Altura Tapa</td> </tr> <tr> <td>CGN366R</td> <td>20,5</td> <td>Altura Costilla 11</td> </tr> <tr> <td>CGN366R</td> <td>20,5</td> <td>Altura Costilla 16</td> </tr> <tr> <td>CGN366R</td> <td>20,5</td> <td>Altura Costilla 16</td> </tr> <tr> <td></td> <td>3</td> <td>Altura Tapa</td> </tr> </table>	CFN346R	3	Altura frente + espacio entre cajones	CGN316R	15,5	Altura Tapa	CGN366R	20,5	Altura Costilla 11	CGN366R	20,5	Altura Costilla 16	CGN366R	20,5	Altura Costilla 16		3	Altura Tapa
11	CGN316R	52																															
16	CGN366R	56																															
16	CGN366R	56																															
CFN346R	79																																
CFN346R	3	Altura frente + espacio entre cajones																															
CGN316R	15,5	Altura Tapa																															
CGN366R	20,5	Altura Costilla 11																															
CGN366R	20,5	Altura Costilla 16																															
CGN366R	20,5	Altura Costilla 16																															
	3	Altura Tapa																															
<p>Puntos Total (52 + 56 + 56) + 79 243</p>		<p>Altura Total (3 + 15,5 + 20,5 + 20,5 + 3) 62,5</p>																															

INCREMENTO POR COLOR MUESTRA

Por cada color cliente que se aplique hay un mínimo 176 puntos.
En el caso de no llegar al mínimo en el conjunto de piezas del mismo color, se aplicará esta cantidad.



Puertas



Forros



Perfilería



Frente cajón

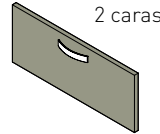

Tirador



Tapeta

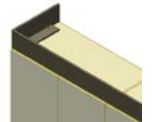

Precio metro lineal.

Ref.	altura	LAC1	altura	LAC2	altura	LAC3	LAC4	LAC5	LAC7
Puntos	120	64	120	42	120	32	15	10	12
	280	88	280	60	280	50	puntos/ud	puntos/ud	puntos/ml

Precio metro lineal

TAPETAS

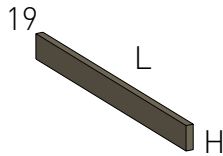

	Acabado BASE		Acabado STONE	
	Ref.	Pts ML	Ref.	Pts ML
sin chapar	8TA	8	8TS	10
1 canto chapado	8TA1	11	8TS1	13
2 cantos chapados	8TA2	14	8TS2	16
3 cantos chapados	8TA3	17	8TS3	19
4 cantos chapados	8TA4	20	8TS4	23

Especificar los cantos a chapar.
Largos o cortos.

Precio mínimo 1 metro lineal.

Ejemplo: Armario de 350 x 239 para hueco de 370 x 250

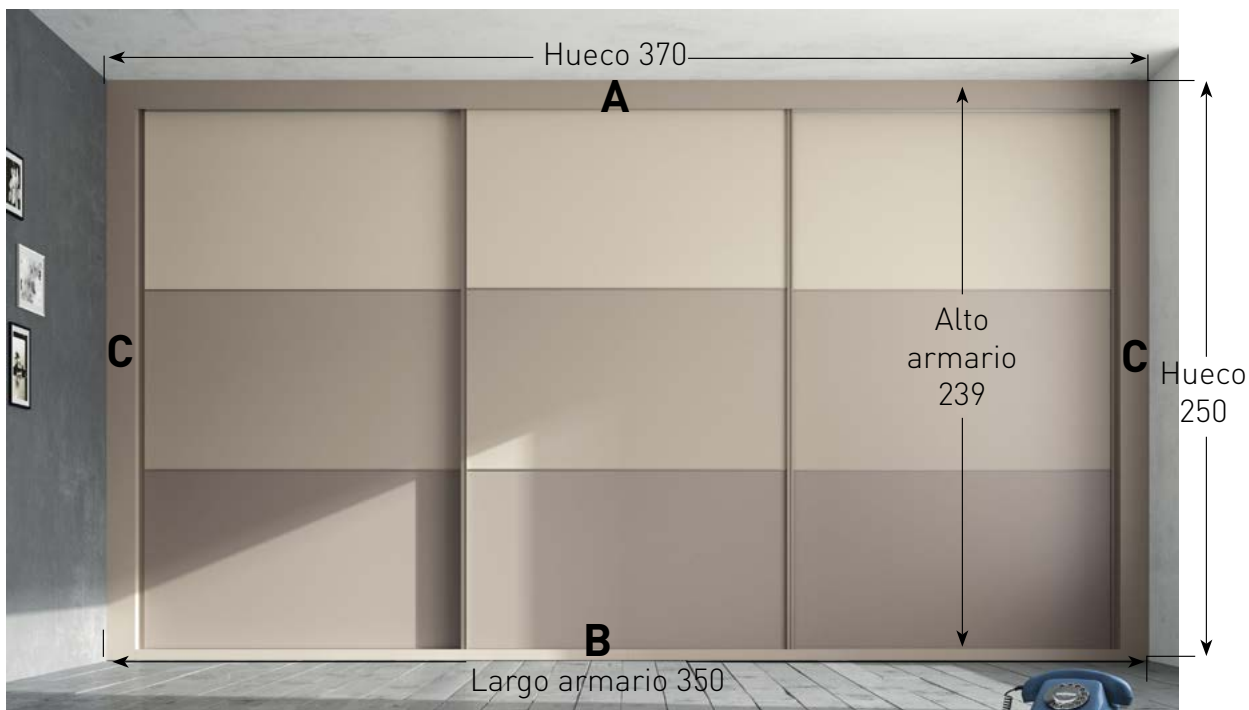

A **Largo** = Largo armario - Grueso costados
 $= 350 - 3 - 3 = \mathbf{344 \text{ cm}}$

Como es mas grande de 280 tiene
 que servirse en dos tapetas (172 x 18) x 2

Ancho = Alto hueco - Alto armario + Medida fija tapeta
 $= (250 - 239) + 7 = \mathbf{18 \text{ cm}}$

B **Largo** = Largo armario - Grueso costados
 $= 350 - 3 - 3 = \mathbf{344 \text{ cm}}$

Como es mas grande de 280 tiene
 que servirse en dos tapetas (172 x 4) x 2

Ancho = Grueso tapeta inferior (medida fija)
 $= \mathbf{4 \text{ cm}}$

C **Largo** = Alto hueco
 $= \mathbf{250 \text{ cm}}$

x 2 tapetas

Ancho = (Largo hueco - Largo armario) / 2 + Grueso costado
 $= (370 - 350) / 2 + 3 = \mathbf{13 \text{ cm}}$

ARMARIO POR DEFECTO

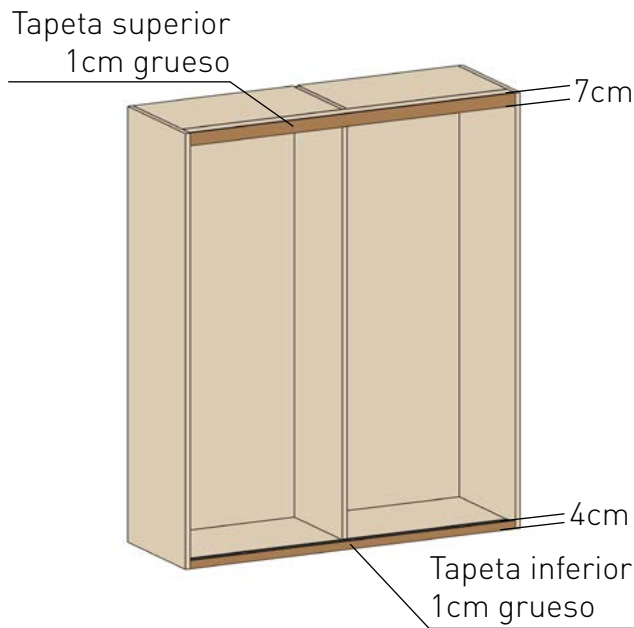

Estas tapetas que vienen por defecto con la caja estándar son para tapar las guías.

PARA PONER TAPETAS EN ESTE ARMARIO

1.- Sustituir la tapeta superior(A) e inferior(B) (por defecto de 1cm de grueso) por tapetas de 1,9cm de grueso.

2.- Elegir las tapetas laterales(C) de 1cm de grueso.

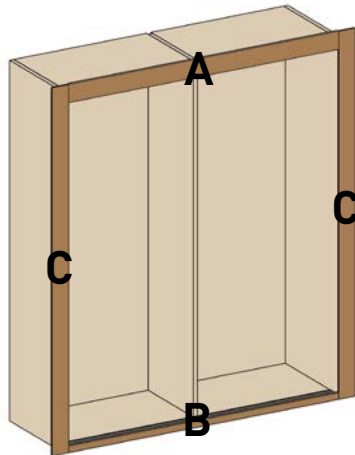

Las tapetas A, B y C son de diferente grosor para que queden totalmente enrasadas frontalmente.

En el caso de la tapeta inferior B, la medida de ancho es siempre fija de 4cm.

Máxima longitud tapeta: 280cm

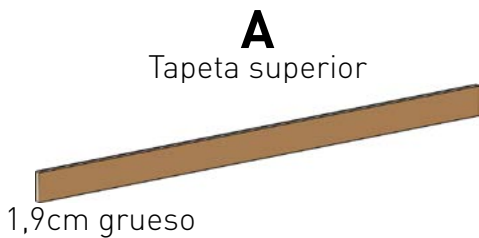

A
Tapeta superior

1,9cm grueso

Incremento por sustituir tapeta de 1cm por 1,9cm

Acabado BASE	TLA	Acabado STONE	TSA
	20		23

precio metro lineal

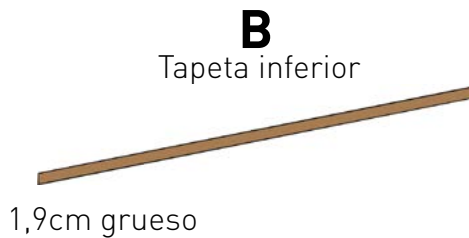

B
Tapeta inferior

1,9cm grueso

Incremento por sustituir tapeta de 1cm por 1,9cm

Acabado BASE	TLB	Acabado STONE	TSB
	10		11

precio metro lineal

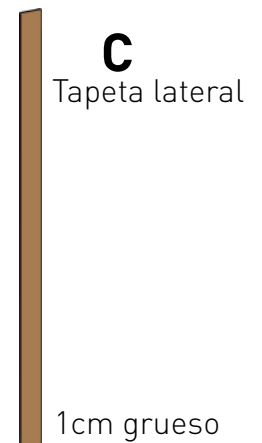

C
Tapeta lateral

1cm grueso

Acabado BASE	TLC	Acabado STONE	TSC
	16		18

precio metro lineal



COLUMNAS FONDO 56

Lado izquierdo

Altura	Ref.	Puntos
239	CLZ24	83
260	CLZ26	91
280	CLZ28	95

Mecanizado lado derecho

Parte central

Altura	Ref.	Puntos
239	CLC24	87
260	CLC26	96
280	CLC28	100

Mecanizado dos lados

Lado derecho

Altura	Ref.	Puntos
239	CLD24	83
260	CLD26	91
280	CLD28	95

Mecanizado lado izquierdo

BUCS FONDO 56

Grueso 3

Buc superior e inferior

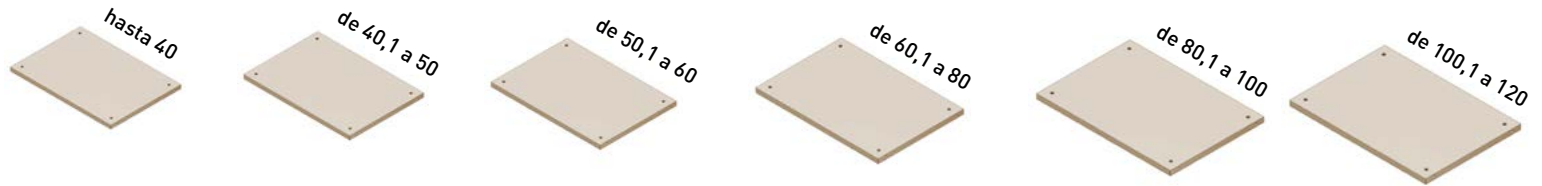

Ref.	BU24	BU25	BU26	BU28	BU210	BU212
Puntos	22	25	29	32	34	39

BUC / ESTANTE RINCÓN

Grueso 3

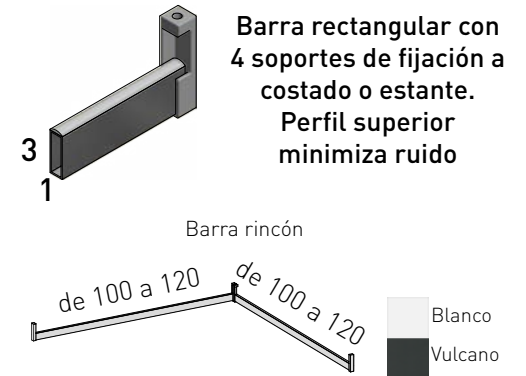
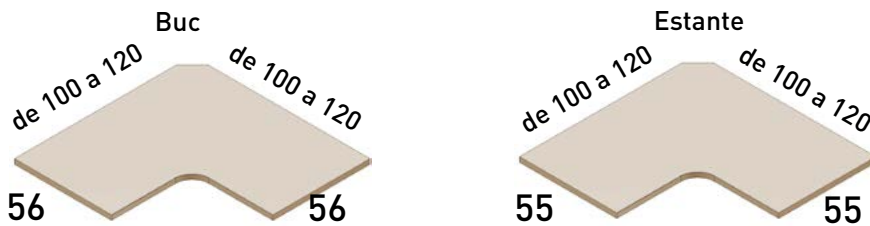

Ref.	BUR7	ER55	BN
Puntos	96	96	50

TAPETA RINCÓN



Altura	Ref.	Puntos
239	TR240	38
260	TR260	42
280	TR280	46

ESTANTES FONDO 55

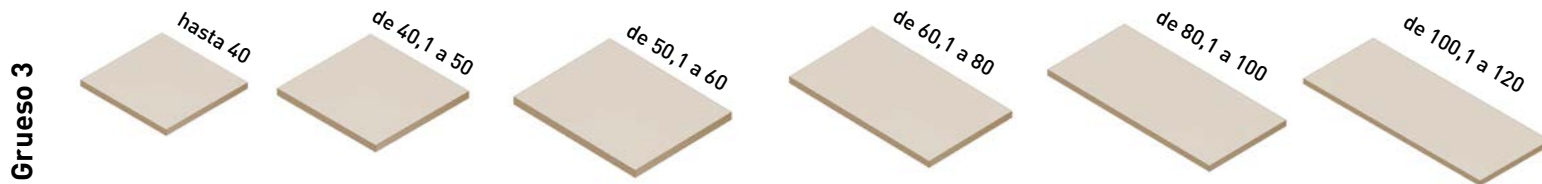

Ref.	ET84	ET85	ET86	ET88	ET80	ET82
Puntos	22	25	29	32	34	39

ESTANTES EXTRAIBLES FONDO 55



Ref.	ETT84	ETT85	ETT86	ETT88
Puntos	54	57	61	64

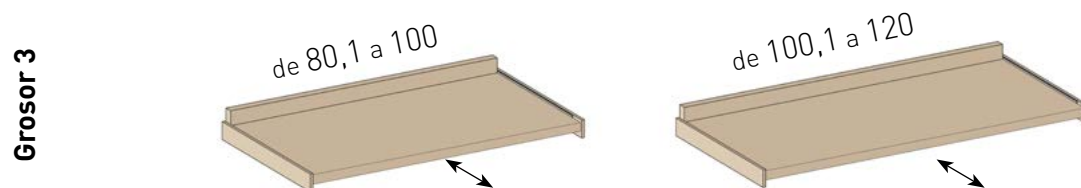

Ref.	ETT80	ETT82
Puntos	66	71

BARRAS

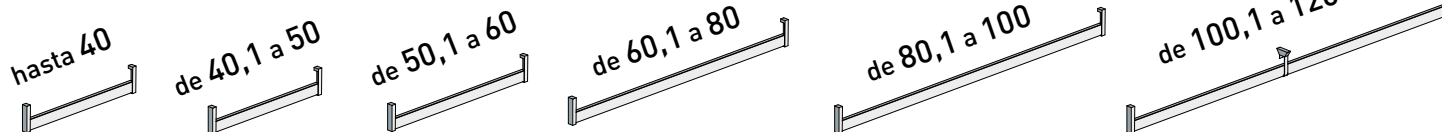
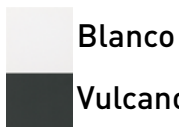

Barra rectangular con 2 soportes de fijación a costado o estante. Perfil superior minimiza ruido

Incorpora 3 soportes.

Ref.	BC4	BC5	BC6	BC8	BC10	BC12
Puntos	16	19	22	25	28	35

ESTANTES CRISTAL FONDO 55

Grosor 0.6

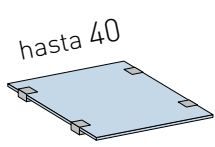

hasta 40

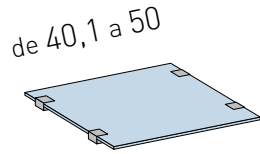

de 40,1 a 50

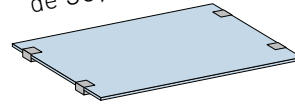

de 50,1 a 60

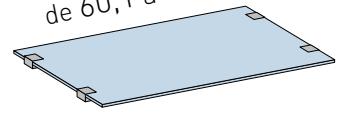

de 60,1 a 80

Ref.	EV43	EV53	EV63	EV83
Puntos	54	62	70	87

Grosor 0.6

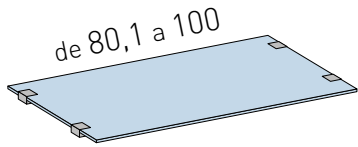

de 80,1 a 100

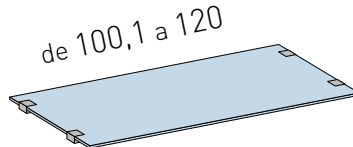

de 100,1 a 120

Acabados cristal transparente y opaco



Acabados soporte estante cristal



Ref.	EV103	EV123
Puntos	114	130

PARTIDORES FONDO 55

Grosor 3



hasta 100



de 100,1 a 150



de 150,1 a 200

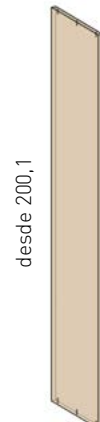

desde 200,1

Ref.	DNT103	DNT153	DNT203	DNT303
Puntos	49	54	58	64

ZAPATERO FIJO FONDO 55

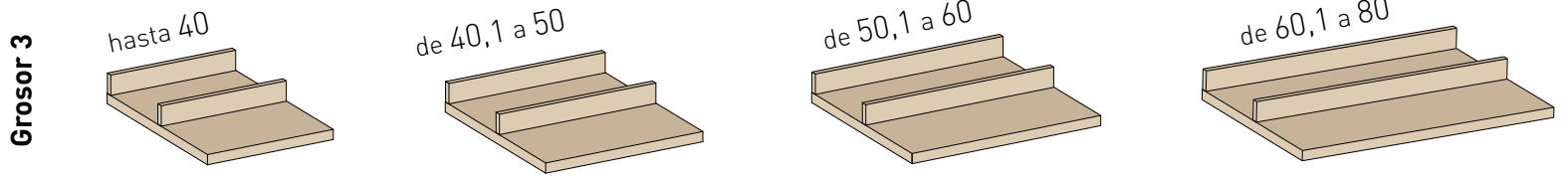

Ref.	EZ43	EZ53	EZ63	EZ83
Puntos	34	38	43	47

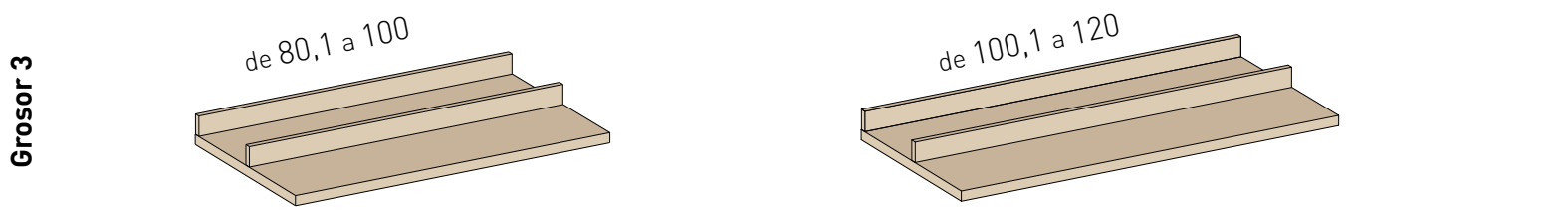

Ref.	EZ103	EZ123
Puntos	50	56

ZAPATERO EXTRAÍBLE FONDO 55

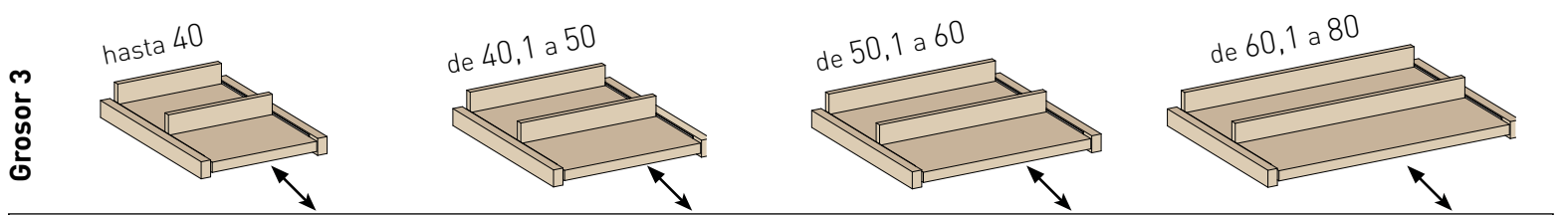

Ref.	EX43	EX53	EX63	EX83
Puntos	59	63	68	72

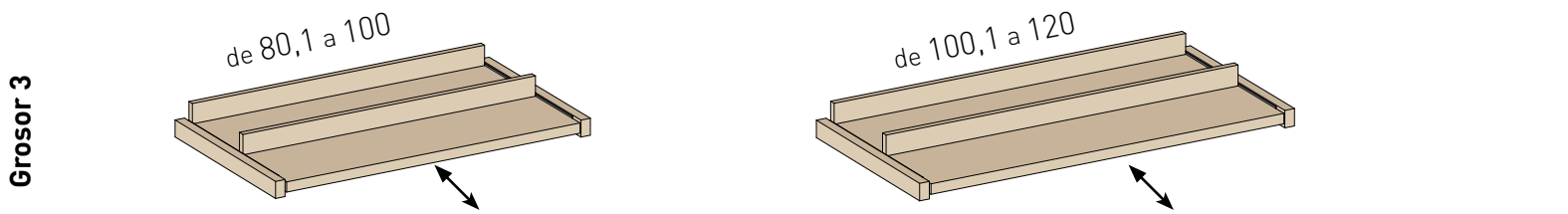

Ref.	EX103	EX123
Puntos	75	81

ZAPATERO INCLINADO FONDO 55

* Medidas especiales de fondo consultar con fábrica

Grosor 3

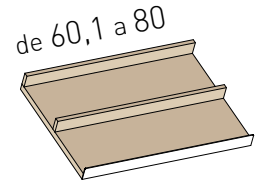
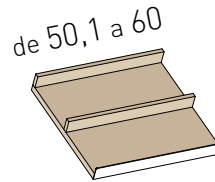
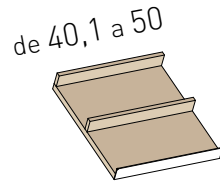

Ref.	EN43	EN53	EN63	EN83
Puntos	40	44	49	53

Grosor 3

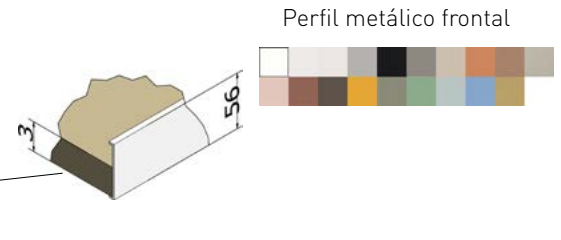
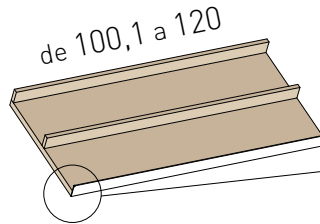
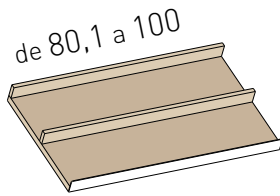

Ref.	EN103	EN123
Puntos	56	62

OPCIONES

Zapatero extensible y extraíble

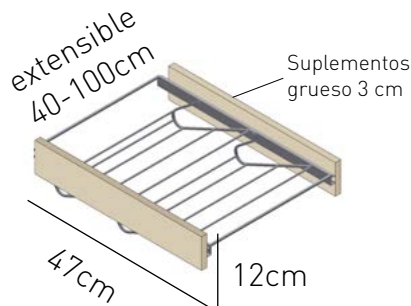

Barra abatible y extensible

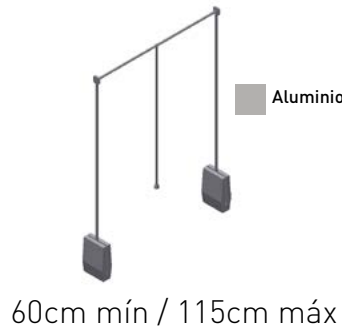

Mesa planchar plegable

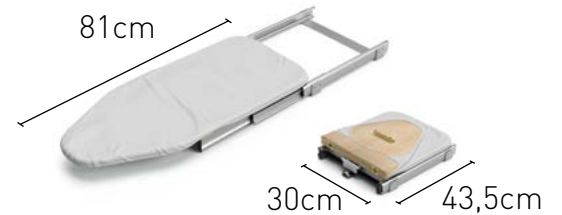

Precisa de un estante de soporte.

Ref.	ZPR	BRT	TPL
Puntos	100	110	168

LEDS

*Sensor movimiento incorporado

1 tira de led



2 tiras de leds



Ref.	LED10	LED20
Puntos	168	288

COSTILLA 11

Altura 21,5

hasta 60



de 60,1 a 80



de 80,1 a 100



de 100,1 a 120

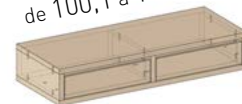

Ref.	CG1316	CG1318	CG1310	CG1312
Puntos	107	127	144	204

Altura 37

hasta 60



de 60,1 a 80



de 80,1 a 100



de 100,1 a 120



Ref.	CG2316	CG2318	CG2310	CG2312
Puntos	159	187	210	308

Altura 52,5

hasta 60



de 60,1 a 80



de 80,1 a 100



de 100,1 a 120



Ref.	CG3316	CG3318	CG3310	CG3312
Puntos	211	247	276	411

Altura 68

hasta 60



de 60,1 a 80



de 80,1 a 100



de 100,1 a 120



Ref.	CG4316	CG4318	CG4310	CG4312
Puntos	263	307	342	516

Altura 83,5

hasta 60



de 60,1 a 80



de 80,1 a 100



de 100,1 a 120



Ref.	CG5316	CG5318	CG5310	CG5312
Puntos	315	367	408	620

Altura 99

hasta 60



de 60,1 a 80



de 80,1 a 100



de 100,1 a 120



Ref.	CG6316	CG6318	CG6310	CG6312
Puntos	367	427	474	724

CAJONERAS FONDO 55

COSTILLA 16

Altura 26,5

hasta 60



de 60,1 a 80



de 80,1 a 100



de 100,1 a 120



Ref.	CG1366	CG1368	CG1360	CG1362
Puntos	111	131	148	212

Altura 47

hasta 60



de 60,1 a 80



de 80,1 a 100



de 100,1 a 120



Ref.	CG2366	CG2368	CG2360	CG2362
Puntos	167	195	218	324

Altura 67,5

hasta 60



de 60,1 a 80



de 80,1 a 100



de 100,1 a 120



Ref.	CG3366	CG3368	CG3360	CG3362
Puntos	223	259	288	436

Altura 88

hasta 60



de 60,1 a 80



de 80,1 a 100



de 100,1 a 120



Ref.	CG4366	CG4368	CG4360	CG4362
Puntos	279	323	358	548

Altura 108,5

hasta 60



de 60,1 a 80



de 80,1 a 100



de 100,1 a 120



Ref.	CG5366	CG5368	CG5360	CG5362
Puntos	335	387	428	660

CAJONERAS PARA COLGAR FONDO 55

COSTILLA 11				COSTILLA 16			
Altura 18,5	hasta 60	de 60,1 a 80	de 80,1 a 100	hasta 60	de 60,1 a 80	de 80,1 a 100	
	Ref. CG156C	CG158C	CG150C	CG166C	CG168C	CG160C	
Puntos	87	101	112	90	104	114	
Altura 34	hasta 60	de 60,1 a 80	de 80,1 a 100	hasta 60	de 60,1 a 80	de 80,1 a 100	
	Ref. CG256C	CG258C	CG250C	CG266C	CG268C	CG260C	
Puntos	137	158	174	143	164	180	

CAJONES SEPARADORES

Incremento por separadores (cajón no incluido)

Altura 18,5	de 60,1 a 80	de 80,1 a 100	de 100,1 a 120
	Ref. CRB685	CRB105	CRB125
Puntos	30	34	42

CASILLERO FONDO 55

Altura 36	de 60,1 a 80	de 80,1 a 100	de 100,1 a 120
	Ref. CS82	CS102	CS122
Puntos	96	120	152

PANTALONEROS FONDO 55

Altura 18,5	hasta 60	de 60,1 a 80	de 80,1 a 100
	Ref. PNT606	PNT686	PNT106
Puntos	150	164	180

CAJONERAS INTERIORES LIBRE COMPOSICIÓN FONDO 55

Disponibles cajones de 11, 16 y 25 cm de alto en costilla.

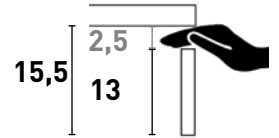

Ancho total de 40 a 60		Ancho total de 60,1 a 80		Ancho total de 80,1 a 100	
Altura Costilla	Altura Total	Altura Costilla	Altura Total	Altura Costilla	Altura Total
11	15,5	11	15,5	11	15,5
16	20,5	16	20,5	16	20,5
22	29,5	22	29,5	22	29,5

Ref.	Puntos	Ref.	Puntos	Ref.	Puntos
CGN316	52	CGN318	60	CGN310	66
CGN366	56	CGN368	64	CGN360	70
CGN356	69	CGN358	77	CGN350	73

El precio de los lados de la cajonera va incluido en cada cajón.

Ancho total de 40 a 60	Ancho total de 60,1 a 80	Ancho total de 80,1 a 100
CFN346	CFN368	CFN380
55	67	78
Tapa y base	Tapa y base	Tapa y base

Seleccionar altura y cantidad de cajones + una tapa (obligatoria), todos del mismo ancho.
Con estas referencias ya podemos crear la cajonera de libre composición.

Ejemplo de cajonera de 40 a 60:

11	CGN316	52	+	CFN346	55	=		3	Altura Tapa
16	CGN366	56						15,5	Altura Costilla 11
16	CGN366	56						20,5	Altura Costilla 16
22	CGN356	69						20,5	Altura Costilla 16
								29,5	Altura Costilla 22
								3	
<p>Puntos Total (52 + 56 + 56 + 69) + 55 288</p>							<p>Altura Total (3 + 15,5 + 20,5 + 20,5 + 29,5 + 3) 92</p>		

ESTRUCTURA

Cajón frente cristal

Costillas laterales acabado único ANTRACITA

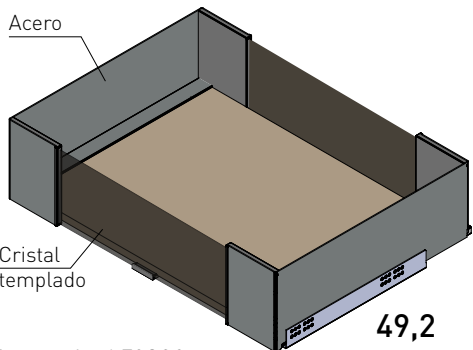

Frente cristal FOSCO

Acabados laminados base cajón

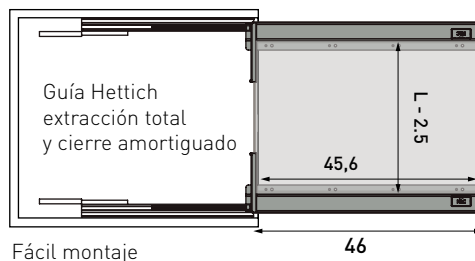
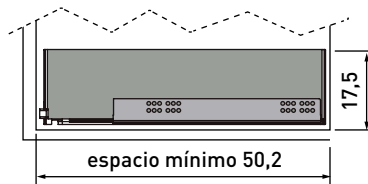

Fácil montaje

L hueco armario	Ref.	Puntos
36-46	CF146	159
46-56	CF156	165
56-66	CF166	168
66-76	CF176	179
76-86	CF186	186
86-96	CF196	192
96-106	CF106	199
106-116	CF116	206

Cajón frente cristal

Costillas laterales acabado único ANTRACITA

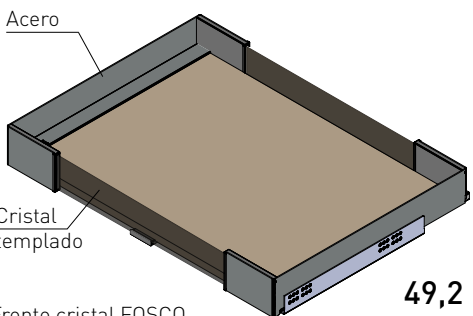

Frente cristal FOSCO

Acabados laminados base cajón

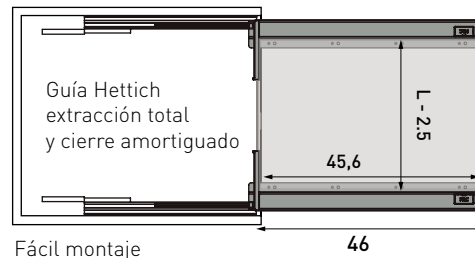
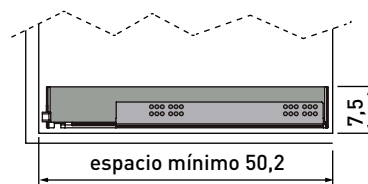

Fácil montaje

L hueco armario	Ref.	Puntos
36-46	CF746	146
46-56	CF756	150
56-66	CF766	154
66-76	CF776	161
76-86	CF786	167
86-96	CF796	174
96-106	CF706	181
106-116	CF716	189

COMPLEMENTOS

Joyero organizador

Acabado TITANIO

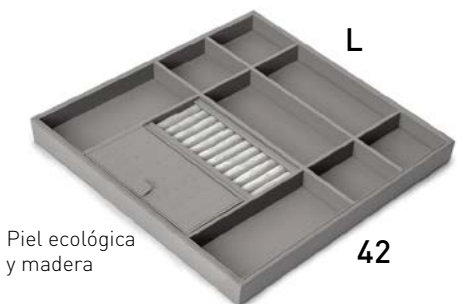

L	Ref.	Puntos
44	JR4	88
54	JR5	100
64	JR6	112
74	JR7	124

Caja accesorios

Acabado único ANTRACITA
Acero

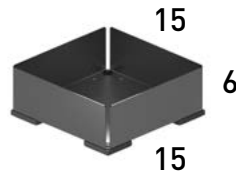

L	Ref.	Puntos
15	CAJ15	24

Bandeja accesorios

Acabado único ANTRACITA
Acero



L	Ref.	Puntos
28	BAN28	28
45	BAN45	30

ESTRUCTURA

Cajón zapatero frente cristal

Costillas laterales acabado único ANTRACITA

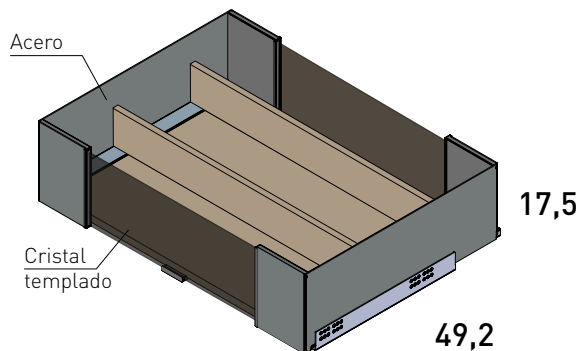

Frente cristal FOSCO

Acabados laminados base cajón

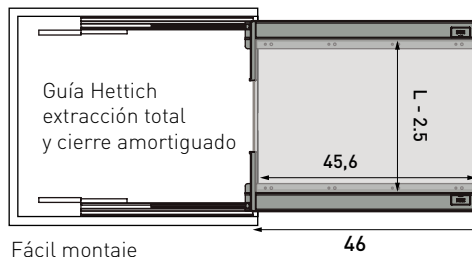
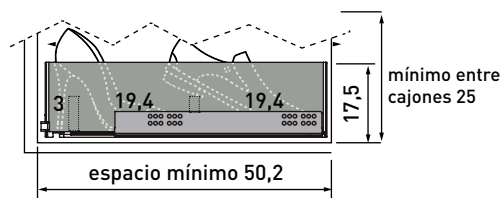

Fácil montaje

L hueco armario	Ref.	Puntos
36-46	CZ46	172
46-56	CZ56	179
56-66	CZ66	187
66-76	CZ76	198
76-86	CZ86	207
86-96	CZ96	214
96-106	CZ06	223
106-116	CZ16	230

COLGADORES

Perchero Abatible

Acabado único ANTRACITA

Acero

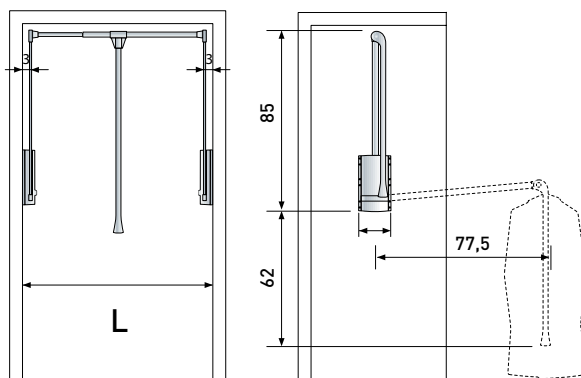
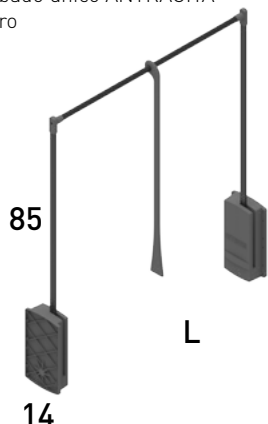

L hueco armario	Ref.	Puntos
44-60	PER4	114
60-90	PER6	130
90-116	PER7	134

Perchero extraíble SUPERIOR

Acabado único ANTRACITA

Acero

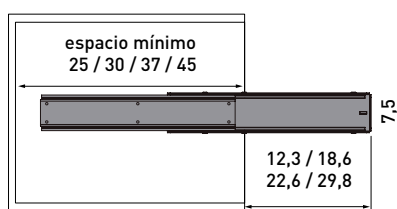

Carga máxima 15kg
Necesita estante superior

P	Ref.	Puntos
24	PEX24	44
29	PEX29	46
36	PEX36	48
44	PEX44	50

Barras colgar

Acabado ANTRACITA
Aluminio

Perfil superior minimiza ruido

Barra rectangular con 2 soportes de fijación a costado o estante

Necesita estante superior

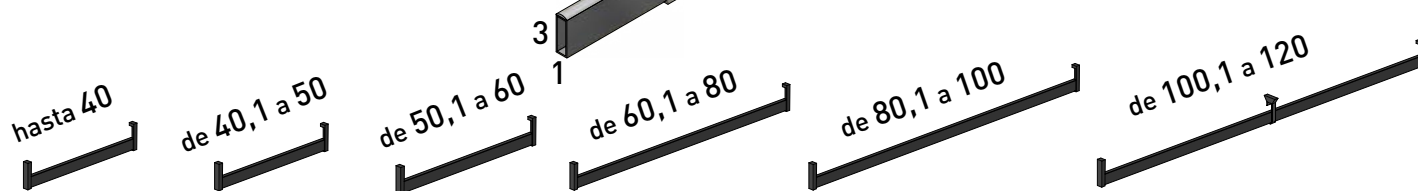

Ref.	BL40	BL50	BL60	BL80	BL10	BL12
Puntos	18	21	25	27	30	38

ACCESORIOS

Zapatero lateral extraíble

Acabado único ANTRACITA
Acero

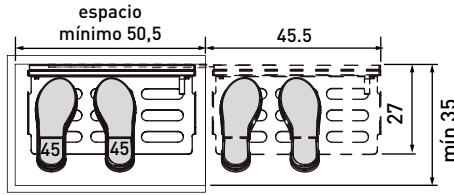
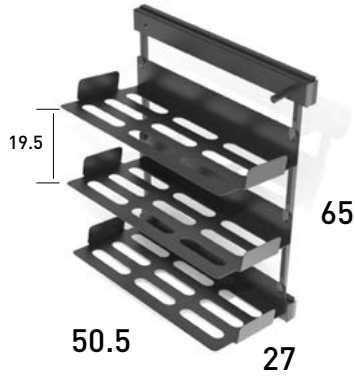

L	Ref.	Puntos
DR	Z65DS	184
IZ	Z65ZS	184

Cesta de tela

Estructura ANTRACITA
Acero / Tela gris

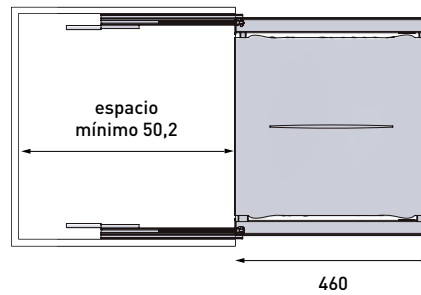

L	Ref.	Puntos
49,5-54,5	CET5S	214
54,5-59,5	CET6S	222

Corbatero lateral extraíble

Acabado único ANTRACITA
Acero

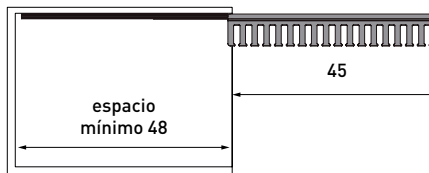
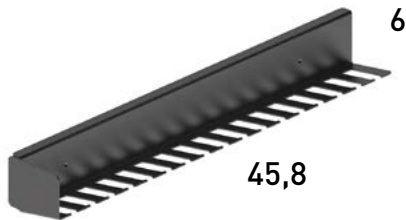

L	Ref.	Puntos
DR	COSD	53
IZ	COSZ	53

Espejo lateral extraíble

Acabado único GRAFITO

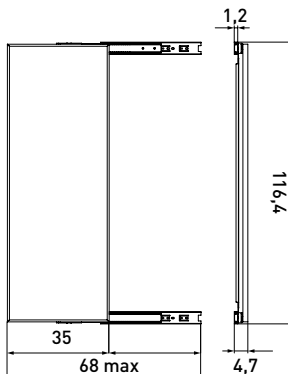
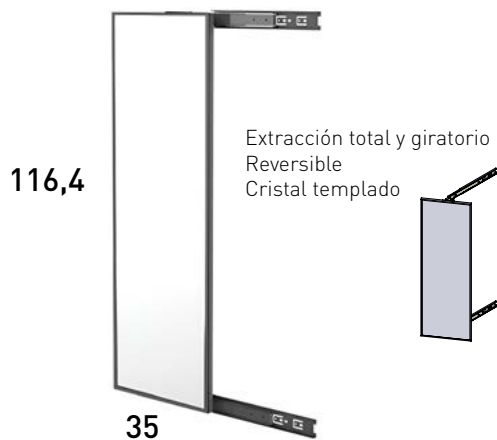

L	Ref.	Puntos
35	ESPES	78

PANTALONEROS

Guía Hettich extracción total y cierre amortiguado
Soportes con funda antideslizante

Bandeja pantalonero

Acabado único ANTRACITA
Acero

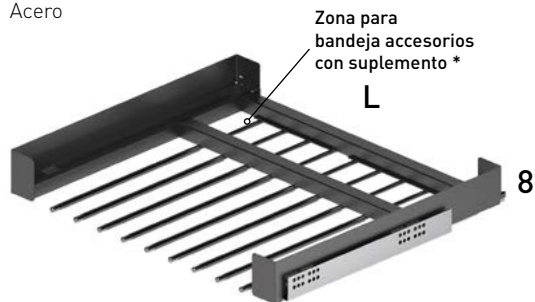

Carga máxima 30kg

49

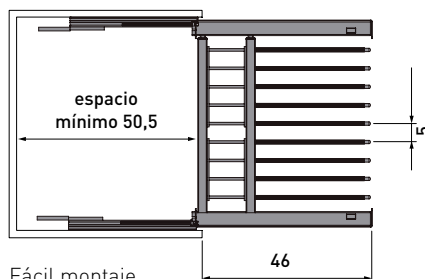

Fácil montaje

Soportes	L	Ref.	Puntos
7-9	46,5-56,5	PAX60S	192
9-11	56,5-66,5	PAX70S	198
11-13	66,5-76,5	PAX80S	207
13-15	76,5-86,5	PAX90S	215

Bandeja accesorios

Acabado único ANTRACITA



* Bandejas recomendadas según medida
de 46,5 a 61,5 cm 1 unidad
de 61,5 a 81,5 cm 2 unidades
de 81,5 a 86,5 cm 3 unidades

Ref.	Puntos
BDA24	14

Pantalonero extraíble LATERAL

Acabado único ANTRACITA
Acero

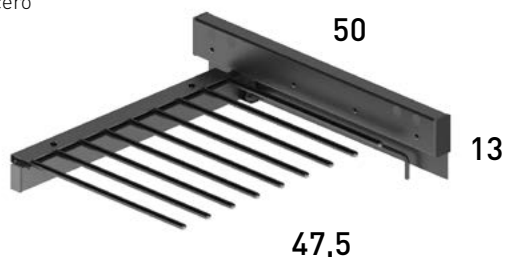

Reversible
Para 9 pantalones

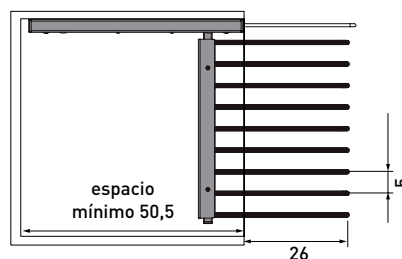

Ref.	Puntos
PAXS	121

Pantalonero extraíble SUPERIOR

Acabado único ANTRACITA
Acero

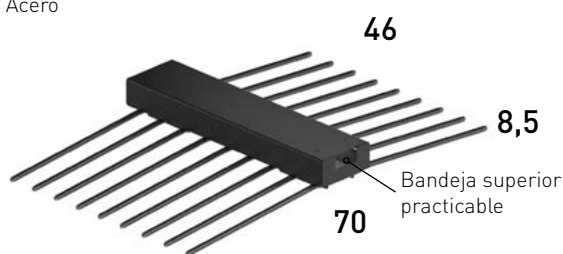

Para 18 pantalones.
Necesita estante superior

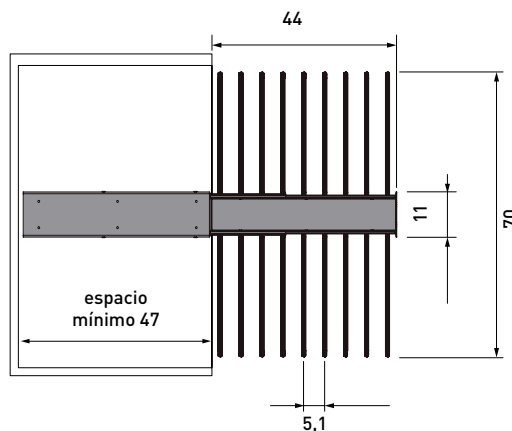

Ref.	Puntos
PAX18	148

Pantalonero extraíble SUPERIOR

Acabado único ANTRACITA
Acero

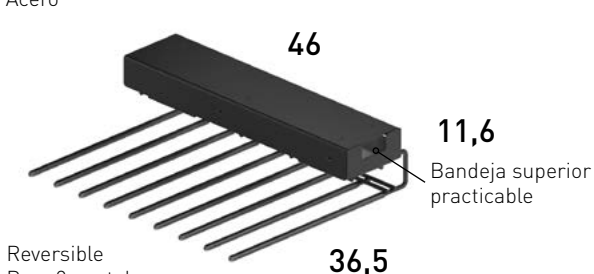

Reversible
Para 9 pantalones
Necesita estante superior

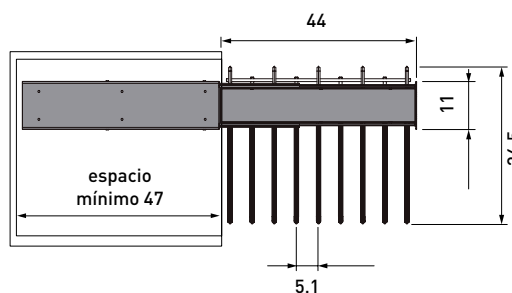

Ref.	Puntos
PAX9	112



Estructuras para interiores de armario
(Interiores no regulables en altura)



Columnas aluminio

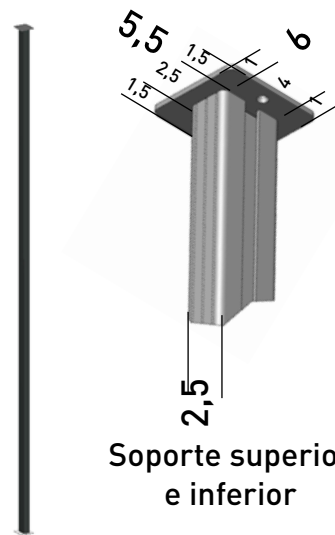

Altura	Ref.	Puntos
150 - 200	CAL1	86
201 - 274	CAL2	96

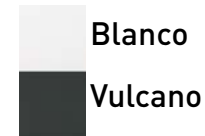

Soporte superior e inferior

Estos estantes no tienen mano.



ESTANTES FONDO 55

Grueso 3

hasta 40



1 soporte incluido + 2 soportes UX

de 40,1 a 50



1 soporte incluido + 2 soportes UX

de 50,1 a 60



1 soporte incluido + 2 soportes UX

Ref.	ET94	ET95	ET96
Puntos	37	40	44

Grueso 3

de 60,1 a 80



1 soporte incluido + 2 soportes UX

de 80,1 a 100



1 soporte incluido + 2 soportes UX

de 100,1 a 120

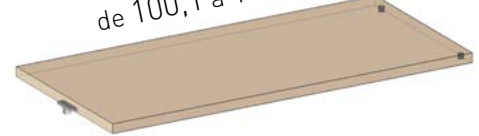

1 soporte incluido + 2 soportes UX

Ref.	ET98	ET90	ET92
Puntos	47	49	54



ESTANTES EXTRAIBLE FONDO 55

No tiene mano
Soportes incluidos

Grosor 3

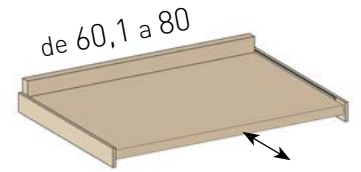
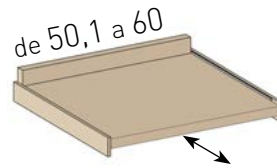
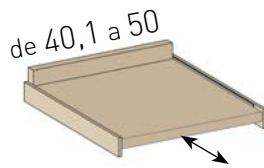
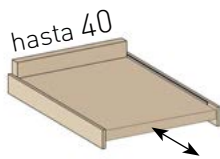

Ref.	ETX44	ETX54	ETX64	ETX84
Puntos	69	72	76	79

ESTANTES CRISTAL FONDO 55

No tiene mano
Soportes incluidos

Grosor 0.6

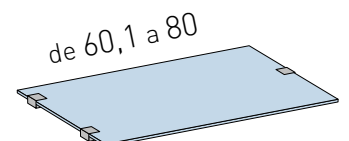
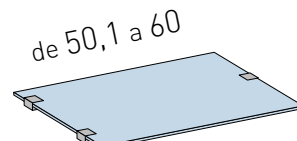
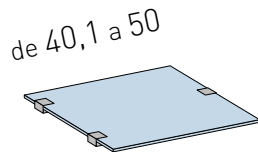
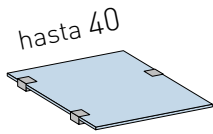

Ref.	EV44	EV54	EV64	EV84
Puntos	66	74	82	99

Grosor 0.6

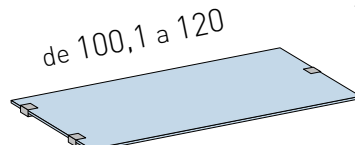
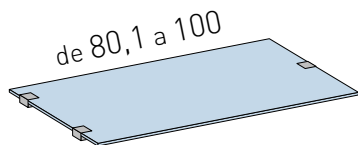

Acabados cristal
transparente y opaco



Acabados soporte
estante cristal



Ref.	EV104	EV124
Puntos	126	142

ZAPATERO FIJO FONDO 55

Soportes incluidos

Grosor 3

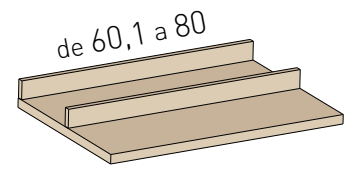
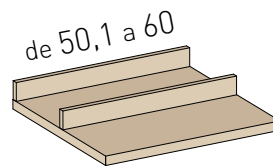
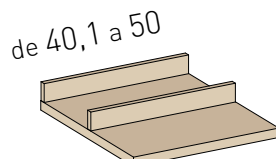
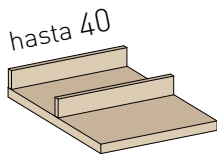

	izquierda	derecha	izquierda	derecha	izquierda	derecha	izquierda	derecha
Ref.	EZ44Z	EZ44D	EZ54Z	EZ54D	EZ64Z	EZ64D	EZ84Z	EZ84D
Puntos	49	49	53	53	57	57	62	62

Grosor 3

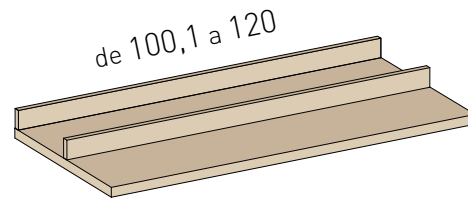
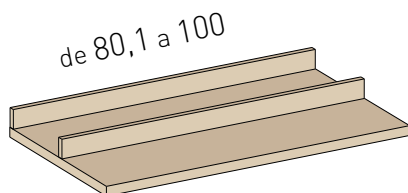

	izquierda	derecha	izquierda	derecha
Ref.	EZ104Z	EZ104D	EZ124Z	EZ124D
Puntos	65	65	71	71



ZAPATERO EXTRAÍBLE FONDO 55

Grosor 3

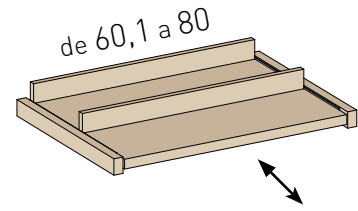
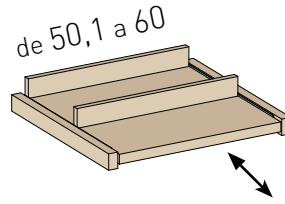
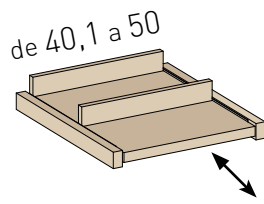
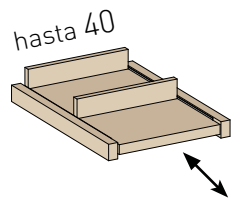

No tiene mano
Soportes incluidos

Ref.	EX44	EX54	EX64	EX84
Puntos	71	75	80	84

BARRAS

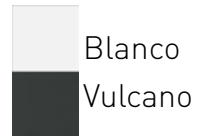
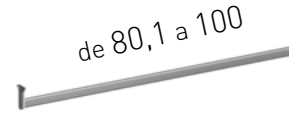
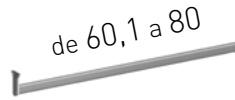
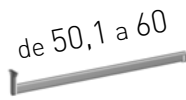

No tiene mano
Soportes incluidos

Cada barra incorpora un juego de dos soportes.

Ref.	BC45	BC56	BC68	BC100
Puntos	27	30	33	41

CAJONERAS FONDO 55

Para cajón separador pag 246

Altura 21,5



Costilla de 11
No tiene mano
Soportes incluidos

Ref.	CG163	CG183	CG103
Puntos	114	134	152

Altura 37



Ref.	CG263	CG283	CG203
Puntos	166	195	218

PANTALONEROS FONDO 55

Altura 18,5

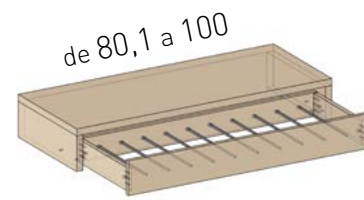
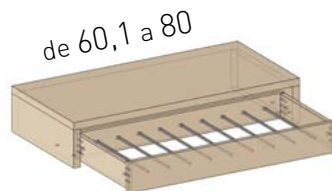
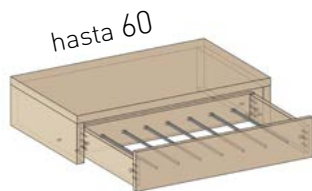

No tiene mano
Soportes incluidos

Ref.	PNT607	PNT687	PNT107
Puntos	162	182	198



COLUMNAS FONDO 56

Lado izquierdo

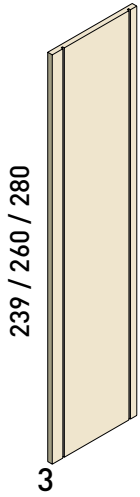

Altura	Ref.	Puntos
239	CLZ24R	138
260	CLZ26R	146
280	CLZ28R	150

Mecanizado lado derecho

Parte central

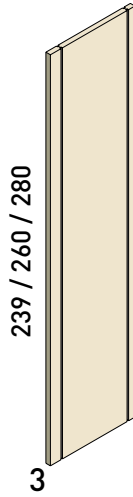

Altura	Ref.	Puntos
239	CLC24R	197
260	CLC26R	206
280	CLC28R	210

Mecanizado dos lados

Lado derecho



Altura	Ref.	Puntos
239	CLD24R	138
260	CLD26R	146
280	CLD28R	150

Mecanizado lado izquierdo

BUCS FONDO 56

Buc superior e inferior

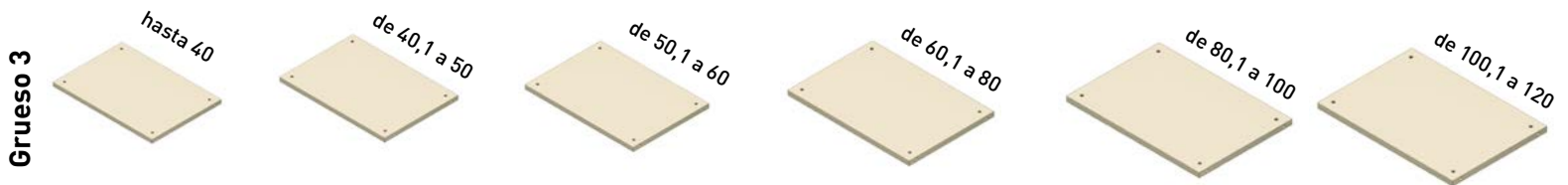

Ref.	BU24R	BU25R	BU26R	BU28R	BU210R	BU212R
Puntos	22	25	29	32	34	39

BUC / ESTANTE RINCÓN

Grueso 3

Buc de 100 a 120 de 100 a 120

Estante de 100 a 120 de 100 a 120

* Incluye 5 soportes

Blanco Vulcano

* Obligatorio un estante superior

Barra rectangular con 4 soportes de fijación a costado o estante. Perfil superior minimiza ruido

Barra rincón de 100 a 120 de 100 a 120

Blanco Vulcano

Ref.	BUR7R	ER55R	BNR
Puntos	96	116	53

TAPETA RINCÓN



Altura	Ref.	Puntos
239	TR240R	65
260	TR260R	69
280	TR280R	73

ESTANTES FONDO 55

* Incluye 4 soportes

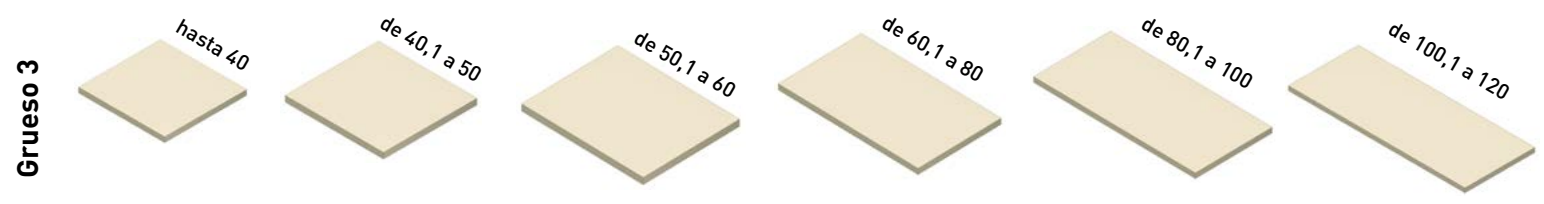
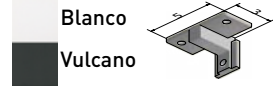

Ref.	ET84R	ET85R	ET86R	ET88R	ET80R	ET82R
Puntos	36	39	43	46	48	53

ESTANTES EXTRAIBLES FONDO 55

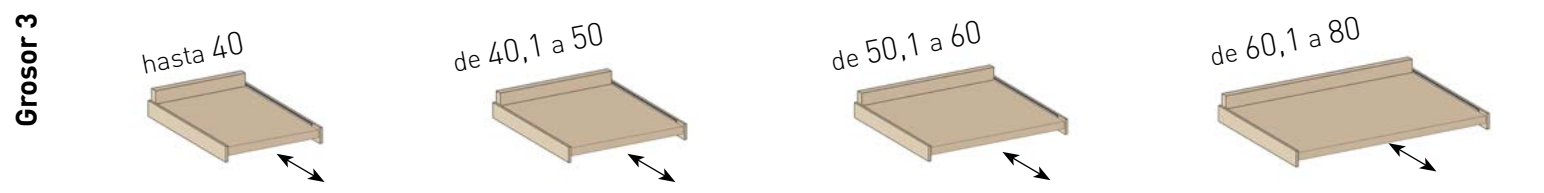

Ref.	ETT84R	ETT85R	ETT86R	ETT88R
Puntos	68	71	75	79

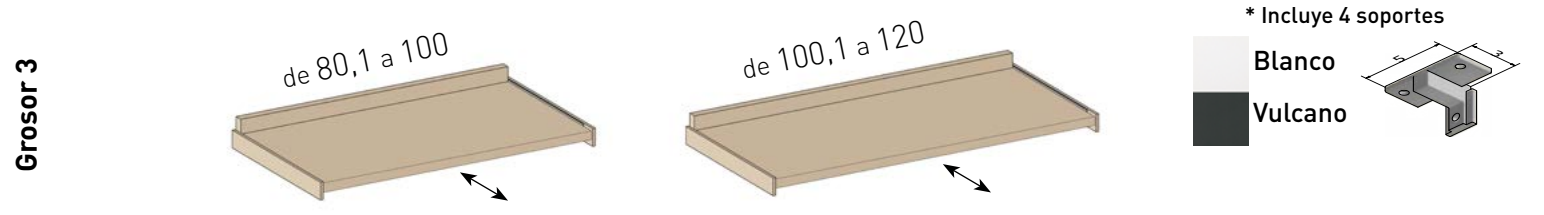

* Incluye 4 soportes

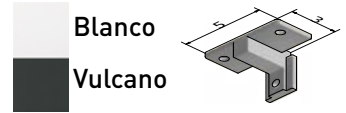

Ref.	ETT80R	ETT82R
Puntos	80	85

ESTANTES CRISTAL FONDO 55

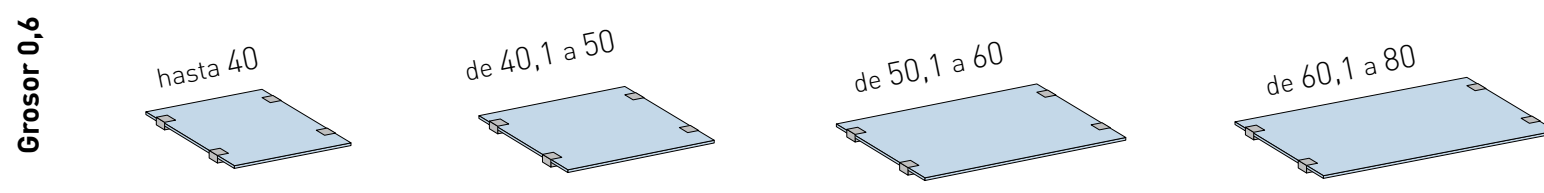

Ref.	EV43R	EV53R	EV63R	EV83R
Puntos	76	84	92	108

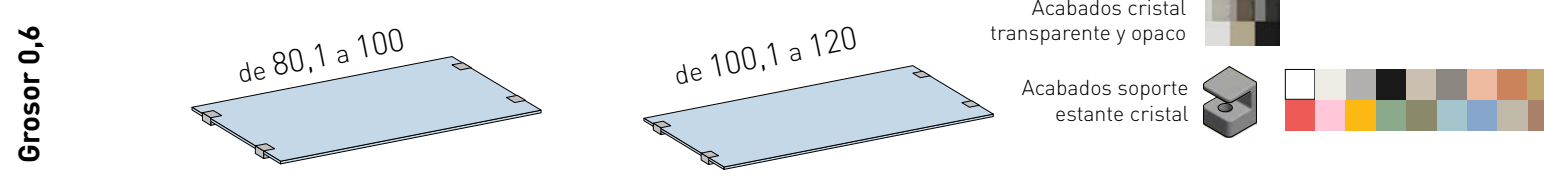

Acabados cristal transparente y opaco

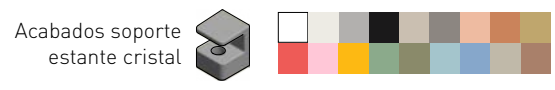

Ref.	EV103R	EV123R
Puntos	126	152

BARRAS

Blanco
Vulcano

* Obligatorio un estante superior

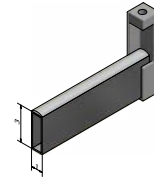

Barra rectangular con 2 soportes de fijación a estante. Perfil superior minimiza ruido

hasta 40



de 40,1 a 50

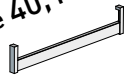

de 50,1 a 60

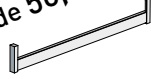

de 60,1 a 80

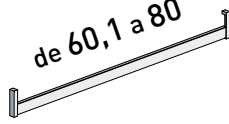

de 80,1 a 100

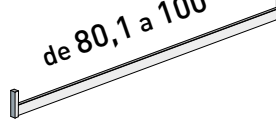

de 100,1 a 120

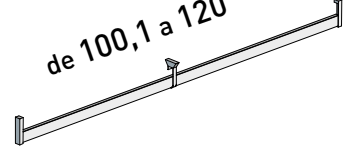

Incorpora 3 soportes.

Ref.	BC4R	BC5R	BC6R	BC8R	BC10R	BC12R
Puntos	18	21	24	27	30	37

ZAPATERO FIJO FONDO 55

Grosor 3

hasta 40

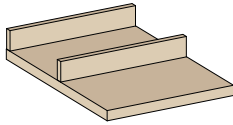

de 40,1 a 50

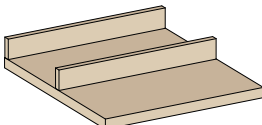

de 50,1 a 60

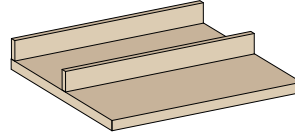

de 60,1 a 80

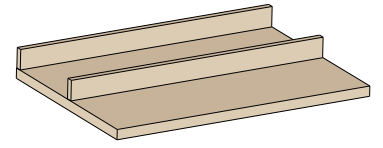

Ref.	EZ43R	EZ53R	EZ63R	EZ83R
Puntos	48	52	57	61

Grosor 3

de 80,1 a 100

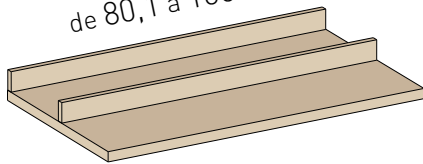

de 100,1 a 120

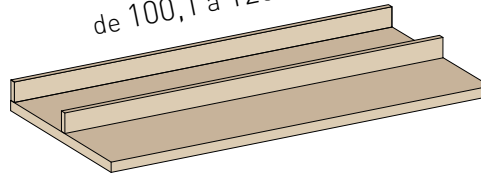

* Incluye 4 soportes

Blanco
Vulcano

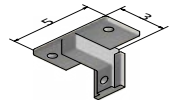

Ref.	EZ103R	EZ123R
Puntos	64	70

ZAPATERO EXTRAÍBLE FONDO 55

Grosor 3

hasta 40

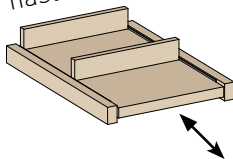

de 40,1 a 50

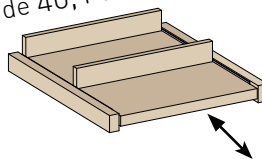

de 50,1 a 60

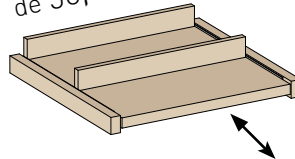

de 60,1 a 80

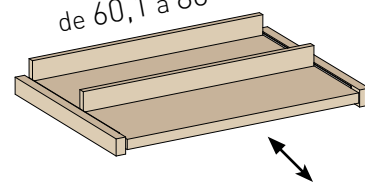

Ref.	EX43R	EX53R	EX63R	EX83R
Puntos	73	77	82	86

Grosor 3

de 80,1 a 100

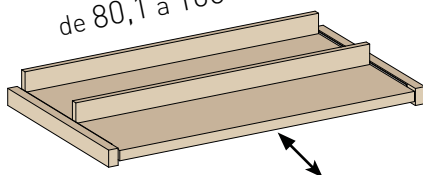

de 100,1 a 120

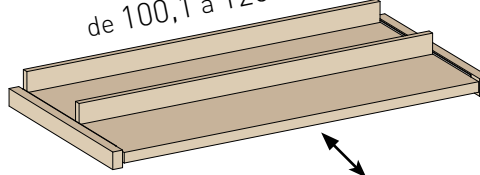

* Incluye 4 soportes

Blanco
Vulcano

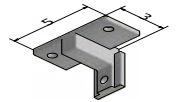

Ref.	EX103R	EX123R
Puntos	89	95

PARTIDORES FONDO 55

* Por defecto incluye Rail System por ambos lados

Grosor 3

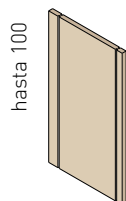

hasta 100

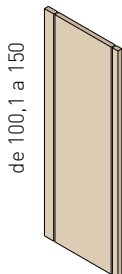

de 100,1 a 150

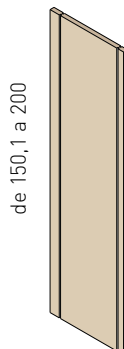

de 150,1 a 200

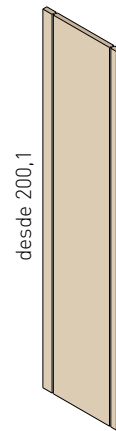

desde 200,1

Ref.	DNT103R	DNT153R	DNT203R	DNT303R
Puntos	94	124	163	174

PARTIDORES ALUMINIO

Grosor 3

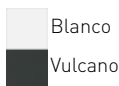

* Compatible solo con cajoneras colgadas

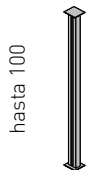

hasta 100

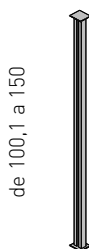

de 100,1 a 150



de 150,1 a 200



desde 200,1

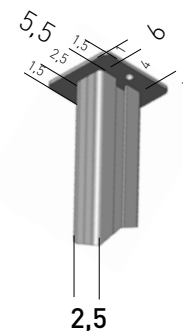

Soporte superior e inferior

Ref.	CAL10	CAL15	CAL20	CAL30
Puntos	46	52	86	96

OPCIONES

Zapatero extensible y extraible

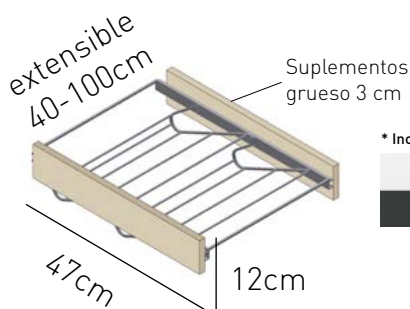

Barra abatible y extensible

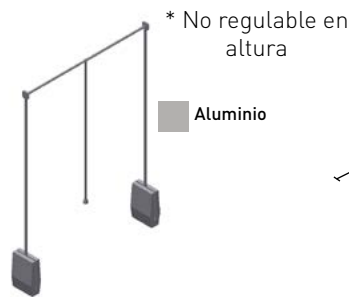

60cm mín / 115cm máx

Mesa planchar plegable

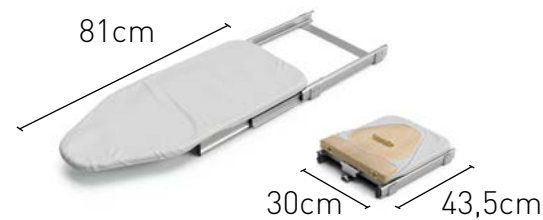

Precisa de un estante de soporte.

Ref.	ZPR3	BRT	TPL
Puntos	105	110	168

LEDS

*Sensor movimiento incorporado

1 tira de led



2 tiras de leds



Ref.	LED10	LED20
Puntos	168	288

CAJONERAS FONDO 55

COSTILLA 11

* Incluye 4 soportes

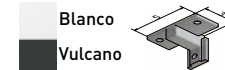

Altura 21,5

hasta 40



de 40,1 a 60



de 60,1 a 80



de 80,1 a 100



de 100,1 a 120



Ref.	CG1314R	CG1316R	CG1318R	CG1310R	CG1312R
Puntos	115	131	151	168	228

Altura 37

hasta 40



de 40,1 a 60



de 60,1 a 80



de 80,1 a 100



de 100,1 a 120



Ref.	CG2314R	CG2316R	CG2318R	CG2310R	CG2312R
Puntos	165	183	211	234	332

Altura 52,5

hasta 40



de 40,1 a 60



de 60,1 a 80



de 80,1 a 100



Ref.	CG3314R	CG3316R	CG3318R	CG3310R
Puntos	215	235	271	300

Altura 68

hasta 40



de 40,1 a 60



de 60,1 a 80



de 80,1 a 100



Ref.	CG4314R	CG4316R	CG4318R	CG4310R
Puntos	265	287	331	366

* Incluye 4 soportes

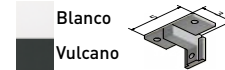

PANTALONEROS FONDO 55

Altura 18,5

hasta 60



de 60,1 a 80

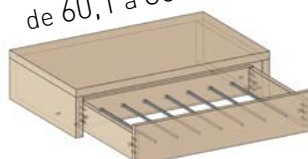

de 80,1 a 100

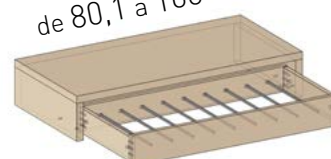

Ref.	PNT606R	PNT686R	PNT106R
Puntos	174	188	204

CAJONERAS FONDO 55

COSTILLA 16

* Incluye 4 soportes

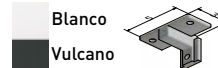

Altura 26,5	hasta 40	de 40,1 a 60	de 60,1 a 80	de 80,1 a 100	de 100,1 a 120
Ref.	CG1364R	CG1366R	CG1368R	CG1360R	CG1362R
Puntos	120	135	155	172	236

Altura 47	hasta 40	de 40,1 a 60	de 60,1 a 80	de 80,1 a 100	de 100,1 a 120
Ref.	CG2364R	CG2366R	CG2368R	CG2360R	CG2362R
Puntos	170	191	219	242	348

Altura 67,5	hasta 40	de 40,1 a 60	de 60,1 a 80	de 80,1 a 100
Ref.	CG3364R	CG3366R	CG3368R	CG3360R
Puntos	225	247	283	312

SEPARADORES CAJONES

Incremento por separadores (cajón no incluido)

Altura 18,5	hasta 60	de 60,1 a 80	de 80,1 a 100	de 100,1 a 120
Ref.	CRB665R	CRB685R	CRB105R	CRB125R
Puntos	24	30	34	42

CASILLERO FONDO 55

* Incluye 4 soportes

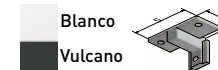

Altura 36	de 60,1 a 80	de 80,1 a 100	de 100,1 a 120
Ref.	CS82R	CS102R	CS122R
Puntos	120	144	176

CAJONERAS LIBRE COMPOSICIÓN FONDO 55

Disponibles cajones de 11 y 16 cm de alto en costilla.

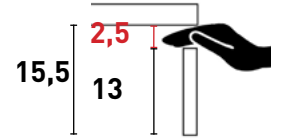

Ancho total de 40 a 60		Ancho total de 60,1 a 80		Ancho total de 80,1 a 100	
Altura Costilla	Altura Total	Altura Costilla	Altura Total	Altura Costilla	Altura Total
11	15,5	11	15,5	11	15,5
16	20,5	16	20,5	16	20,5
Ref.	Puntos	Ref.	Puntos	Ref.	Puntos
CGN316R	52	CGN318R	60	CGN310R	66
CGN366R	56	CGN368R	64	CGN360R	70

El precio de los lados de la cajonera va incluido en cada cajon.

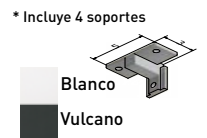

Ancho total de 40 a 60	Ancho total de 60,1 a 80	Ancho total de 80,1 a 100
Ref.	Ref.	Ref.
Puntos	Puntos	Puntos
CFN346R	CFN368R	CFN380R
79	92	102
Tapa y base	Tapa y base	Tapa y base

Seleccionar altura y cantidad de cajones + una tapa (obligatoria), todos del mismo ancho. Con estas referencias ya podemos crear la cajonera de libre composición.

Ejemplo de cajonera de 40 a 60:

11		CGN316R	52	+		=		3	Altura frente + espacio entre cajones	
16		CGN366R	56						3	Altura Tapa
16		CGN366R	56						15,5	Altura Costilla 11
									20,5	Altura Costilla 16
								20,5	Altura Costilla 16	
								3	Altura Tapa	
								Puntos Total		
								(52 + 56 + 56) + 79		
								243		
								Altura Total		
								(3 + 15,5 + 20,5 + 20,5 + 3)		
								62,5		



COLUMNAS FONDO 58

Lado izquierdo

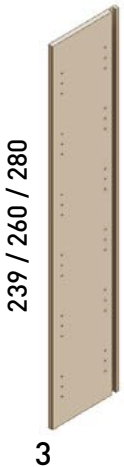

Altura	Ref.	Puntos
239	CLZ44	85
260	CLZ46	93
280	CLZ48	97

Mecanizado lado derecho

Parte central



Altura	Ref.	Puntos
239	CLC44	89
260	CLC46	98
280	CLC48	102

Mecanizado dos lados

Lado derecho



Altura	Ref.	Puntos
239	CLD44	85
260	CLD46	93
280	CLD48	97

Mecanizado lado izquierdo

BUCS FONDO 58

Buc superior e inferior con ranura

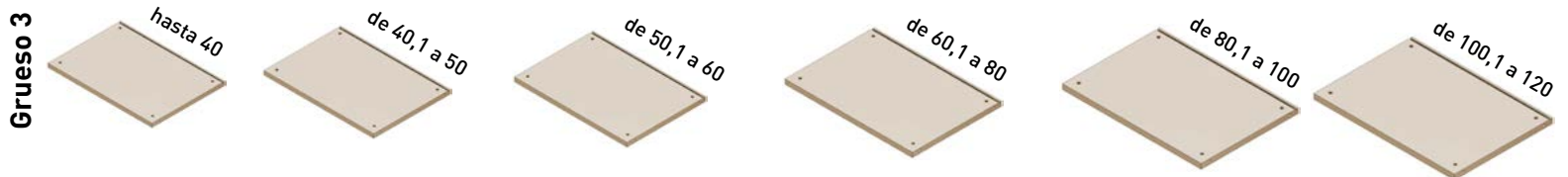

Ref.	BU44	BU45	BU46	BU48	BU410	BU412
Puntos	23	26	30	33	35	40

TRASERAS

Grosor 1

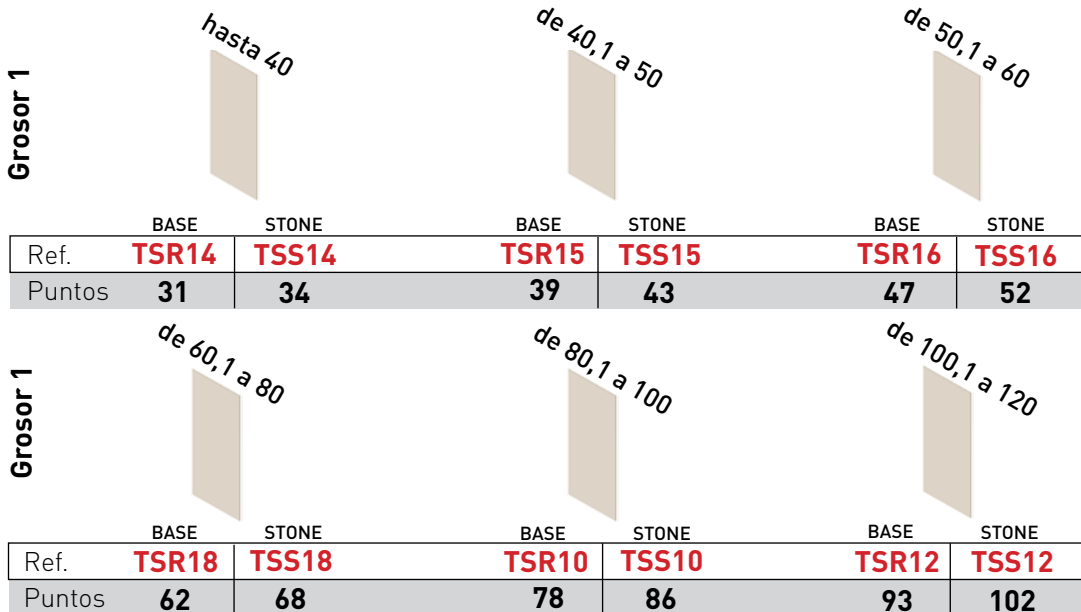

Ref.	BASE		STONE		Ref.	BASE		STONE		Ref.	BASE		STONE	
	TSR14	TSS14	TSR15	TSS15		TSR16	TSS16	TSR18	TSS18		TSR10	TSS10	TSR12	TSS12
Puntos	31	34	39	43	47	52	62	68	78	86	93	102		

MOLDURA RINCÓN

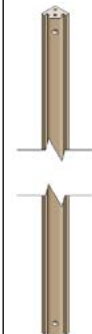

Altura	Ref.	Puntos
239	ML239	47
260	ML260	52
280	ML280	57

BUC / ESTANTE RINCÓN

Grosor 3

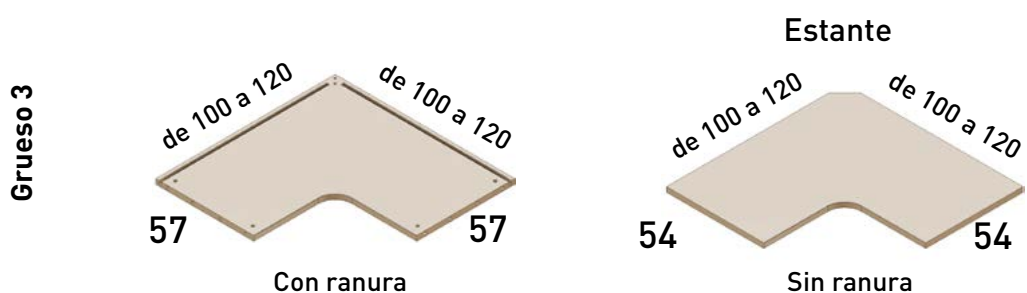

Con ranura

Sin ranura

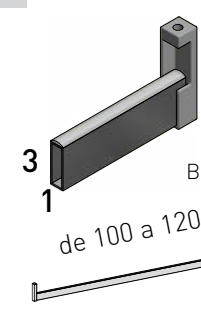

Barra rincón

Barra rectangular con 4 soportes de fijación a costado o estante. Perfil superior minimiza ruido

de 100 a 120

de 100 a 120

Blanco

Vulcano

Ref.	BUR8	ER54	BN
Puntos	96	96	50

ESTANTES FONDO 55

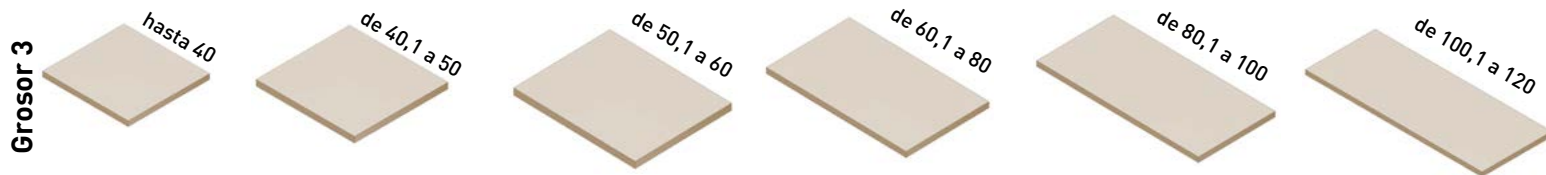

Ref.	ET84	ET85	ET86	ET88	ET80	ET82
Puntos	22	25	29	32	34	39

ESTANTES EXTRAIBLES FONDO 55



Ref.	ETT84	ETT85	ETT86	ETT88
Puntos	54	57	61	64

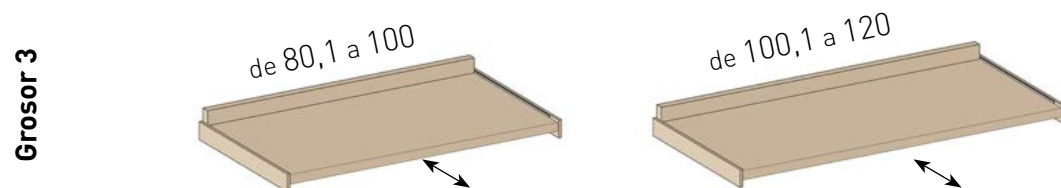

Ref.	ETT80	ETT82
Puntos	66	71

BARRAS

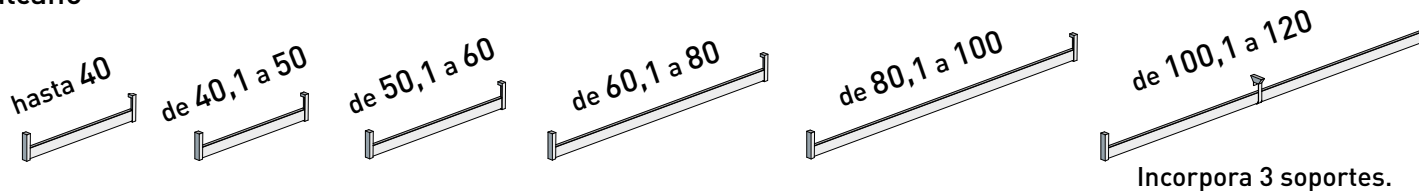
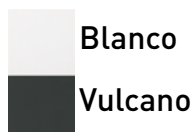

Ref.	BC4	BC5	BC6	BC8	BC10	BC12
Puntos	16	19	22	25	28	35

ESTANTES CRISTAL FONDO 55

Grosor 0.6

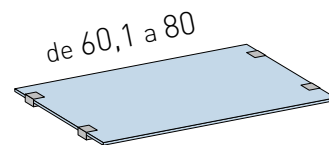
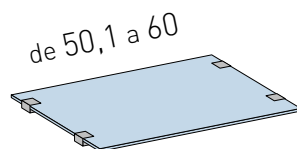
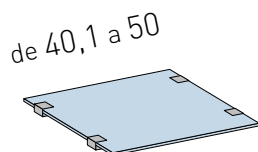
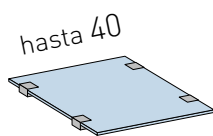

Ref.	EV43	EV53	EV63	EV83
Puntos	54	62	70	87

Grosor 0.6

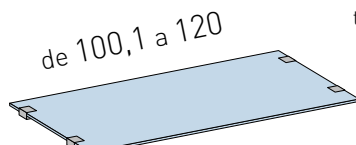
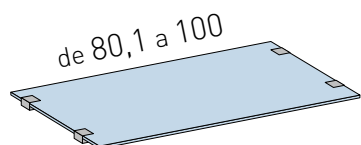

Acabados cristal transparente y opaco

Acabados soporte estante cristal

Ref.	EV103	EV123
Puntos	114	130

PARTIDORES FONDO 55

Grosor 3



Ref.	DNT103	DNT153	DNT203	DNT303
Puntos	49	54	58	64

ZAPATERO FIJO FONDO 55

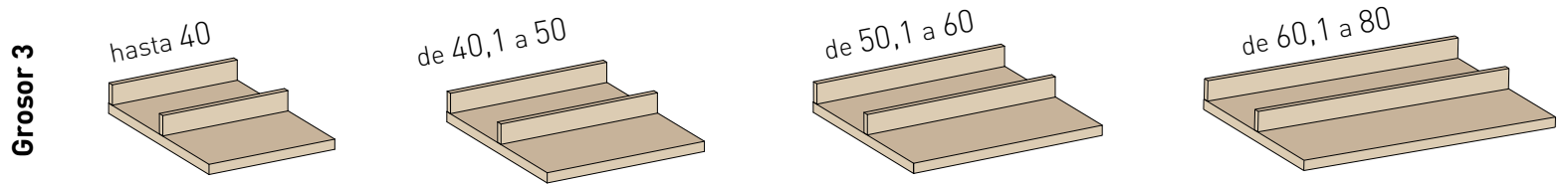

Ref.	EZ43	EZ53	EZ63	EZ83
Puntos	34	38	43	47

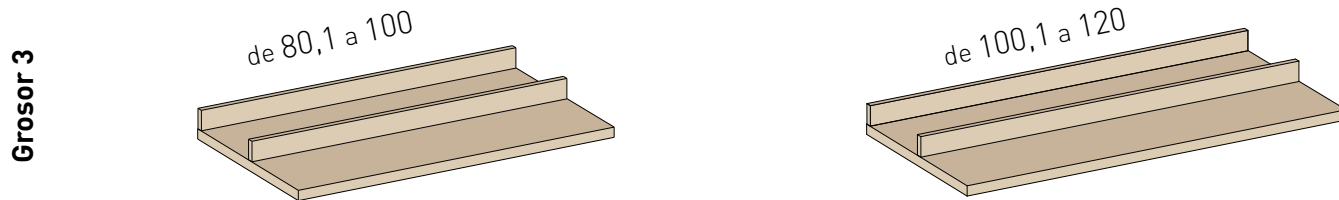

Ref.	EZ103	EZ123
Puntos	50	56

ZAPATERO EXTRAÍBLE FONDO 55

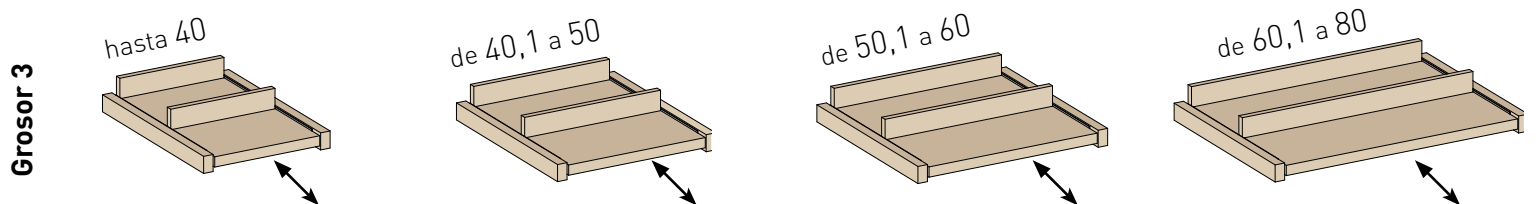

Ref.	EX43	EX53	EX63	EX83
Puntos	59	63	68	72

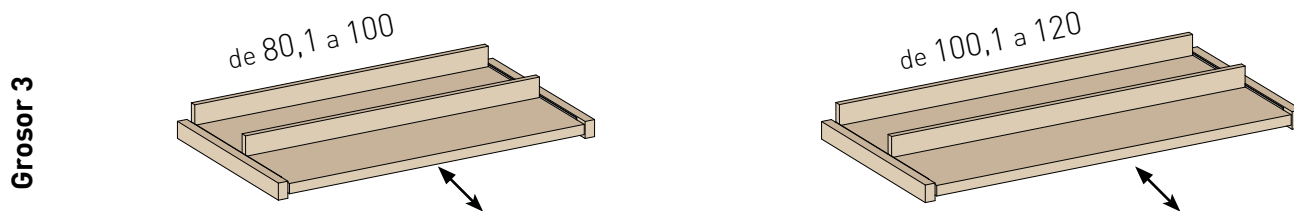

Ref.	EX103	EX123
Puntos	75	81

* Medidas especiales de fondo consultar con fábrica

ZAPATERO INCLINADO FONDO 55

Grosor 3

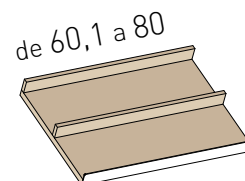
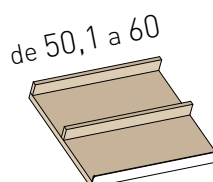
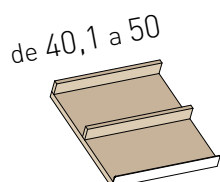

Ref.	EN43	EN53	EN63	EN83
Puntos	40	44	49	53

Grosor 3

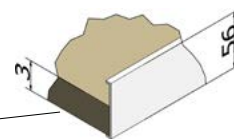
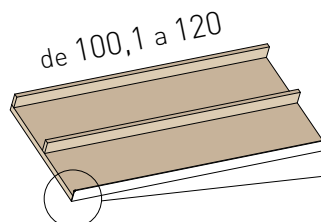
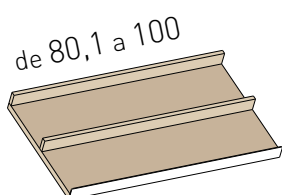

Perfil metálico frontal



Ref.	EN103	EN123
Puntos	56	62

OPCIONES

Zapatero extensible y extraíble

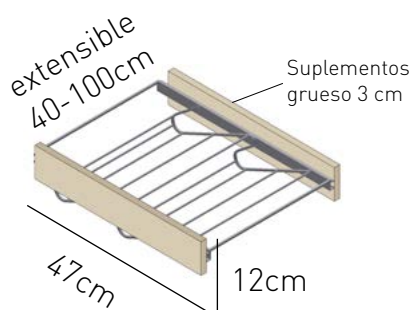

Barra abatible y extensible

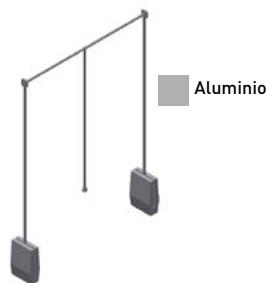

60cm mín / 115cm máx

Mesa planchar plegable

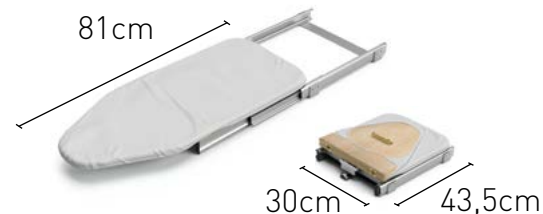

Precisa de un estante de soporte.

Ref.	ZPR	BRT	TPL
Puntos	100	110	168

LEDS

*Sensor movimiento incorporado

1 tira de led



2 tiras de leds



Ref.	LED10	LED20
Puntos	168	288

COSTILLA 11

Altura 21,5

hasta 60



de 60,1 a 80



de 80,1 a 100



de 100,1 a 120



Ref.	CG1316	CG1318	CG1310	CG1312
Puntos	107	127	144	204

Altura 37

hasta 60



de 60,1 a 80



de 80,1 a 100



de 100,1 a 120



Ref.	CG2316	CG2318	CG2310	CG2312
Puntos	159	187	210	308

Altura 52,5

hasta 60



de 60,1 a 80



de 80,1 a 100



de 100,1 a 120



Ref.	CG3316	CG3318	CG3310	CG3312
Puntos	211	247	276	411

Altura 68

hasta 60



de 60,1 a 80



de 80,1 a 100



de 100,1 a 120



Ref.	CG4316	CG4318	CG4310	CG4312
Puntos	263	307	342	516

Altura 83,5

hasta 60



de 60,1 a 80



de 80,1 a 100



de 100,1 a 120



Ref.	CG5316	CG5318	CG5310	CG5312
Puntos	315	367	408	620

Altura 99

hasta 60



de 60,1 a 80



de 80,1 a 100



de 100,1 a 120



Ref.	CG6316	CG6318	CG6310	CG6312
Puntos	367	427	474	724

CAJONERAS FONDO 55

COSTILLA 16

Altura 26,5

hasta 60



de 60,1 a 80



de 80,1 a 100



de 100,1 a 120



Ref.	CG1366	CG1368	CG1360	CG1362
Puntos	111	131	148	212

Altura 47

hasta 60



de 60,1 a 80



de 80,1 a 100



de 100,1 a 120



Ref.	CG2366	CG2368	CG2360	CG2362
Puntos	167	195	218	324

Altura 67,5

hasta 60



de 60,1 a 80



de 80,1 a 100



de 100,1 a 120



Ref.	CG3366	CG3368	CG3360	CG3362
Puntos	223	259	288	436

Altura 88

hasta 60



de 60,1 a 80



de 80,1 a 100



de 100,1 a 120



Ref.	CG4366	CG4368	CG4360	CG4362
Puntos	279	323	358	548

Altura 108,5

hasta 60



de 60,1 a 80



de 80,1 a 100



de 100,1 a 120



Ref.	CG5366	CG5368	CG5360	CG5362
Puntos	335	387	428	660

CAJONERAS PARA COLGAR FONDO 55

COSTILLA 11				COSTILLA 16			
Altura 18,5	hasta 60	de 60,1 a 80	de 80,1 a 100	hasta 60	de 60,1 a 80	de 80,1 a 100	
Ref.	CG156C	CG158C	CG150C	CG166C	CG168C	CG160C	
Puntos	87	101	112	90	104	114	
Altura 34	hasta 60	de 60,1 a 80	de 80,1 a 100	hasta 60	de 60,1 a 80	de 80,1 a 100	
Ref.	CG256C	CG258C	CG250C	CG266C	CG268C	CG260C	
Puntos	137	158	174	143	164	180	

CAJONES SEPARADORES

Incremento por separadores (Cajón no incluido)

Altura 18,5	de 60,1 a 80	de 80,1 a 100	de 100,1 a 120
Ref.	CRB685	CRB105	CRB125
Puntos	30	34	42

CASILLERO FONDO 55

Altura 36	de 60,1 a 80	de 80,1 a 100	de 100,1 a 120
Ref.	CS82	CS102	CS122
Puntos	96	120	152

PANTALONEROS FONDO 55

Altura 18,5	hasta 60	de 60,1 a 80	de 80,1 a 100
Ref.	PNT606	PNT686	PNT106
Puntos	150	164	180

CAJONERAS INTERIORES LIBRE COMPOSICIÓN FONDO 55

Disponibles cajones de 11, 16 y 25 cm de alto en costilla.

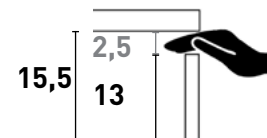

Ancho total de 40 a 60		Ancho total de 60,1 a 80		Ancho total de 80,1 a 100	
Altura Costilla	Altura Total	Altura Costilla	Altura Total	Altura Costilla	Altura Total
11	15,5	11	15,5	11	15,5
16	20,5	16	20,5	16	20,5
22	29,5	22	29,5	22	29,5

Ref.	Puntos	Ref.	Puntos	Ref.	Puntos
CGN316	52	CGN318	60	CGN310	66
CGN366	56	CGN368	64	CGN360	70
CGN356	69	CGN358	77	CGN350	73

El precio de los lados de la cajonera va incluido en cada cajón.

Ancho total de 40 a 60	Ancho total de 60,1 a 80	Ancho total de 80,1 a 100
Tapa y base	Tapa y base	Tapa y base
Ref. CFN346	Ref. CFN368	Ref. CFN380
Puntos 55	Puntos 67	Puntos 78

Seleccionar altura y cantidad de cajones + una tapa (obligatoria), todos del mismo ancho.
Con estas referencias ya podemos crear la cajonera de libre composición.

Ejemplo de cajonera de 40 a 60:

11	CGN316	52	+	CFN346	55	=		Altura frente + espacio entre cajones	
16	CGN366	56						3	Altura Tapa
16	CGN366	56						15,5	Altura Costilla 11
22	CGN356	69						20,5	Altura Costilla 16
								20,5	Altura Costilla 16
								29,5	Altura Costilla 22
								3	
<p>Puntos Total (52 + 56 + 56 + 69) + 55 = 288</p>							<p>Altura Total (3 + 15,5 + 20,5 + 20,5 + 29,5 + 3) = 92</p>		

ESTRUCTURA

Cajón frente cristal

Costillas laterales acabado único ANTRACITA

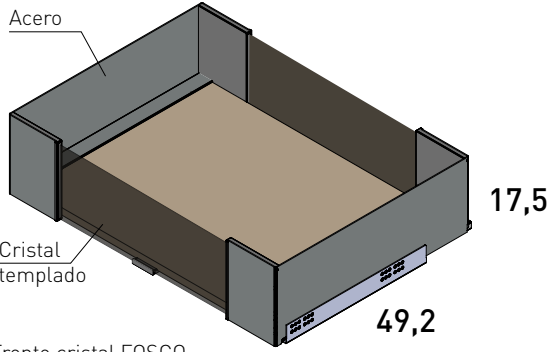

Frente cristal FOSCO

Acabados laminados base cajón

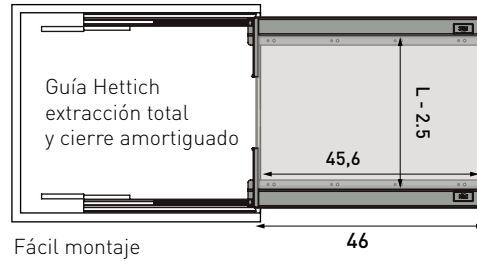
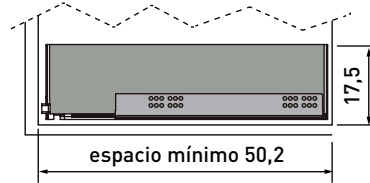

Fácil montaje

L hueco armario	Ref.	Puntos
36-46	CF146	159
46-56	CF156	165
56-66	CF166	168
66-76	CF176	179
76-86	CF186	186
86-96	CF196	192
96-106	CF106	199
106-116	CF116	206

Cajón frente cristal

Costillas laterales acabado único ANTRACITA

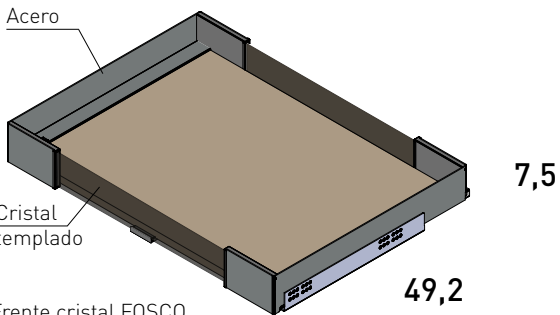

Frente cristal FOSCO

Acabados laminados base cajón

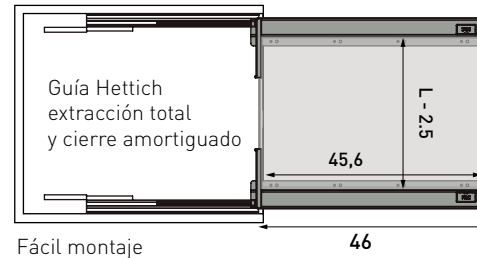
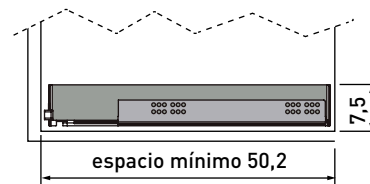

Fácil montaje

L hueco armario	Ref.	Puntos
36-46	CF746	146
46-56	CF756	150
56-66	CF766	154
66-76	CF776	161
76-86	CF786	167
86-96	CF796	174
96-106	CF706	181
106-116	CF716	189

COMPLEMENTOS

Joyero organizador

Acabado TITANIO

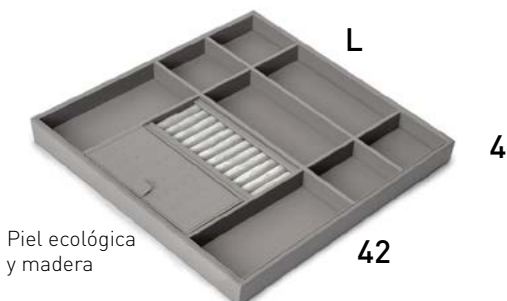

Piel ecológica y madera

L	Ref.	Puntos
44	JR4	88
54	JR5	100
64	JR6	112
74	JR7	124

Caja accesorios

Acabado único ANTRACITA
Acero

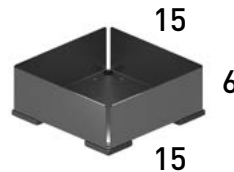

L	Ref.	Puntos
15	CAJ15	24

Bandeja accesorios

Acabado único ANTRACITA
Acero



L	Ref.	Puntos
28	BAN28	28
45	BAN45	30

ESTRUCTURA

Cajón zapatero frente cristal

Costillas laterales acabado único ANTRACITA

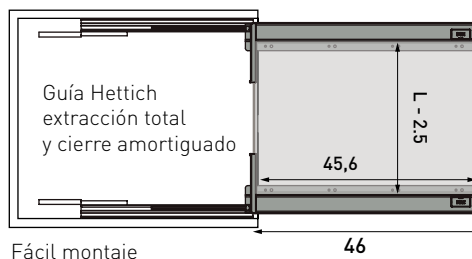
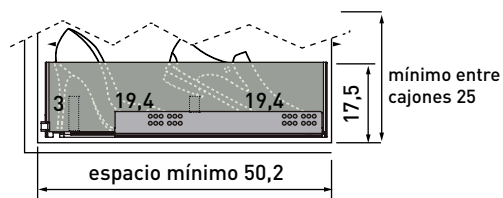
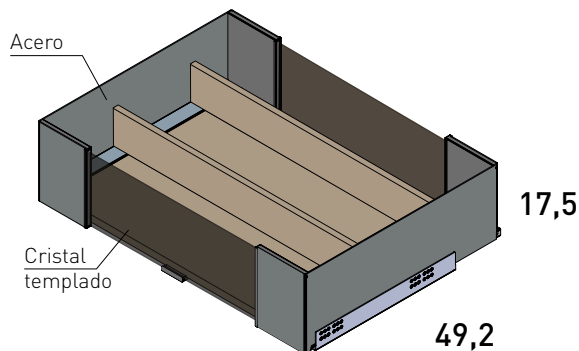

Acabados laminados base cajón



L hueco armario	Ref.	Puntos
36-46	CZ46	172
46-56	CZ56	179
56-66	CZ66	187
66-76	CZ76	198
76-86	CZ86	207
86-96	CZ96	214
96-106	CZ06	223
106-116	CZ16	230

COLGADORES

Perchero Abatible

Acabado único ANTRACITA

Acero

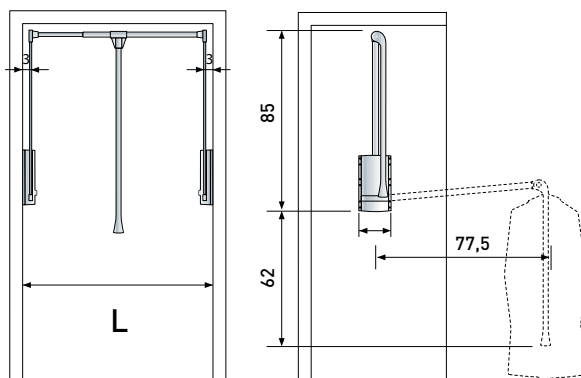
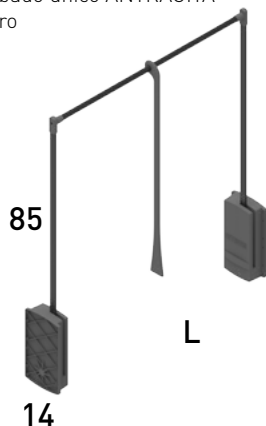

L hueco armario	Ref.	Puntos
44-60	PER4	114
60-90	PER6	130
90-116	PER7	134

Perchero extraíble SUPERIOR

Acabado único ANTRACITA

Acero

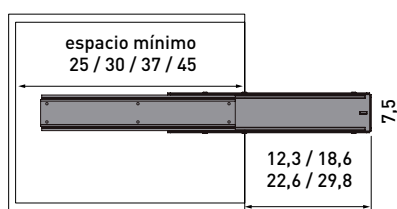

Carga máxima 15kg
Necesita estante superior

P	Ref.	Puntos
24	PEX24	44
29	PEX29	46
36	PEX36	48
44	PEX44	50

Barras colgar

Acabado ANTRACITA
Aluminio

Perfil superior minimiza ruido

Barra rectangular con 2 soportes de fijación a costado o estante

Necesita estante superior

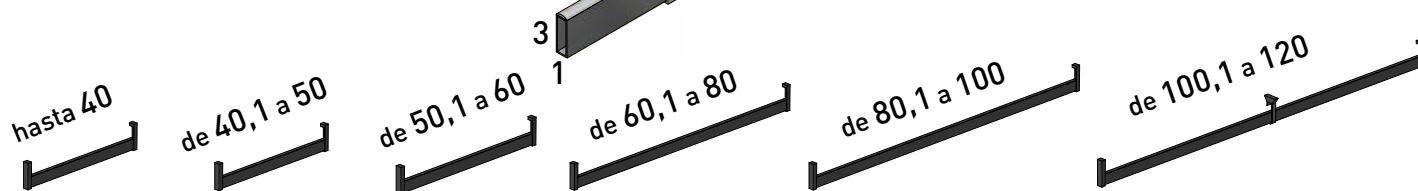

Incorpora 3 soportes.

Ref.	BL40	BL50	BL60	BL80	BL10	BL12
Puntos	18	21	25	27	30	38

ACCESORIOS

Zapatero lateral extraíble

Acabado único ANTRACITA
Acero

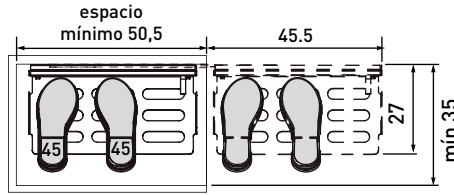
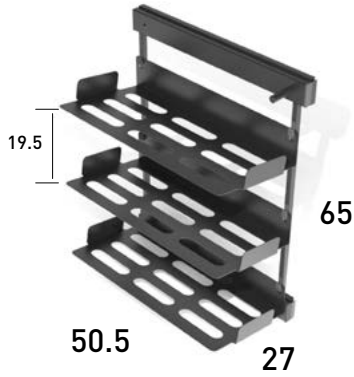

L	Ref.	Puntos
DR	Z65DS	184
IZ	Z65ZS	184

Cesta de tela

Estructura ANTRACITA
Acero / Tela gris

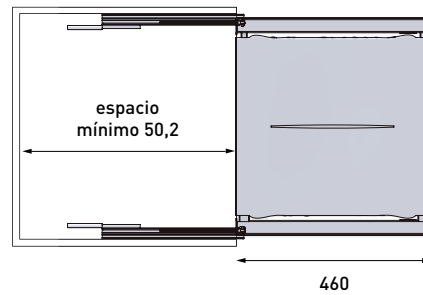

L	Ref.	Puntos
49,5-54,5	CET5S	214
54,5-59,5	CET6S	222

Corbatero lateral extraíble

Acabado único ANTRACITA
Acero

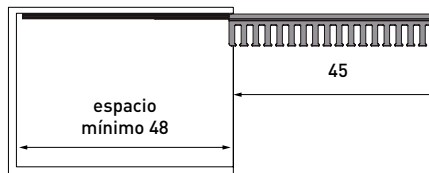
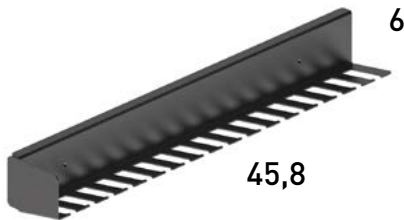

L	Ref.	Puntos
DR	COSD	53
IZ	COSZ	53

Espejo lateral extraíble

Acabado único GRAFITO

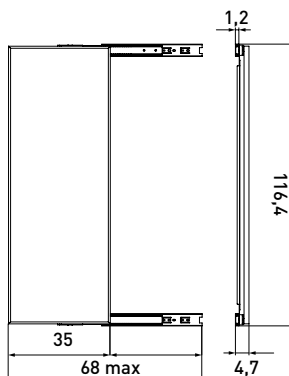
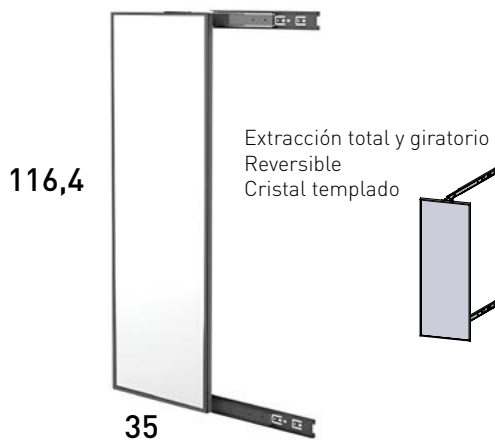

L	Ref.	Puntos
35	ESPES	78

PANTALONEROS

Guía Hettich extracción total y cierre amortiguado
Soportes con funda antideslizante

Bandeja pantalonero

Acabado único ANTRACITA
Acero

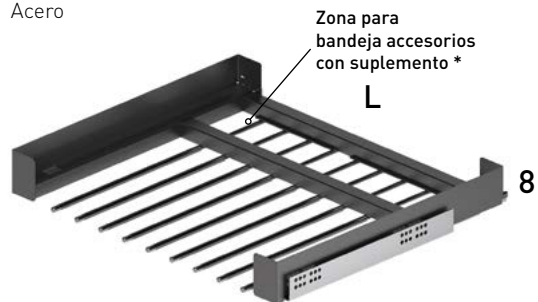

Carga máxima 30kg

49

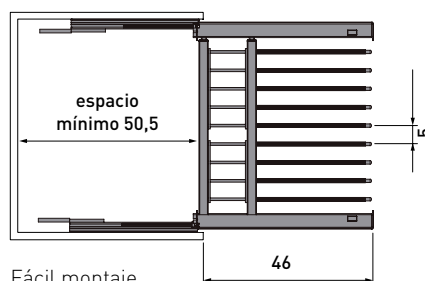

Fácil montaje

Soportes	L	Ref.	Puntos
7-9	46,5-56,5	PAX60S	192
9-11	56,5-66,5	PAX70S	198
11-13	66,5-76,5	PAX80S	207
13-15	76,5-86,5	PAX90S	215

Bandeja accesorios

Acabado único ANTRACITA



* Bandejas recomendadas según medida
de 46,5 a 61,5 cm 1 unidad
de 61,5 a 81,5 cm 2 unidades
de 81,5 a 86,5 cm 3 unidades

Ref.	Puntos
BDA24	14

Pantalonero extraíble LATERAL

Acabado único ANTRACITA
Acero

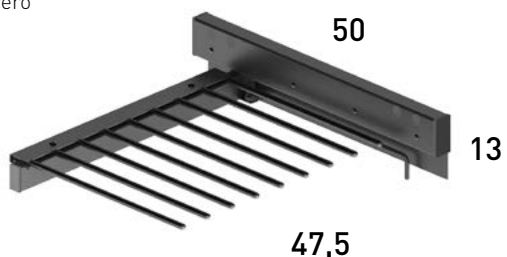

Reversible
Para 9 pantalones

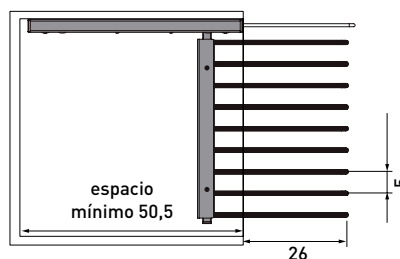

Ref.	Puntos
PAXS	121

Pantalonero extraíble SUPERIOR

Acabado único ANTRACITA
Acero

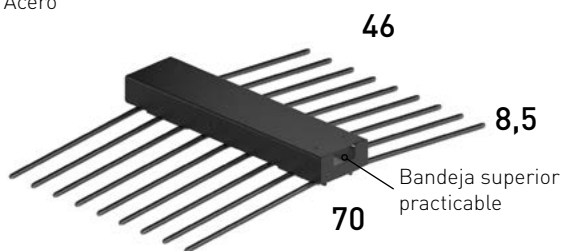

Para 18 pantalones.
Necesita estante superior

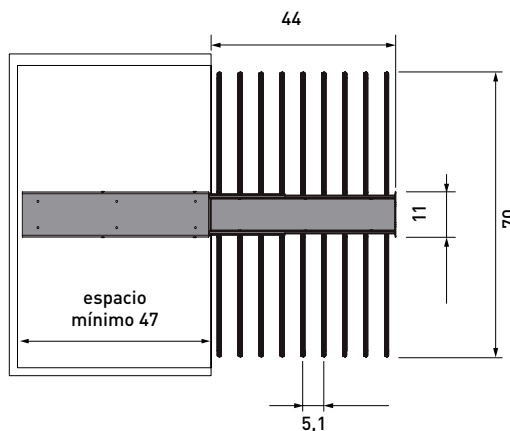

Ref.	Puntos
PAX18	148

Pantalonero extraíble SUPERIOR

Acabado único ANTRACITA
Acero

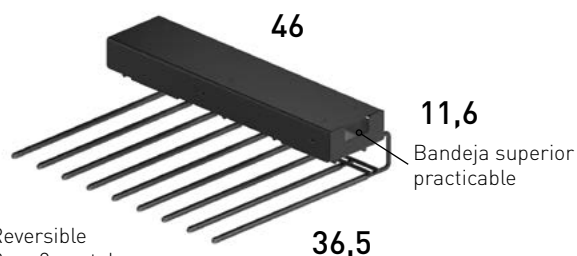

Reversible
Para 9 pantalones
Necesita estante superior

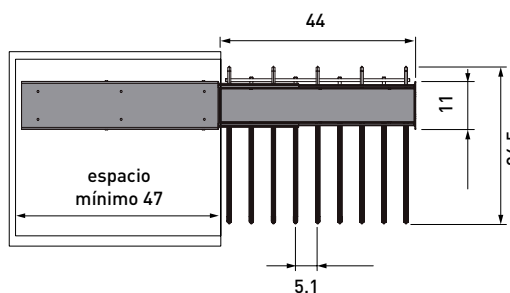

Ref.	Puntos
PAX9	112



Estructuras para interiores de armario
(Interiores no regulables en altura)



Columnas aluminio

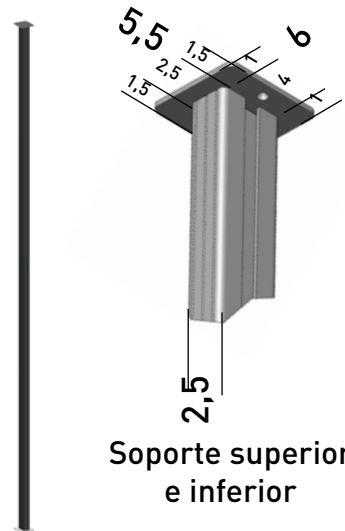

Altura	Ref.	Puntos
150 - 200	CAL1	86
201 - 274	CAL2	96

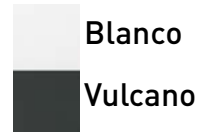

Estos estantes no tienen mano.



ESTANTES FONDO 55

Grueso 3

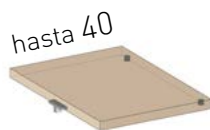

1 soporte incluido + 2 soportes UX

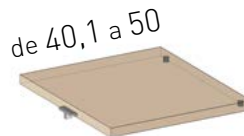

1 soporte incluido + 2 soportes UX

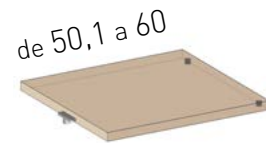

1 soporte incluido + 2 soportes UX

Ref.	ET94	ET95	ET96
Puntos	37	40	44

Grueso 3

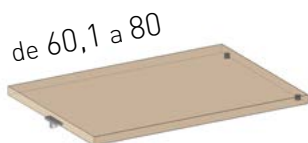

1 soporte incluido + 2 soportes UX

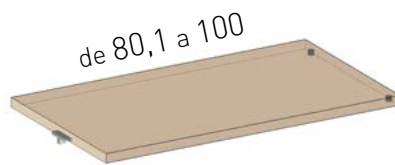

1 soporte incluido + 2 soportes UX

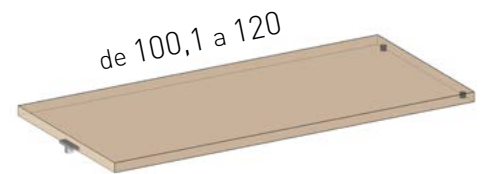

1 soporte incluido + 2 soportes UX

Ref.	ET98	ET90	ET92
Puntos	47	49	54



ESTANTES EXTRAIBLE FONDO 55

No tiene mano
Soportes incluidos

Grosor 3

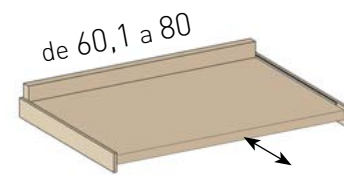
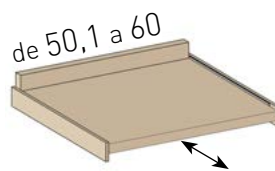
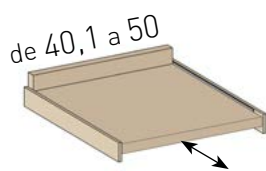

Ref.	ETX44	ETX54	ETX64	ETX84
Puntos	69	72	76	79

ESTANTES CRISTAL FONDO 55

No tiene mano
Soportes incluidos

Grosor 0.6

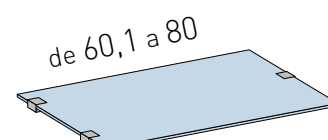
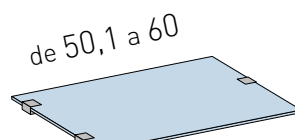
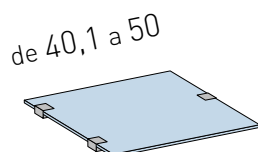
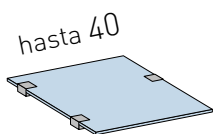

Ref.	EV44	EV54	EV64	EV84
Puntos	66	74	82	99

Grosor 0.6

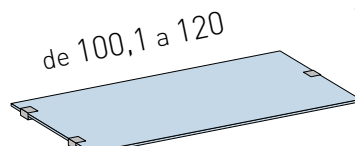
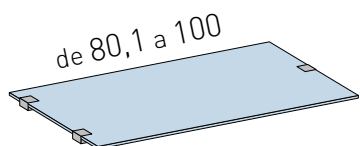

Acabados cristal
transparente y opaco

Acabados soporte
estante cristal



Ref.	EV104	EV124
Puntos	126	142

ZAPATERO FIJO FONDO 55

Soportes incluidos

Grosor 3

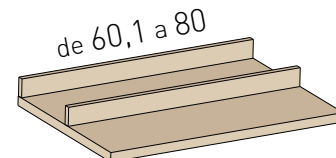
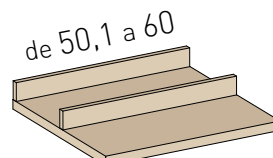
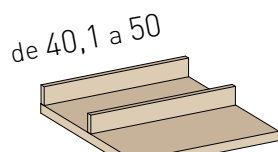
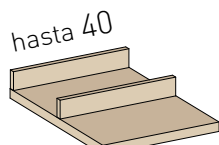

	izquierda	derecha	izquierda	derecha	izquierda	derecha	izquierda	derecha
Ref.	EZ44Z	EZ44D	EZ54Z	EZ54D	EZ64Z	EZ64D	EZ84Z	EZ84D
Puntos	49	49	53	53	57	57	62	62

Grosor 3

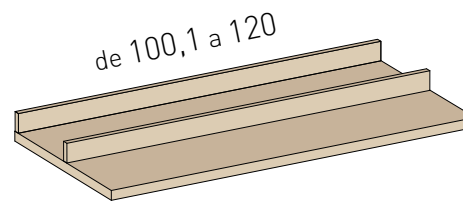
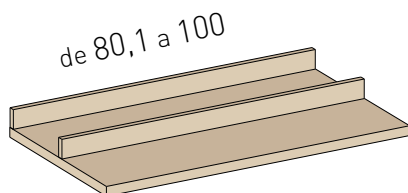

	izquierda	derecha	izquierda	derecha
Ref.	EZ104Z	EZ104D	EZ124Z	EZ124D
Puntos	65	65	71	71



ZAPATERO EXTRAÍBLE FONDO 55

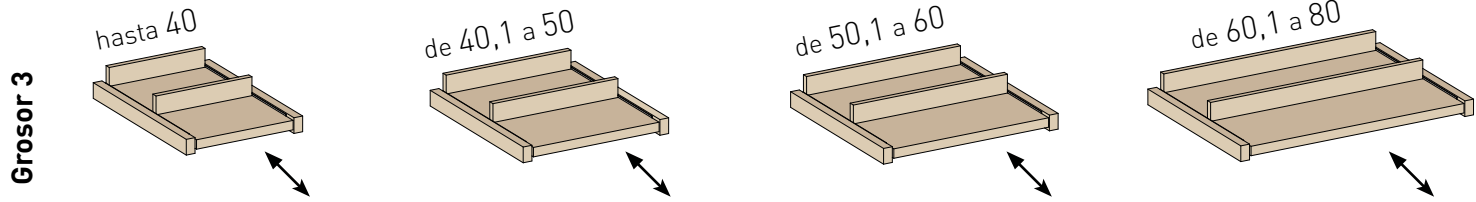

No tiene mano
Soportes incluidos

Ref.	EX44	EX54	EX64	EX84
Puntos	71	75	80	84

BARRAS



No tiene mano
Soportes incluidos

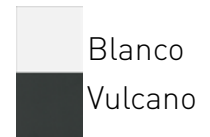

Cada barra incorpora un juego de dos soportes.

Ref.	BC45	BC56	BC68	BC100
Puntos	27	30	33	41

CAJONERAS FONDO 55



Costilla de 11
No tiene mano
Soportes incluidos

Ref.	CG163	CG183	CG103
Puntos	114	134	152



Ref.	CG263	CG283	CG203
Puntos	166	195	218

PANTALONEROS FONDO 55

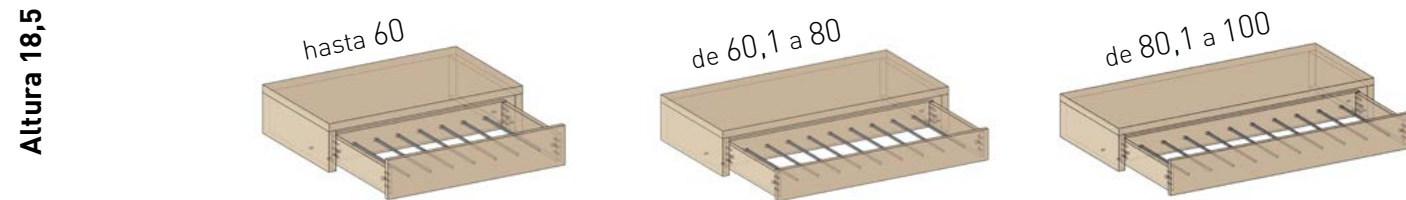

No tiene mano
Soportes incluidos

Ref.	PNT607	PNT687	PNT107
Puntos	162	182	198



COLUMNAS FONDO 58

Lado izquierdo

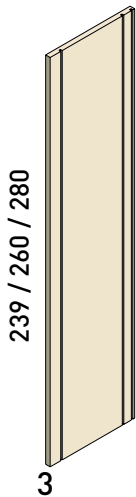

Altura	Ref.	Puntos
239	CLZ44R	140
260	CLZ46R	148
280	CLZ48R	152

Mecanizado lado derecho

Parte central

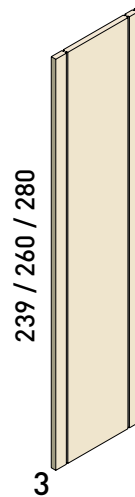

Altura	Ref.	Puntos
239	CLC44R	199
260	CLC46R	208
280	CLC48R	212

Mecanizado dos lados

Lado derecho



Altura	Ref.	Puntos
239	CLD44R	140
260	CLD46R	148
280	CLD48R	152

Mecanizado lado izquierdo

BUCS FONDO 58

Buc superior e inferior con ranura

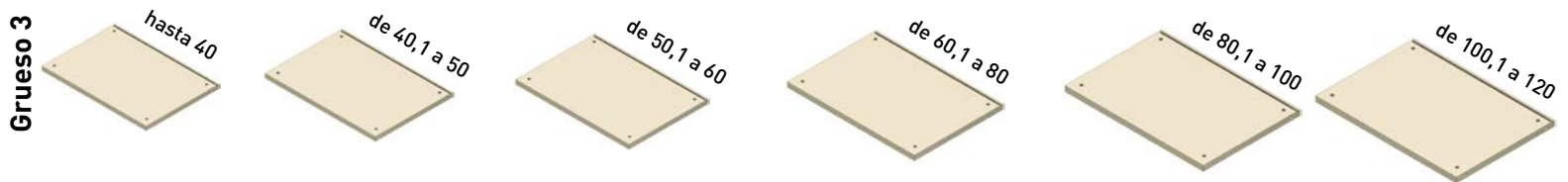

Ref.	BU44R	BU45R	BU46R	BU48R	BU410R	BU412R
Puntos	23	26	30	33	35	40

TRASERAS

Grosor 1

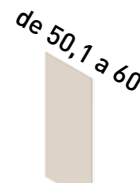
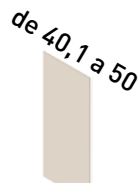
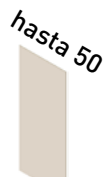

Ref.	BASE		STONE		BASE		STONE		BASE		STONE	
	TSR14	TSS14	TSR15	TSS15	TSR16	TSS16						
Puntos	31	34	39	43	47	52						

Grosor 1

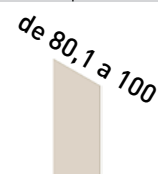
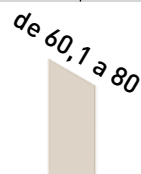

Ref.	BASE		STONE		BASE		STONE	
	TSR18	TSS18	TSR10	TSS10	TSR12	TSS12		
Puntos	62	68	78	86	93	102		

MOLDURA RINCÓN

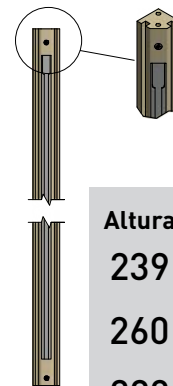

Altura	Ref.	Puntos
239	ML239R	69
260	ML260R	79
280	ML280R	84

BUC / ESTANTE RINCÓN

Grosor 3

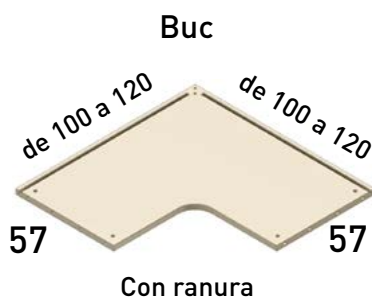

Con ranura

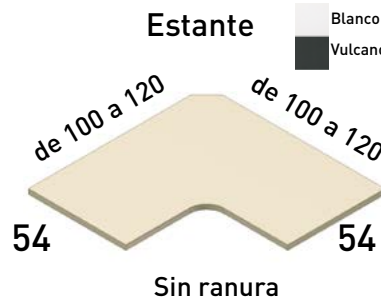

Sin ranura

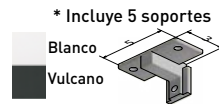

* Incluye 5 soportes

Blanco
Vulcano

* Obligatorio un estante superior

Barra rectangular con 4 soportes de fijación a costado o estante.

Perfil superior minimiza ruido

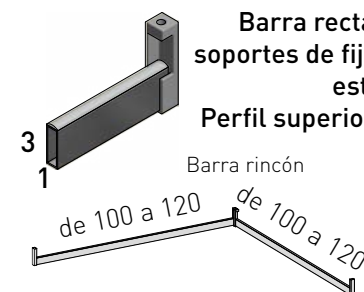

Barra rincón

Blanco
Vulcano

Ref.	BUR8R	ER54R	BNR
Puntos	96	116	53

ESTANTES FONDO 55

* Incluye 4 soportes

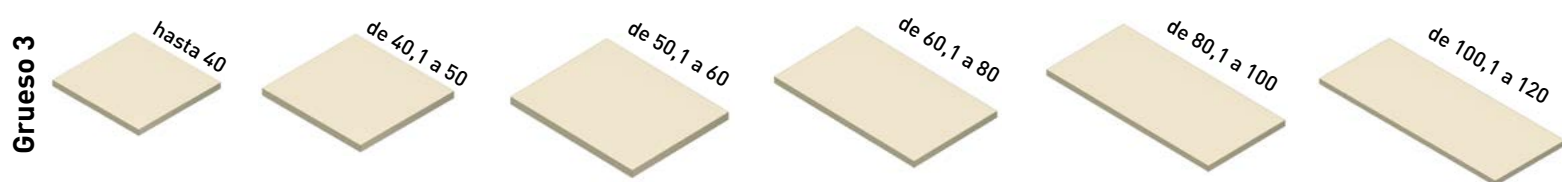
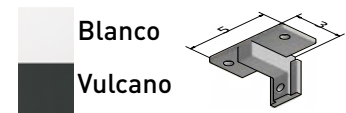

Ref.	ET84R	ET85R	ET86R	ET88R	ET80R	ET82R
Puntos	36	39	43	46	48	53

ESTANTES EXTRAIBLES FONDO 55

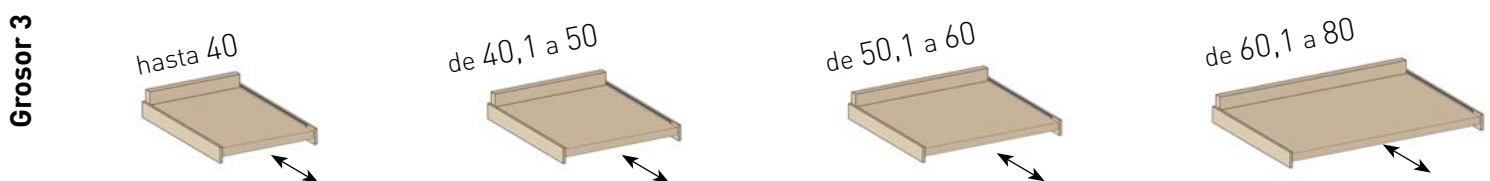

Ref.	ETT84R	ETT85R	ETT86R	ETT88R
Puntos	68	71	75	79

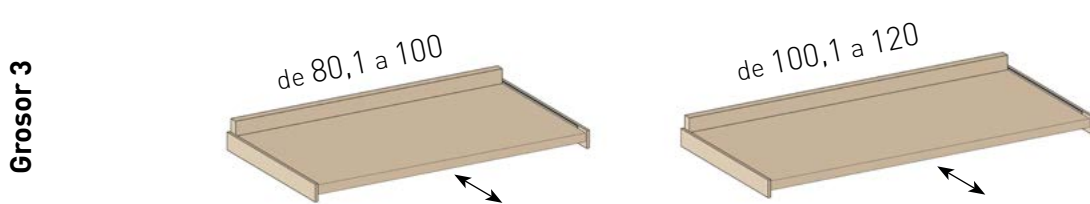

* Incluye 4 soportes



Ref.	ETT80R	ETT82R
Puntos	80	85

ESTANTES CRISTAL FONDO 55

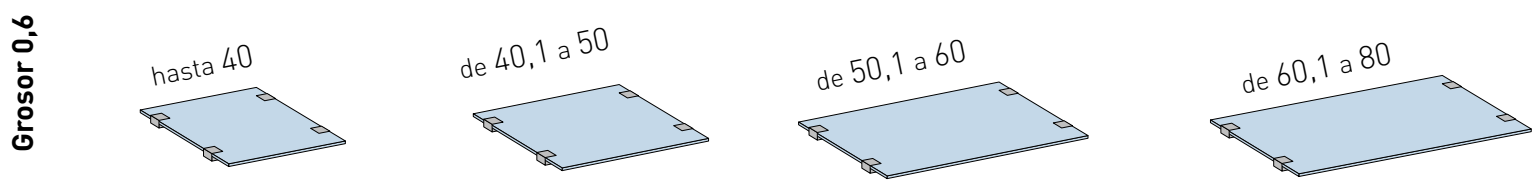

Ref.	EV43R	EV53R	EV63R	EV83R
Puntos	76	84	92	108

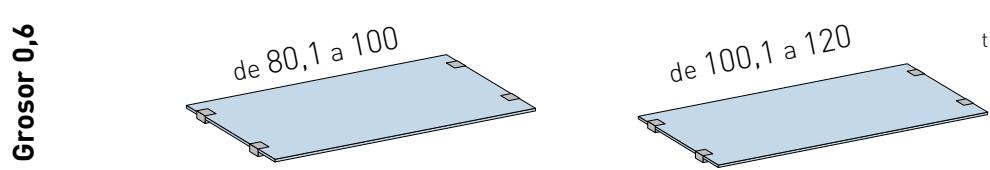

Acabados cristal transparente y opaco

Acabados soporte estante cristal



Ref.	EV103R	EV123R
Puntos	126	152

BARRAS

* Obligatorio un estante superior

Blanco
Vulcano

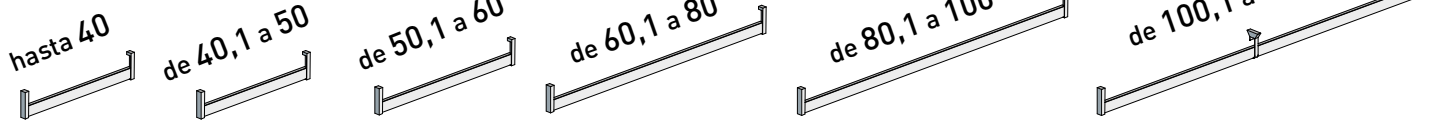

Barra rectangular con 2 soportes de fijación a estante. Perfil superior minimiza ruido

Incorpora 3 soportes.

Ref.	BC4R	BC5R	BC6R	BC8R	BC10R	BC12R
Puntos	18	21	24	27	30	37

ZAPATERO FIJO FONDO 55

Grosor 3

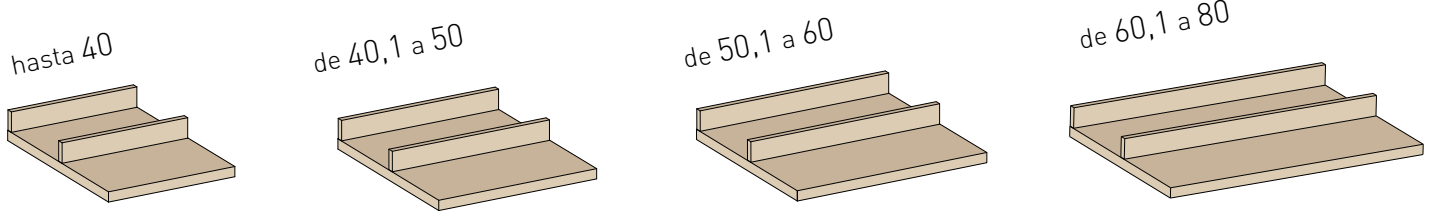

Ref.	EZ43R	EZ53R	EZ63R	EZ83R
Puntos	48	52	57	61

Grosor 3

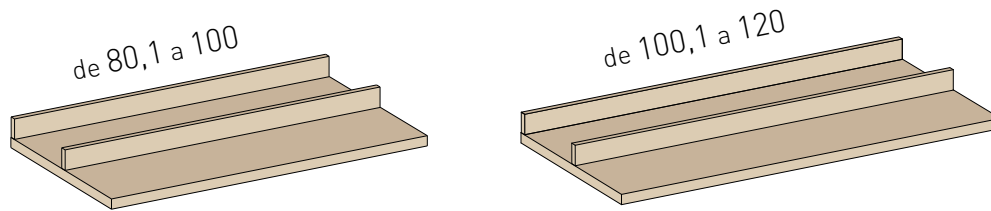

* Incluye 4 soportes

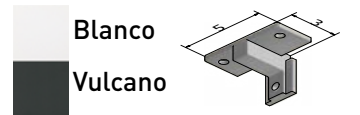

Ref.	EZ103R	EZ123R
Puntos	64	70

ZAPATERO EXTRAÍBLE FONDO 55

Grosor 3

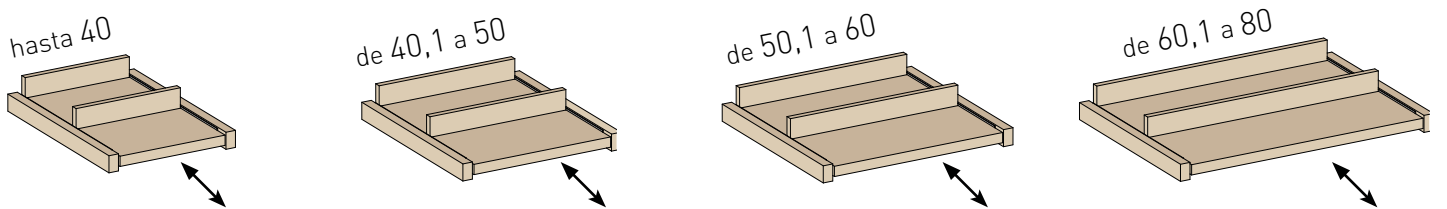

Ref.	EX43R	EX53R	EX63R	EX83R
Puntos	73	77	82	86

Grosor 3

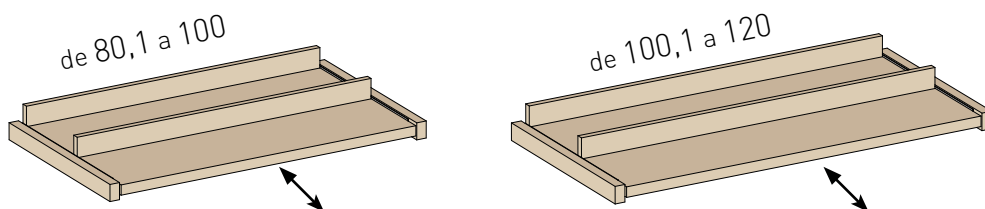

* Incluye 4 soportes

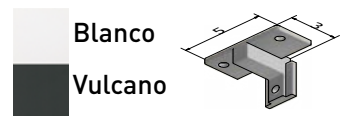

Ref.	EX103R	EX123R
Puntos	89	95

PARTIDORES FONDO 55

*Por defecto incluye Rail System por ambos lados.

Grosor 3

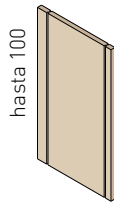

hasta 100



de 100,1 a 150

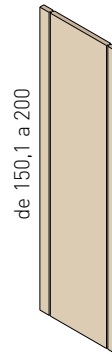

de 150,1 a 200



desde 200,1

Ref.	DNT103R	DNT153R	DNT203R	DNT303R
Puntos	94	124	163	174

PARTIDORES ALUMINIO

Grosor 3

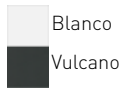

* Compatible solo con cajoneras colgadas

hasta 100



de 100,1 a 150



de 150,1 a 200



desde 200,1

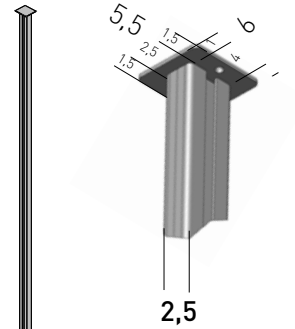

Soporte superior e inferior

Ref.	CAL10	CAL15	CAL20	CAL30
Puntos	46	52	86	96

OPCIONES

Zapatero extensible y extraíble

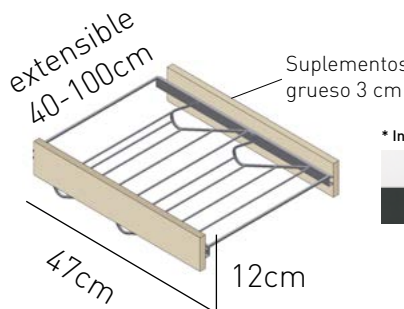

Suplementos grueso 3 cm

* Incluye 4 soportes

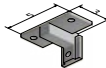
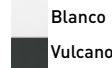

Barra abatible y extensible

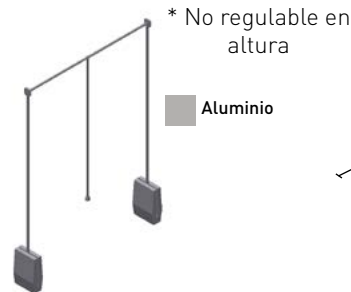

Aluminio

60cm mín / 115cm máx

Mesa planchar plegable

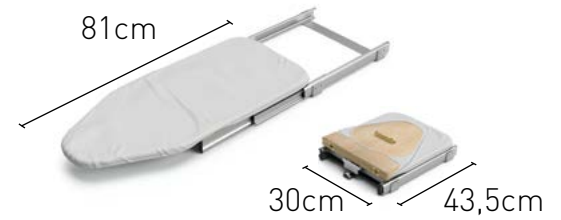

Precisa de un estante de soporte.

Ref.	ZPR3	BRT	TPL
Puntos	105	110	168

LEDS

*Sensor movimiento incorporado

1 tira de led



2 tiras de leds



Ref.	LED10	LED20
Puntos	168	288

CAJONERAS FONDO 55

Altura 21,5

hasta 40



de 40,1 a 60



de 60,1 a 80



de 80,1 a 100



de 100,1 a 120



* Incluye 4 soportes

Blanco

Vulcano

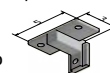

Ref.	CG1314R	CG1316R	CG1318R	CG1310R	CG1312R
Puntos	115	131	151	168	228

Altura 37

hasta 40



de 40,1 a 60



de 60,1 a 80



de 80,1 a 100



de 100,1 a 120



Ref.	CG2314R	CG2316R	CG2318R	CG2310R	CG2312R
Puntos	165	183	211	234	332

Altura 52,5

hasta 40



de 40,1 a 60



de 60,1 a 80



de 80,1 a 100



Ref.	CG3314R	CG3316R	CG3318R	CG3310R
Puntos	215	235	271	300

Altura 68

hasta 40



de 40,1 a 60



de 60,1 a 80



de 80,1 a 100



Ref.	CG4314R	CG4316R	CG4318R	CG4310R
Puntos	265	287	331	366

PANTALONEROS FONDO 55

Altura 18,5

hasta 60



de 60,1 a 80

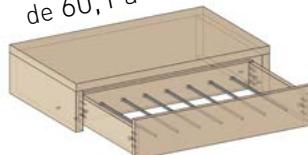

de 80,1 a 100



* Incluye 4 soportes

Blanco

Vulcano

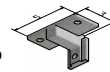

Ref.	PNT606R	PNT686R	PNT106R
Puntos	174	188	204

CAJONERAS FONDO 55

Altura 26,5

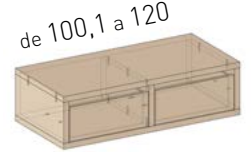

* Incluye 4 soportes



Ref.	CGN1364R	CG1366R	CG1368R	CG1360R	CG1362R
Puntos	120	135	155	172	236

Altura 47

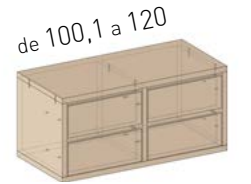

Ref.	CG2364R	CG2366R	CG2368R	CG2360R	CG2362R
Puntos	170	191	219	242	348

Altura 67,5



Ref.	CG3364R	CG3366R	CG3368R	CG3360R
Puntos	225	247	283	312

Incremento por separadores (Cajón no incluido)

SEPARADORES CAJONES

Altura 18,5

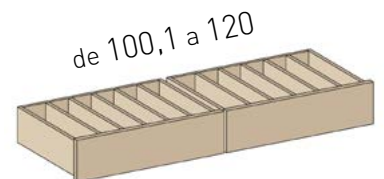
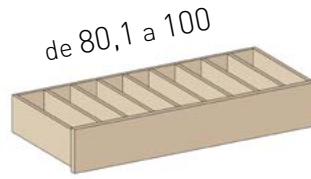
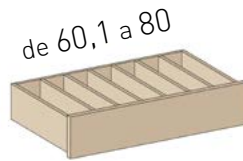
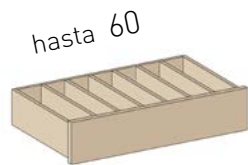

Ref.	CRB665R	CRB685R	CRB105R	CRB125R
Puntos	24	30	34	42

CASILLERO FONDO 55

Altura 36

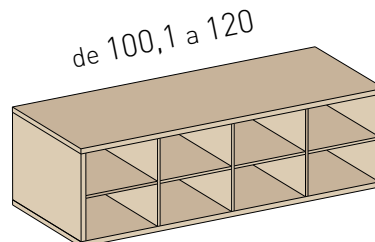
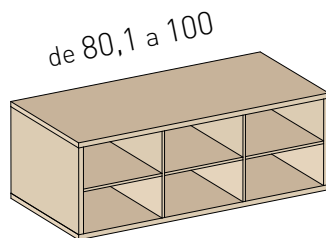
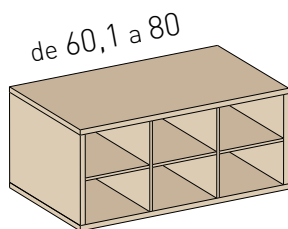

* Incluye 4 soportes



Ref.	CS82R	CS102R	CS122R
Puntos	120	144	170

Disponibles cajones de 11 y 16 cm de alto en costilla.

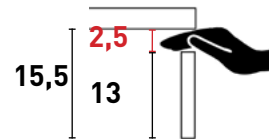

Ancho total de 40 a 60		Ancho total de 60,1 a 80		Ancho total de 80,1 a 100	
Altura Costilla	Altura Total	Altura Costilla	Altura Total	Altura Costilla	Altura Total
11	15,5	11	15,5	11	15,5
16	20,5	16	20,5	16	20,5
Ref.	Puntos	Ref.	Puntos	Ref.	Puntos
CGN316R	52	CGN318R	60	CGN310R	66
CGN366R	56	CGN368R	64	CGN360R	70

El precio de los lados de la cajonera va incluido en cada cajon.

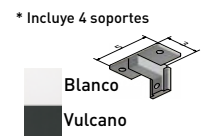

Ancho total de 40 a 60	Ancho total de 60,1 a 80	Ancho total de 80,1 a 100			
Ref.	Puntos	Ref.	Puntos	Ref.	Puntos
CFN346R	79	CFN368R	92	CFN380R	102
Tapa y base	Tapa y base	Tapa y base	Tapa y base	Tapa y base	Tapa y base

Seleccionar altura y cantidad de cajones + una tapa (obligatoria), todos del mismo ancho. Con estas referencias ya podemos crear la cajonera de libre composición.

Ejemplo de cajonera de 40 a 60:

11	CGN316R	52	+	CFN346R	79	=		Altura frente + espacio entre cajones	3	Altura Tapa
16	CGN366R	56						15,5	Altura Costilla 11	
16	CGN366R	56						20,5	Altura Costilla 16	
16	CGN366R	56					20,5	Altura Costilla 16		
							3	Altura Tapa		
<p>Puntos Total (52 + 56 + 56) + 79 = 243</p>								<p>Altura Total (3 + 15,5 + 20,5 + 20,5 + 3) = 62,5</p>		

COLUMNAS

28

5,5

6

Blanco

Vulcano

Tapeta rincón

Altura	Ref.	Puntos
239	CA240	111
260	CA260	120
280	CA280	127

Altura	Ref.	Puntos
239	TR240R	65
260	TR260R	69
280	TR280R	73

ESTANTES FONDO 55

Grueso 3

hasta 40

de 40,1 a 50

de 50,1 a 80

2 soportes incluidos

2 soportes incluidos

2 soportes incluidos

Ref.	ET44	ET45	ET48
Puntos	56	58	66

Grueso 3

de 80,1 a 100

de 100,1 a 120

2 soportes incluidos

2 soportes incluidos

Ref.	ET410	ET415
Puntos	71	83

ESTANTE RINCÓN

Grueso 3

de 100 a 120

de 100 a 120

55

55

3

2 soportes incluidos

Ref.	ER55C
Puntos	95

CAJONERAS FONDO 55

Costilla de 11

Soportes incluidos

Altura 21,5



Ref.	CG162	CG182	CG102
Puntos	125	145	162

Altura 37



Ref.	CG262	CG282	CG202
Puntos	177	205	228

Para cajón separador pag 282

PANTALONEROS FONDO 55

Soportes incluidos

Altura 18,5

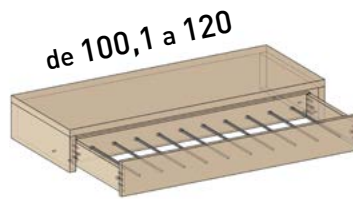
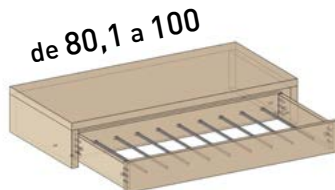
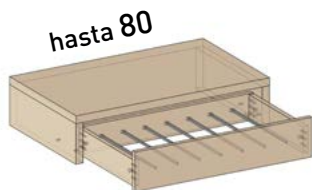

Ref.	PNT608	PNT688	PNT108
Puntos	156	172	184

BARRAS

* Obligatorio un estante superior

- Blanco
- Vulcano

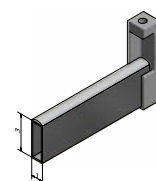
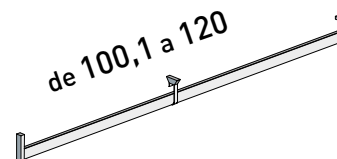
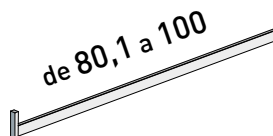
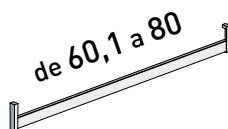
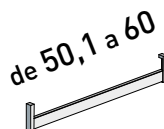

Barra rectangular con 2 soportes de fijación a estante. Perfil superior minimiza ruido

Incorpora 3 soportes.

Ref.	BCM4	BCM5	BCM6	BCM8	BCM10	BCM12
Puntos	35	38	39	42	46	50

jotajotape

ARMARIOS MODULARES APILAR



ESPECIALES ARMARIOS MODULARES

ESPECIALES GENERALES

MODIFICACIÓN DIMENSIONES (Norma general se aplica si no existe norma específica)

AUMENTAR SÓLO CUANDO NO EXISTA REFERENCIA SUPERIOR

RECORTAR

**PUNTOS BASE REFERENCIA
DE MEDIDA SUPERIOR** +15%

POR REDUCIR VARIAS DIMENSIONES A LA VEZ
SE APLICARÁ UN SOLO INCREMENTO DEL 15%

AUMENTAR DIMENSIONES HASTA UN 10%

**PUNTOS BASE REFERENCIA
DE MEDIDA MÁXIMA** +25%

POR AUMENTAR VARIAS DIMENSIONES A LA VEZ
SE APLICARÁ UN SOLO INCREMENTO DEL 25%

ESPECIALES ESPECÍFICOS

TODOS LOS MODELOS DE MÓDULOS

Aumentar fondo, exclusivamente, a 70cm	+10%
Aumentar fondo, exclusivamente, a 80cm	+15%
Cajeado de módulo	95 puntos por cajeo
Sustituir 2 cajones de 18cm por un cajón contenedor	+15 puntos
Ranuras para colocación de led (puntos mínimos 20)	+20 p/ml
Cremallera (puntos mínimos 15)	+15 p/ml
Por cada estante interior de 3 cm	+5 puntos

GUÍAS PUSH EXTRACCIÓN TOTAL (OPCIONAL)

Disponible en los módulos de cajones definidos en las páginas 292, 296 * Incremento **+6** puntos

* Imprescindible forro perimetral (tapas y costados), ya que debido al sistema de expulsión el fondo total del módulo se incrementa 4 mm. Ejemplo: Para módulos de 45 y 60cm de fondo, tapas y forros de 45.6cm y 60.6 respectivamente.

Importante para composiciones que utilicen otros elementos sin guía PUSH ya que mantendrán su medida original de fondo.

VER PÁGINA 303 PARA OTRA GUÍAS

**CONSULTAR CON FÁBRICA ESPECIALES NO DEFINIDOS
PARA SU VALORACIÓN Y VIABILIDAD TÉCNICA**

CONJUNTOS MODULARES PARA APILAR



Estructura

Puertas / Frente cajones

Estante

- Interior cajón en arena.



- Profundidad de 45 y 60cm para adaptarse a las literas abatibles y armarios.
- Misma holgura de frentes a suelo que camas abatibles. Para ajustar frentes con armarios consultar fábrica.
- Módulos bajos de 54, 72 y 90cm de altura y módulos altos de 72, 90, 108, 126cm de altura. Para otras medidas consultar con fábrica.
- Disponibles con cajones, puertas y diáfanos.
- Se puede añadir forro a costados.



- Bisagras con cierre amortiguado.
- Todos los cajones de 18cm de altura.
- Cajones con guías ocultas de **extracción total** y autocierre amortiguado.
- Guía oculta.
- El color de cada cajón se define individualmente.
- El modelo y color de cada tirador se define individualmente.



- Módulos bajos incorporan tacos de 1cm.
- 1cm extra se deben tener en cuenta para la altura total (no están contabilizados en las medidas de tarifa).

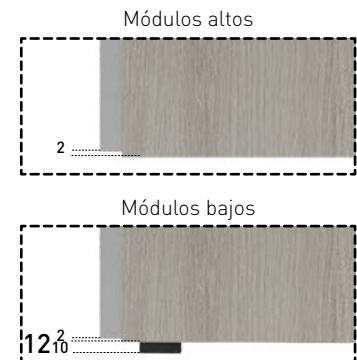

MÓDULO DIÁFANO FUELLE



Estructura



- Módulo grosor de 1,9cm como accesorio decorativo para diferentes usos.
- Profundidades de 43 y 58cm adaptándose a los nuevos módulos de apilar.
- Elemento no estructural, necesario fijar elementos que acompañan a la estructura
- Posibilidad de añadir LED.



EJEMPLOS CONJUNTOS MODULARES PARA APILAR

unidades	referencia	puntos
1	MAJ50	434 434
1	CNF60	136 136
1	MAH60P	322 322
2	FR6225	76 152
		total puntos 1044

unidades	referencia	puntos
1	MAB60P	237 237
1	CNF60	136 136
1	MAH60P	322 322
		total puntos 695

unidades	referencia	puntos
1	MAB40P	187 187
1	CNS30	104 104
1	PRB39	23 23
1	MAT70P	262 262
		total puntos 576

unidades	referencia	puntos
1	DF60	257 257
1	ARB44Z	176 176
1	ARB44D	176 176
1	PJA4D	68 68
1	PJA4Z	68 68
1	MAJ35Z	141 141
1	MAJ35D	141 141
1	MAJ35	223 223
1	MAH45D	151 151
1	MAH40P	222 222
		total puntos 1623

MÓDULOS BAJOS

Estructura y estantes de 1,9



50/80/100

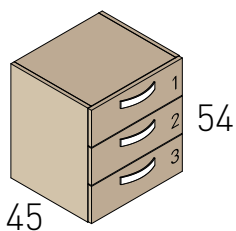

largo	referencia	puntos
50	MAB35	203
80	MAB38	246
100	MAB30	282

50/80/100

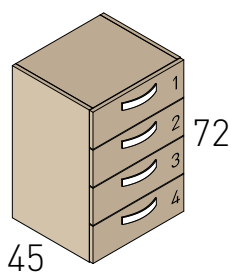

largo	referencia	puntos
50	MAB45	249
80	MAB48	303
100	MAB40	351

50/80/100



largo	referencia	puntos
50	MAB55	294
80	MAB58	359
100	MAB50	407

50/80/100

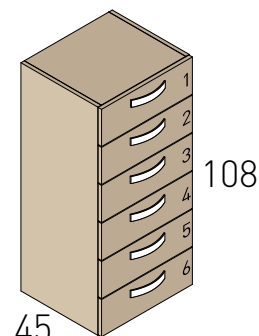

largo	referencia	puntos
50	MAB65	339
80	MAB68	385
100	MAB60	426

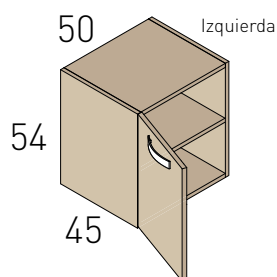

largo	referencia	puntos
50	MAB35Z	127

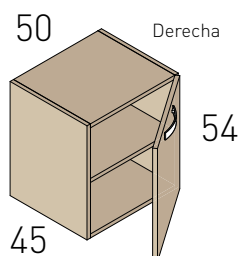

largo	referencia	puntos
50	MAB35D	127

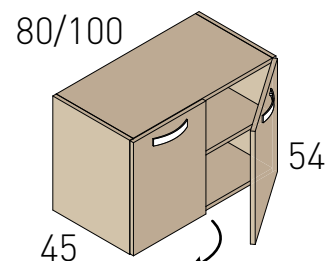

largo	referencia	puntos
80	MAB38P	153
100	MAB30P	167

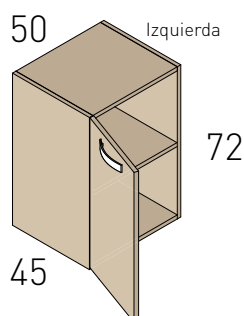

largo	referencia	puntos
50	MAB45Z	135

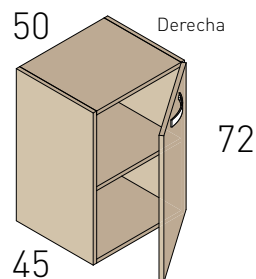

largo	referencia	puntos
50	MAB45D	135

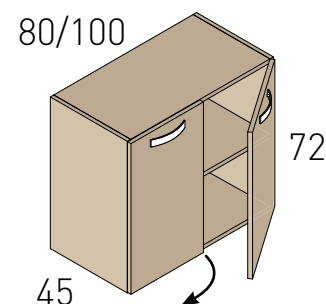

largo	referencia	puntos
80	MAB48P	176
100	MAB40P	187

* PARA REBAJE ZÓCALO INCREMENTAR 12 PUNTOS
max. 1cm de fondo

Para frentes acabado Stone añadir 8 puntos/m², con un mínimo de 2 puntos por pieza
Incremento de 5 puntos por cada estante grueso 3cm

* IMPRESCINDIBLE INDICAR MEDIDA DE ZÓCALO

MÓDULOS BAJOS

Estructura y estantes de 1,9

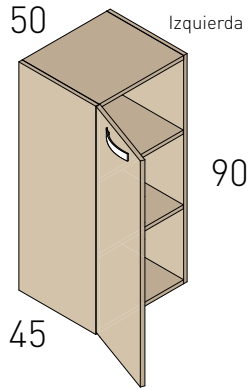

largo	referencia	puntos
50	MAB55Z	153

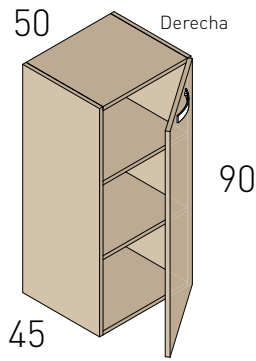

largo	referencia	puntos
50	MAB55D	153

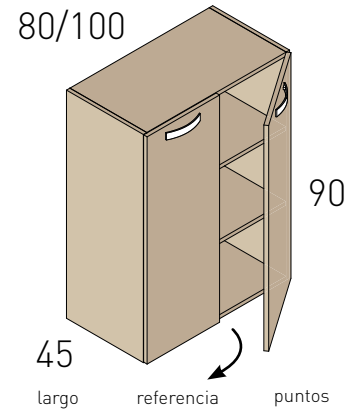

largo	referencia	puntos
80	MAB58P	193
100	MAB50P	217

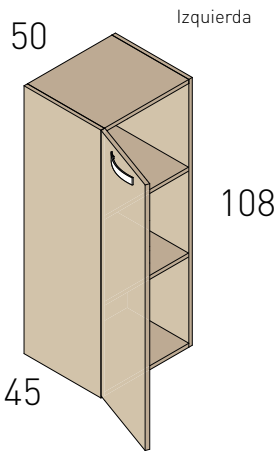

largo	referencia	puntos
50	MAB65Z	161

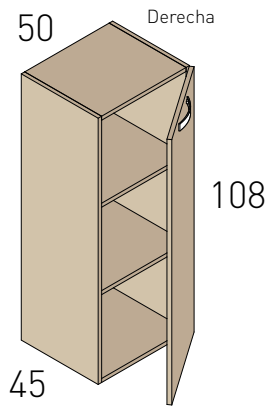

largo	referencia	puntos
50	MAB65D	161

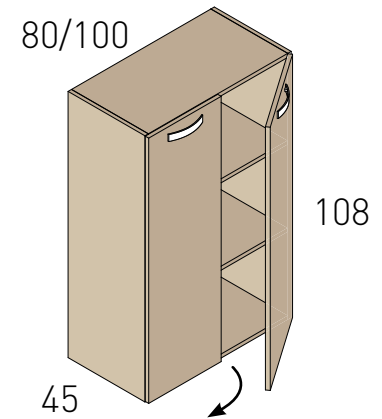

largo	referencia	puntos
80	MAB68P	209
100	MAB60P	237

* PARA REBAJE ZÓCALO INCREMENTAR 12 PUNTOS
max. 1cm de fondo

MÓDULOS A HUECO

CUBO INSIDE

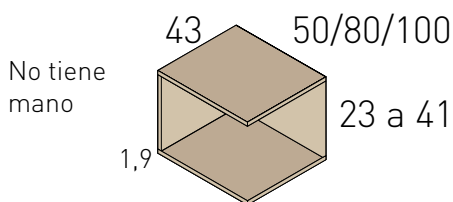

largo	referencia	puntos
50	CNS35	66
80	CNS38	92
100	CNS30	104

Necesario añadir partidor RIB a partir de 50

CUBO FUELLE

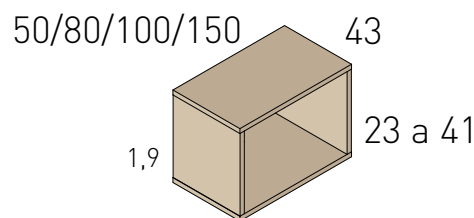

largo	referencia	puntos
50	CNF45	76
80	CNF48	104
100	CNF40	118
150	CNF41	152

Necesario añadir partidor RIB a partir de 100

PARTIDOR FUELLE RIB

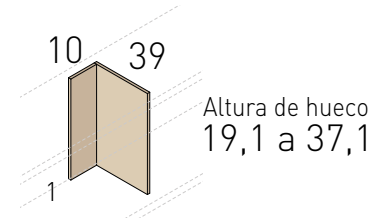

fondo	referencia	puntos
39	PRB39	23

Indicar medida altura

Para frentes acabado Stone añadir 8 puntos/m2, con un mínimo de 2 puntos por pieza

* IMPRESCINDIBLE INDICAR MEDIDA DE ZÓCALO

MÓDULOS ALTOS

Estructura y estantes de 1,9

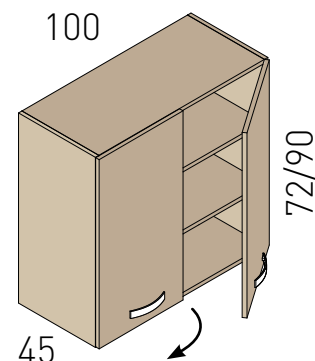
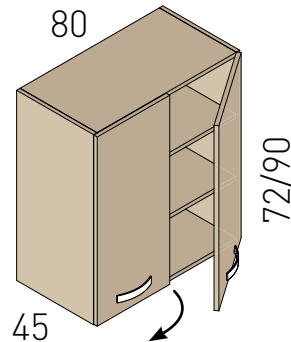
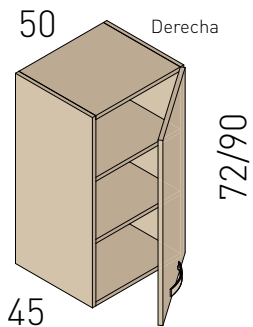
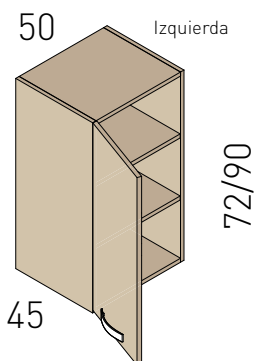

altura	referencia	puntos
72	MAT45Z	135
90	MAT55Z	153

altura	referencia	puntos
72	MAT45D	135
90	MAT55D	153

altura	referencia	puntos
72	MAT48P	176
90	MAT58P	193

altura	referencia	puntos
72	MAT40P	187
90	MAT50P	217

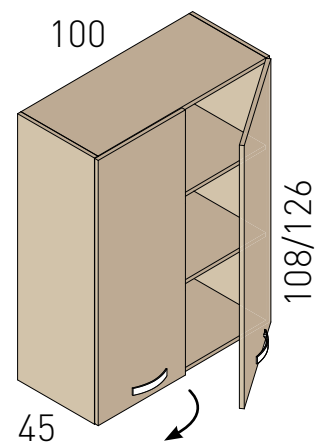
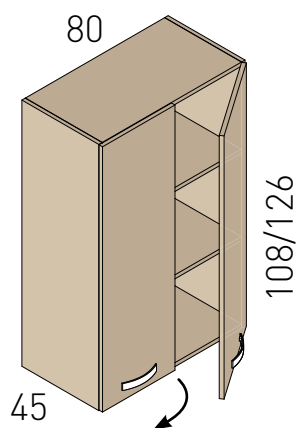
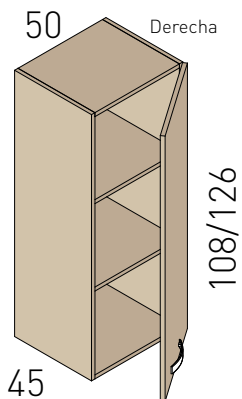
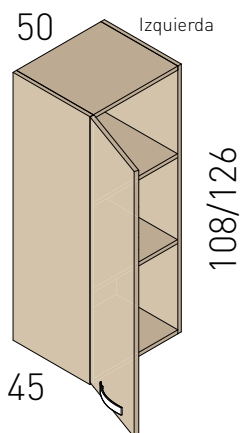

altura	referencia	puntos
108	MAT65Z	166
126	MAT75Z	169

altura	referencia	puntos
108	MAT65D	166
126	MAT75D	169

altura	referencia	puntos
108	MAT68P	214
126	MAT78P	230

altura	referencia	puntos
108	MAT60P	242
126	MAT70P	262

Para frentes acabado Stone añadir 8 puntos/m², con un mínimo de 2 puntos por pieza
Incremento de 5 puntos por cada estante grueso 3cm

FORRO LATERAL

ESTANTE INTERIOR

Grueso 1cm

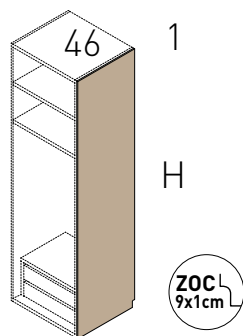

Grueso 1,9cm

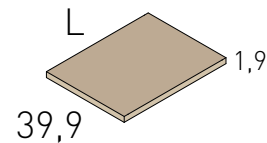
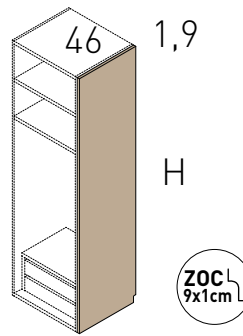

H	Acabados BASE		Acabados STONE	
	referencia	puntos	referencia	puntos
100	FR4110	23	FS4110	26
150	FR4115	36	FS4115	40
200	FR4120	46	FS4120	50
250	FR4125	57	FS4125	62
282	FR4128	65	FS4128	71

H	Acabados BASE		Acabados STONE	
	referencia	puntos	referencia	puntos
100	FR4210	29	FS4210	32
150	FR4215	44	FS4215	49
200	FR4220	58	FS4220	62
250	FR4225	75	FS4225	82
282	FR4228	82	FS4228	89

L	referencia	puntos
46,1	E246	26
76,1	E276	29
96,1	E296	32

Incremento 5 puntos por cada estante grueso 3cm

Forro con rebaje zócalo por defecto de 9x1cm

MÓDULO DIÁFANO FUELLE

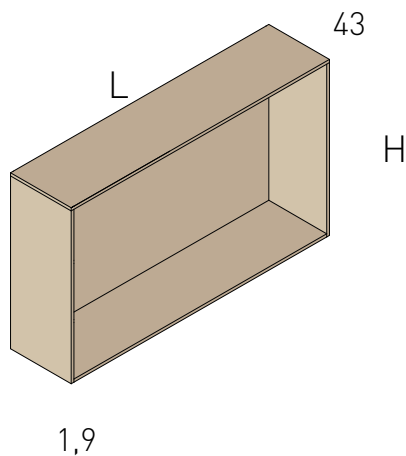

fondo	referencia	puntos/M2
43	DF45	132

puntos por m2 + puntos mínimo 100

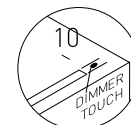
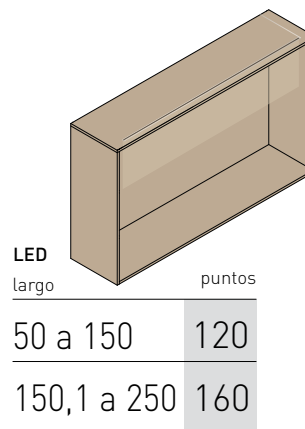

Indicar posición de interruptor izquierda o derecha

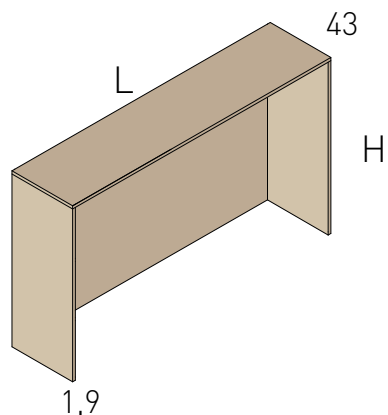

fondo	referencia	puntos/M2
43	DFB45	127

puntos por m2 + puntos mínimo 100

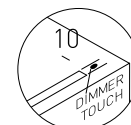
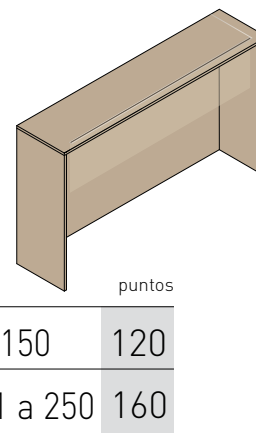

Indicar posición de interruptor izquierda o derecha



MÓDULOS BAJOS

Estructura y estantes de 1,9



50/80/100

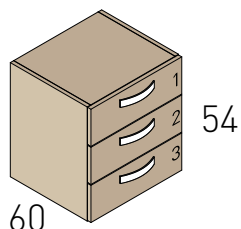

largo	referencia	puntos
50	MAJ35	223
80	MAJ38	268
100	MAJ30	306

50/80/100

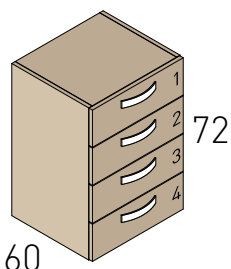

largo	referencia	puntos
50	MAJ45	271
80	MAJ48	327
100	MAJ40	377

50/80/100



largo	referencia	puntos
50	MAJ55	318
80	MAJ58	359
100	MAJ50	434

50/80/100

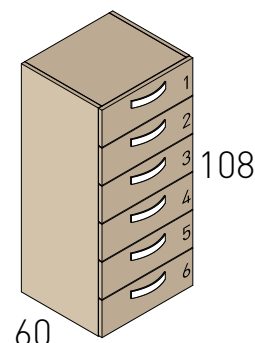

largo	referencia	puntos
50	MAJ65	365
80	MAJ68	413
100	MAJ60	456

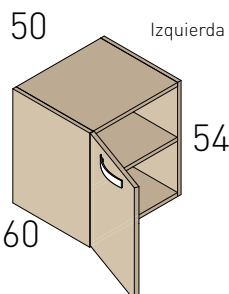

largo	referencia	puntos
50	MAJ35Z	141

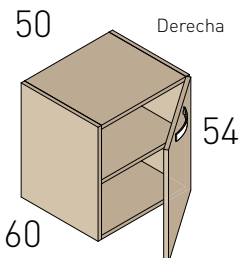

largo	referencia	puntos
50	MAJ35D	141

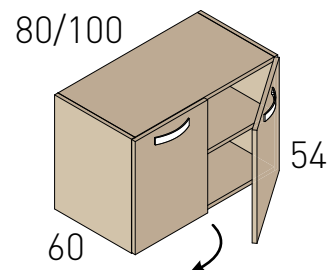

largo	referencia	puntos
80	MAJ38P	181
100	MAJ30P	199

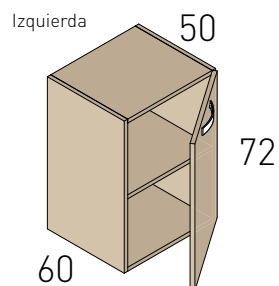

largo	referencia	puntos
50	MAJ45Z	151

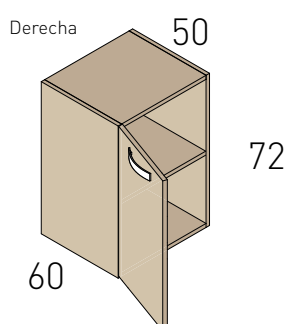

largo	referencia	puntos
50	MAJ45D	151

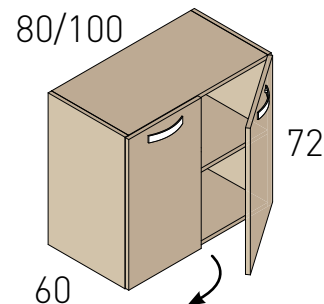

largo	referencia	puntos
80	MAJ48P	208
100	MAJ40P	222

* PARA REBAJE ZÓCALO INCREMENTAR 12 PUNTOS
max. 1cm de fondo

* IMPRESCINDIBLE INDICAR MEDIDA DE ZÓCALO

MÓDULOS BAJOS

Estructura y estantes de 1,9

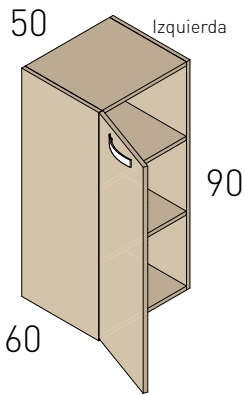

largo	referencia	puntos
50	MAJ55Z	180

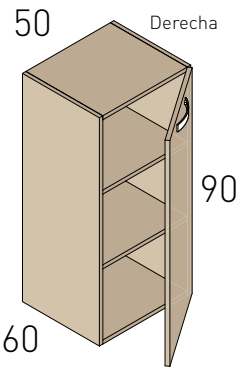

largo	referencia	puntos
50	MAJ55D	180

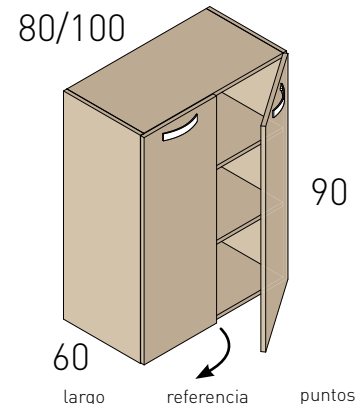

largo	referencia	puntos
80	MAJ58P	240
100	MAJ50P	272

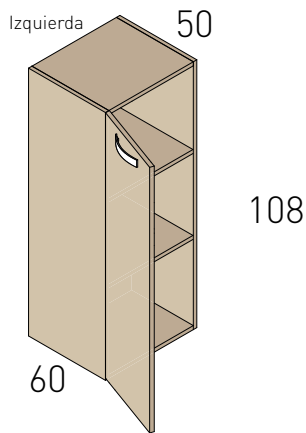

largo	referencia	puntos
50	MAJ65Z	210

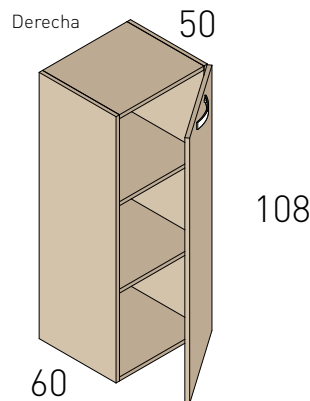

largo	referencia	puntos
50	MAJ65D	210

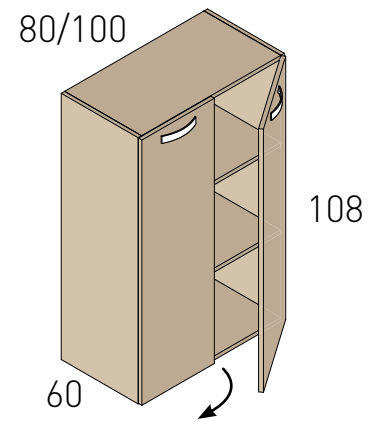

largo	referencia	puntos
80	MAJ68P	295
100	MAJ60P	307

* PARA REBAJE ZÓCALO INCREMENTAR 12 PUNTOS
max. 1cm de fondo

MODULOS A HUECO

CUBO INSIDE

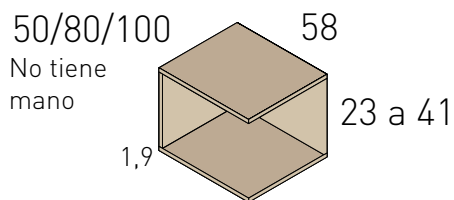

largo	referencia	puntos
50	CNS65	78
80	CNS68	104
100	CNS60	118

Necesario añadir partidor RIB a partir de 50

CUBO FUELLE

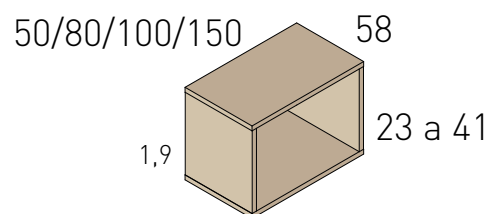

largo	referencia	puntos
50	CNF65	89
80	CNF68	120
100	CNF60	136
150	CNF615	174

Necesario añadir partidor RIB a partir de 100

PARTIDOR FUELLE RIB

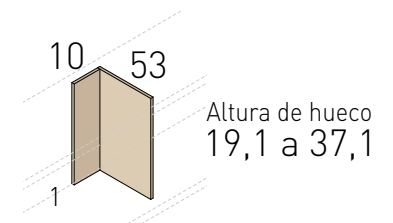

fondo	referencia	puntos
53	PRB53	25

Indicar medida altura

MÓDULOS ALTOS

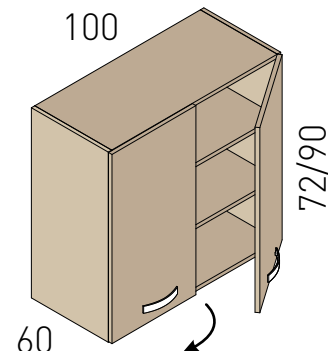
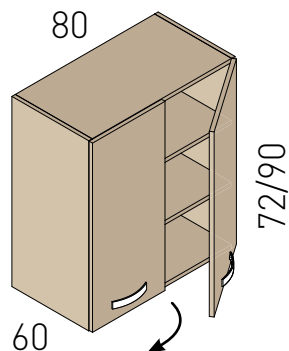
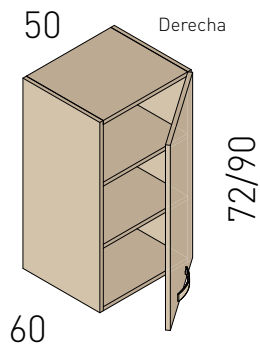
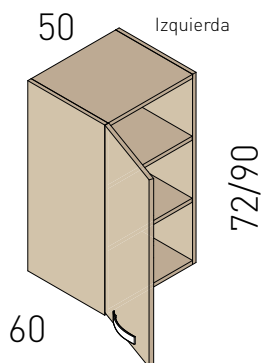

altura	referencia	puntos
72	MAH45Z	151
90	MAH55Z	185

altura	referencia	puntos
72	MAH45D	151
90	MAH55D	185

altura	referencia	puntos
72	MAH48P	208
90	MAH58P	245

altura	referencia	puntos
72	MAH40P	222
90	MAH50P	277

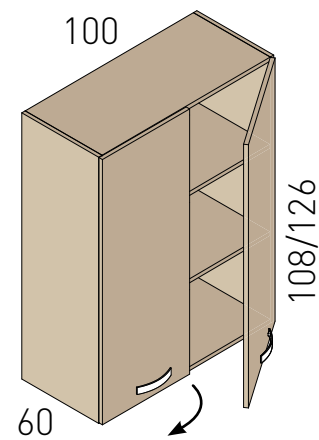
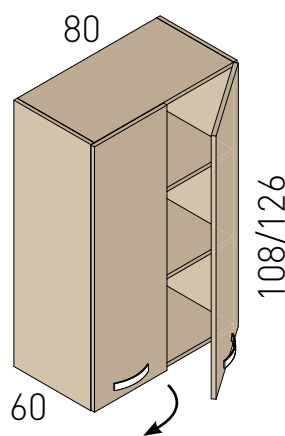
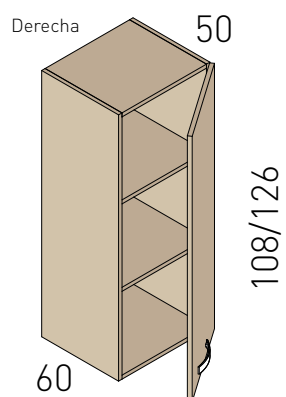
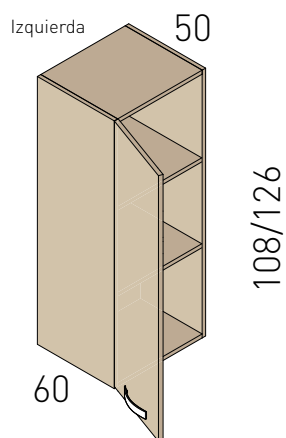

altura	referencia	puntos
108	MAH65Z	220
126	MAH75Z	248

altura	referencia	puntos
108	MAH65D	220
126	MAH75D	248

altura	referencia	puntos
108	MAH68P	280
126	MAH78P	310

altura	referencia	puntos
108	MAH60P	322
126	MAH70P	352

FORRO LATERAL

ESTANTE INTERIOR

Grueso 1cm

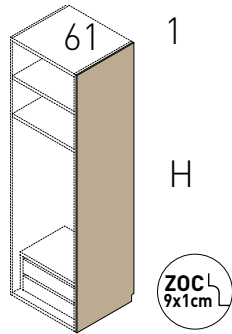

Grueso 1,9cm

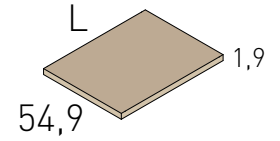
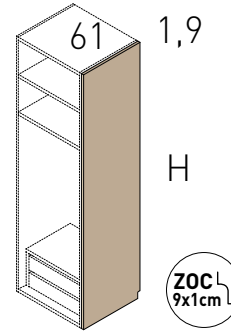

H	Acabados BASE		Acabados STONE	
	referencia	puntos	referencia	puntos
100	FR6110	26	FS6110	29
150	FR6115	42	FS6115	46
200	FR6120	46	FS6120	51
250	FR6125	58	FS6125	64
282	FR6128	65	FS6128	72

H	Acabados BASE		Acabados STONE	
	referencia	puntos	referencia	puntos
100	FR6210	31	FS6210	34
150	FR6215	46	FS6215	51
200	FR6220	58	FS6220	64
250	FR6225	76	FS6225	84
282	FR6228	82	FS6228	90

L	referencia	puntos
46,1	E646	29
76,1	E676	32
96,1	E696	35

Incremento 5 puntos por cada estante grueso 3cm

Forro con rebaje zócalo por defecto de 9x1cm

MÓDULO DIÁFANO FUELLE

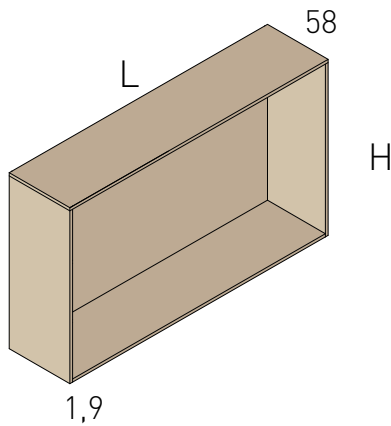

fondo	referencia	puntos/M2
58	DF60	152

puntos por m2 + puntos mínimo 100

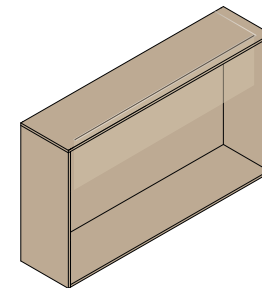

Indicar posición de interruptor izquierda o derecha

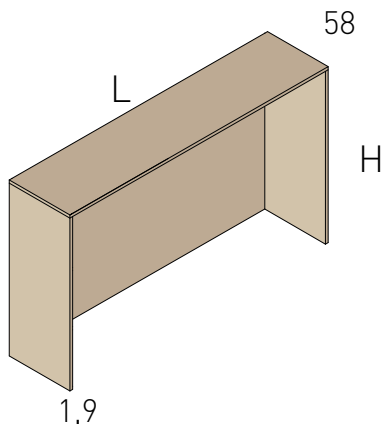

fondo	referencia	puntos/M2
58	DFB60	147

puntos por m2 + puntos mínimo 100

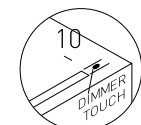
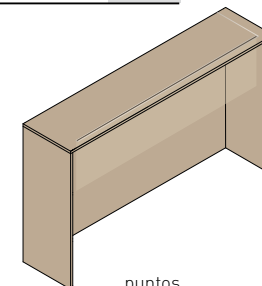

Indicar posición de interruptor izquierda o derecha



MESA SHOW 90 a 150 cm

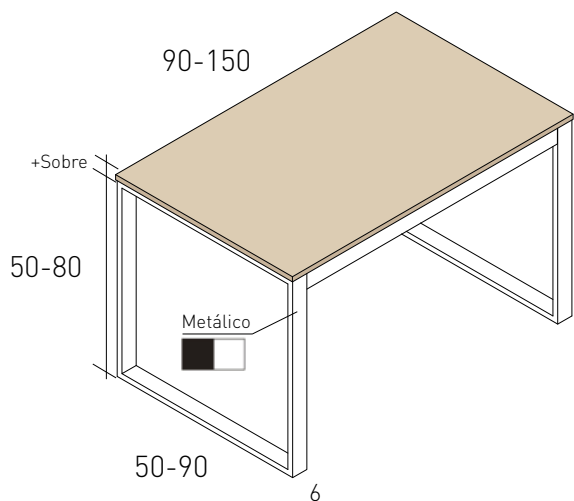

gr sobre	Acabados BASE		Acabados STONE		Estructura METÁLICA
	Ref	Ptos/m2	Ref	Ptos/m2	Puntos
10	MSH10	115	MSS10	126	+280
19	MSH19	65	MSS19	72	
30	MSH30	88			
50	MSH50	145			
Acabados					

El sobre sobrevuela 4 mm por cada lado.
Estructura metálica acabados unicolor +80 puntos.
Sobre de 10mm incluye sobre de 19mm interior en arena.
Para medidas fuera de rango indicado consultar fabrica.

MESA SHOW 150,1 a 250 cm

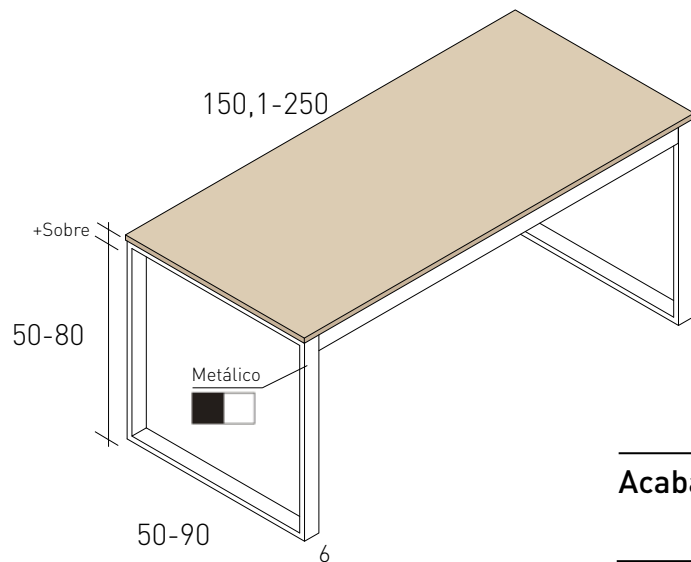

gr sobre	Acabados BASE		Acabados STONE		Estructura METÁLICA
	Ref	Ptos/m2	Ref	Ptos/m2	Puntos
10	MSH10	115	MSS10	126	+340
19	MSH19	65	MSS19	72	
30	MSH30	88			
50	MSH50	145			
Acabados					

El sobre sobrevuela 4 mm por cada lado.
Estructura metálica acabados unicolor +80 puntos.
Sobre de 10mm incluye sobre de 19mm interior en arena.
Para medidas fuera de rango indicado consultar fabrica.

EJEMPLO VALORACIÓN

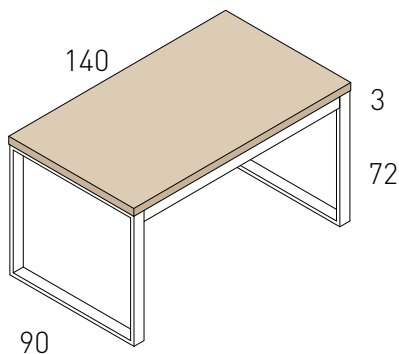

Mesa SHOW referencia **MSH30** medidas 150x90x75cm

Estructura metálica de 150x90x72cm:

280 puntos

Sobre grueso 30mm de 150x90 a 88puntos/m2:

119 puntos

Total **399** puntos

CABEZAL FRAMED



Panel Enmarcado



Tapizado



- Gruesos de 1,9cm enmarcado con tapas de 1cm.
- Rango de profundidad de 10 a 25cm.
- El enmarcado sobresale 2cm.
- Posibilidad de acoplar tablero tapizado: Lavable en seco o mediante paño húmedo sin productos.



- Envío desmontado facilita el transporte.

Profundidad de 10 a 25cm



Acabado con Veta Horizontal

Largo Máximo 282cm
Altura Máxima 165cm



Opción de Tablero Tapizado

CABEZAL WALL



Estructura Tapa



- Gruesos de 1,9cm.
- Rango de profundidad de 8 a 25cm.
- Para colocar tapa o visera led.
- La tapa sobresale 1cm y visera led 6cm.
- Led enrasada en parte inferior.



- Incluye sistema para fijar a pared.
- Envío desmontado facilita el transporte.

Profundidad de 8 a 25cm



Acabado con Veta Horizontal

Largo Máximo 282cm
Altura Máxima 165cm

Profundidad de 14 a 31cm



Tapa con Led

CABEZAL SET



Tapizado



Estructura Trasera



- Panel de 1,9cm separado 3cm de pared con opción para tapizado desenfundable.
- Estructura de 3cm de grueso trasera
- La estructura puede incorporar iluminación LED en su parte superior, generando efecto de luz indirecta
- Cabecal SET tapizado valorado por metro lineal. Altura máxima 125cm



- Incluye sistema para fijar a pared.
- Tapizado desenfundable y lavable

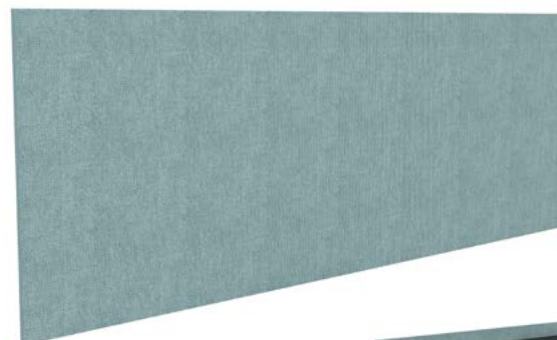

CABEZAL DUE



Tapizado

Estructura Trasera



- Formado por 2 paneles de 1,9cm con opción para tapizado desenfundable y una pieza trasera de unión de 3cm de grueso (únicamente acabado base)
- La estructura puede incorporar iluminación LED en su parte superior, generando efecto de luz indirecta
- Cabezal DUE tapizado valorado por metro lineal. Altura máxima 125cm



- Incluye sistema de fijar a pared
- Tapizado desenfundable y lavable

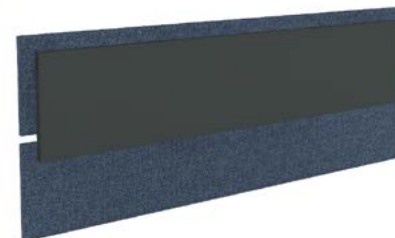

CABEZAL SLAT



Panel trasero
Tiras frontales



- Panel trasero de 1,9cm preparado para colgar
- Tiras de 3cm de grueso y 7cm de profundidad. Por defecto espaciados 6cm aproximadamente
- Para distribuciones especiales consultar con fábrica



- Incluye sistema para fijar a pared.
- Envió desmontado facilita el transporte.
- Opcion rebaje zócalo máximo 1cm profundidad



CABEZAL STRIP



Panel trasero
Tiras frontales



- Panel trasero de 1,9cm preparado para colgar
- Piezas de 7cm de ancho y 1,9cm de grueso. Por defecto espaciados 7cm aproximadamente
- Para distribuciones especiales consultar con fábrica



- Incluye sistema para fijar a pared.
- Envió desmontado facilita el transporte.
- Opcion rebaje zócalo máximo 1cm profundidad



CABEZAL ARCÓN



Estructura
Tapa
Carro Extraible



- Cabecal arcón con 2 modelos, para cama individual o para cama doble
- Con puerta para acceder al espacio superior, y con carro extraible formato estantería oculto en el interior.



- Envío desmontado facilita el transporte.

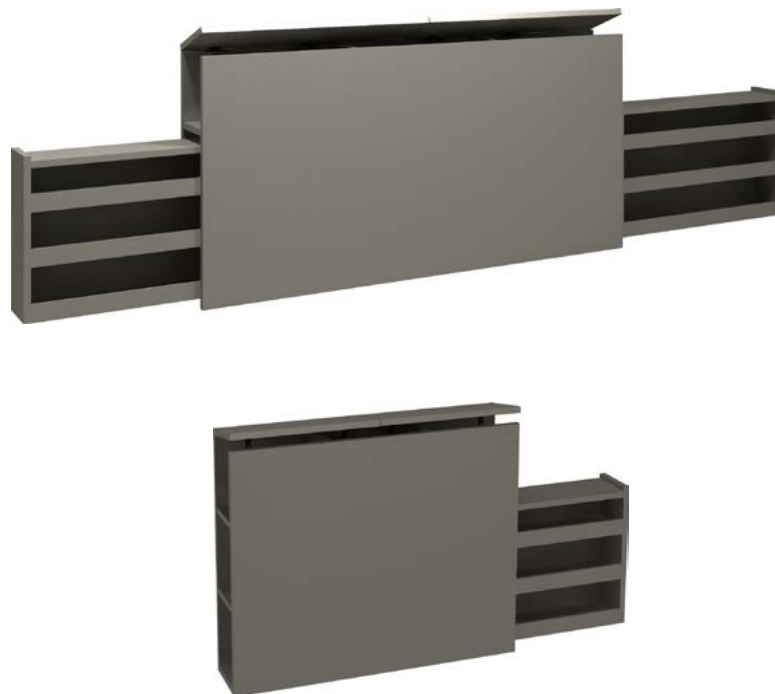

ESPECIALES CAMAS Y CANAPES

ESPECIALES GENERALES

MODIFICACIÓN DIMENSIONES (Norma general se aplica si no existe norma específica)
AUMENTAR SÓLO CUANDO NO EXISTA REFERENCIA SUPERIOR

RECORTAR

PUNTOS BASE REFERENCIA DE MEDIDA SUPERIOR +15%

POR REDUCIR VARIAS DIMENSIONES A LA VEZ SE APLICARÁ UN SOLO INCREMENTO DEL 15%

AUMENTAR DIMENSIONES HASTA UN 10%

PUNTOS BASE REFERENCIA DE MEDIDA MÁXIMA +25%

POR AUMENTAR VARIAS DIMENSIONES A LA VEZ SE APLICARÁ UN SOLO INCREMENTO DEL 25%

ESPECIALES ESPECÍFICOS

Ranuras adicionales para colocación de led (puntos mínimos 20) +20 p/ml

Encastes zócalo imprescindible especificar la medida

LISO Grueso 1,9



Largo máx. 282
Acabado STONE
Largo máx. 277

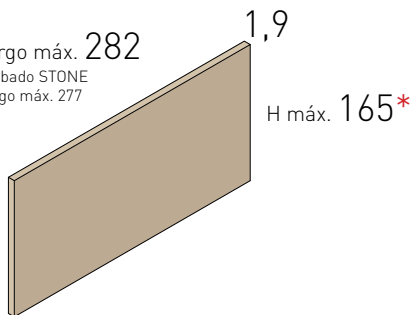

BASE	
Sin rebaje zócalo	
ref.	puntos/M2
AMC	64
puntos mínimos 32	

Con rebaje zócalo *	
ref.	puntos/M2
AMC-Z	76
puntos mínimos 38	



STONE	
Largo máx. 277	
Sin rebaje zócalo	
ref.	puntos/M2
AMS	71
puntos mínimos 36	

Con rebaje zócalo *	
ref.	puntos/M2
AMS-Z	83
puntos mínimos 42	



puntos por m2

*** H MÁX. SUPERIOR
CONSULTAR CON
FÁBRICA**

LISO Grueso 3



Largo máx. 282

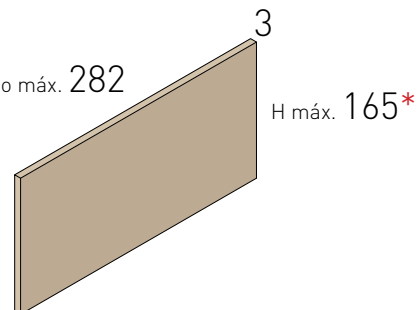

BASE	
Sin rebaje zócalo	
ref.	puntos/M2
AM3	80
puntos mínimos 40	

Con rebaje zócalo *	
ref.	puntos/M2
AM3-Z	92
puntos mínimos 46	



LISO Grueso 5



Largo máx. 282

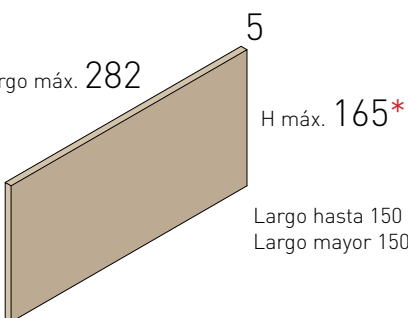

Largo hasta 150 cm macizo
Largo mayor 150 cm atamborado

BASE	
Sin rebaje zócalo	
ref.	puntos/M2
AM5	104
puntos mínimos 52	
Con rebaje zócalo *	
ref.	puntos/M2
AM5-Z	116
puntos mínimos 58	



puntos por m2

*** H MÁX. SUPERIOR
CONSULTAR CON
FÁBRICA**

LISO Grueso 5 con led



Largo máx. 282

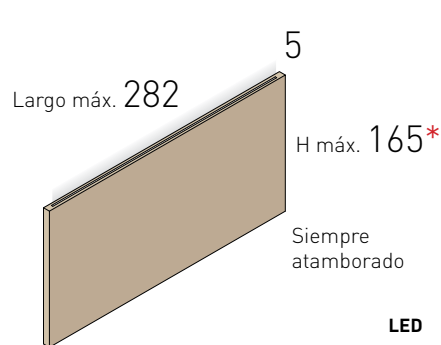

Siempre atamborado

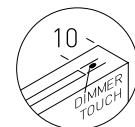

Indicar posición de interruptor izquierda o derecha



LED	
largo	puntos
50 a 150	120
150,1 a 250	160

Puntos = Cabezal en M2 + Largo LED

+



RÚSTICO grueso 1,9

RÚSTICO grueso 3

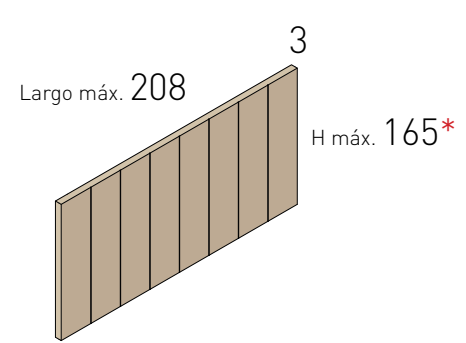
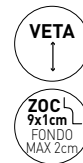
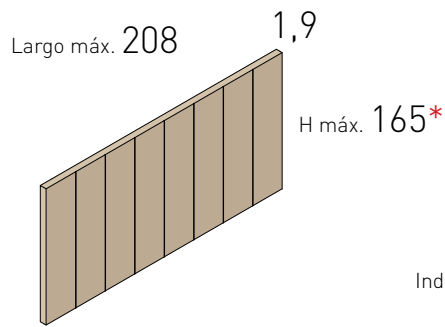
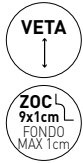

Indicar color ranura / Ranuras cada 20-25cm
INCREMENTO
POR RANURA ADICIONAL +7

BASE		STONE	
Sin rebaje zócalo		Sin rebaje zócalo	
ref.	puntos/M2	ref.	puntos/M2
CTB2	82	CTS2	89
puntos mínimos 44		puntos mínimos 45	
Con rebaje zócalo *		Con rebaje zócalo *	
ref.	puntos/M2	ref.	puntos/M2
CTB2-Z	100	CTS2-Z	107
puntos mínimos 50		puntos mínimos 54	

BASE	
Sin rebaje zócalo	
ref.	puntos/M2
CTB3	106
puntos mínimos 53	
Con rebaje zócalo *	
ref.	puntos/M2
CTB3-Z	118
puntos mínimos 59	

RÚSTICO grueso 5

RÚSTICO grueso 5 con led

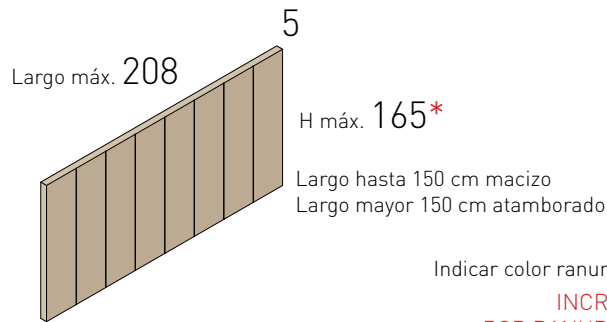
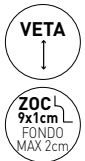

Largo hasta 150 cm macizo
Largo mayor 150 cm atamborado

Indicar color ranura / Ranuras cada 20-25cm
INCREMENTO
POR RANURA ADICIONAL +7

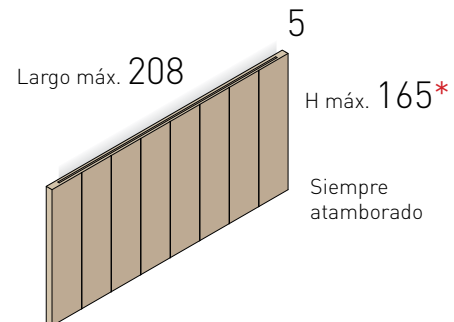
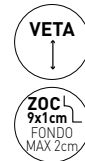

Siempre atamborado

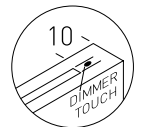

Indicar posición de interruptor izquierda o derecha

BASE	
Sin rebaje zócalo	
ref.	puntos/M2
CTB	127
puntos mínimos 65	
Con rebaje zócalo *	
ref.	puntos/M2
CTB-Z	139
puntos mínimos 70	

*** H MÁX. SUPERIOR
CONSULTAR CON
FÁBRICA**

BASE	
Sin rebaje zócalo	
ref.	puntos/M2
CTBL	133
puntos mínimos 65	
Con rebaje zócalo *	
ref.	puntos/M2
CTBL-Z	145
puntos mínimos 70	

Puntos = Cabezal en M2 + Largo LED

LED	
largo	puntos
50 a 150	120
150,1 a 250	160

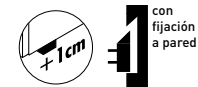

FRAMED (fondo variable)

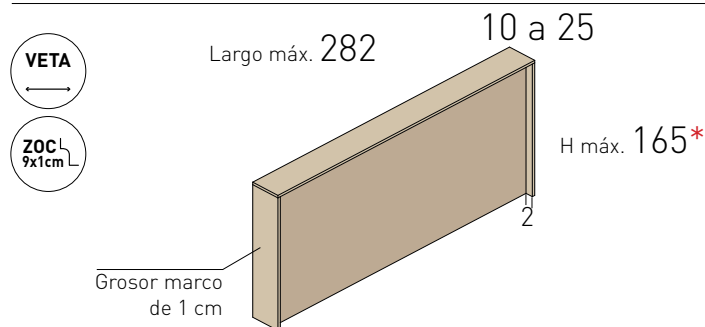

BASE		STONE	
Sin rebaje zócalo		Sin rebaje zócalo	
ref.	puntos/M2	ref.	puntos/M2
CFR	108	CFS	120
puntos mínimos 54		puntos mínimos 60	
Con rebaje zócalo *		Con rebaje zócalo *	
ref.	puntos/M2	ref.	puntos/M2
CFR-Z	120	CFS-Z	132
puntos mínimos 60		puntos mínimos 66	

Complemento Tapizado

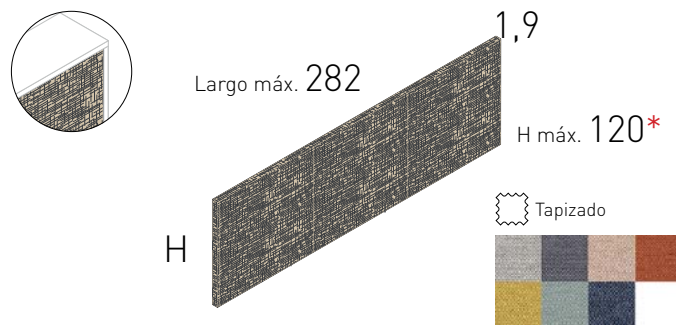

ref.	puntos/M2	
CFT	230	puntos por m2
puntos mínimos 230		

WALL (fondo variable)

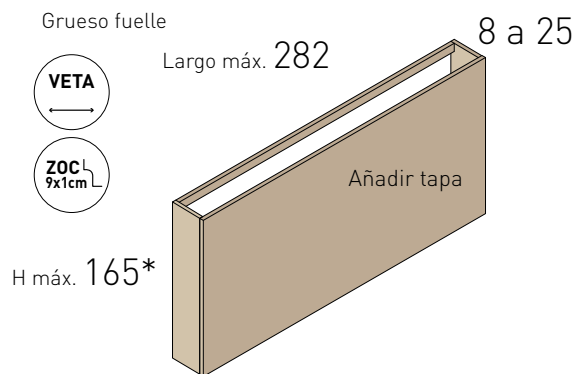

BASE		STONE	
Sin rebaje zócalo		Sin rebaje zócalo	
ref.	puntos/M2	ref.	puntos/M2
CLV	92	CLVS	102
puntos mínimos 46		puntos mínimos 51	
Con rebaje zócalo *		Con rebaje zócalo *	
ref.	puntos/M2	ref.	puntos/M2
CLV-Z	104	CLVS-Z	114
puntos mínimos 52		puntos mínimos 57	

TAPA enrasada o visera

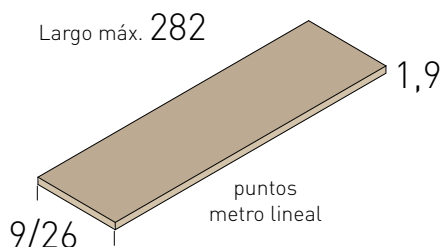

BASE		STONE	
ref.	puntos/ML	ref.	puntos/ML
CLT	25	CLTS	28
puntos mínimos 15		puntos mínimos 15	

VISERA con led

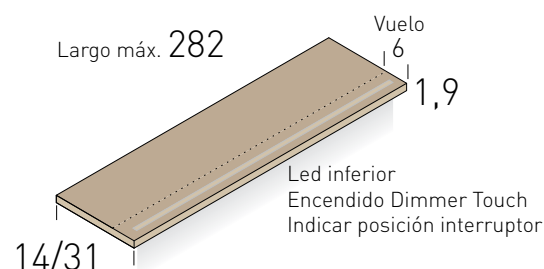

BASE		STONE	
ref.	puntos/ML	ref.	puntos/ML
CLL	32	CLLS	35
puntos mínimos 32		puntos mínimos 15	

LED	
largo	puntos
50 a 150	120
150,1 a 250	160

Puntos = Visera metro lineal + Largo LED

* H MÁX. SUPERIOR CONSULTAR CON FÁBRICA

* IMPRESCINDIBLE INDICAR MEDIDA DE ZÓCALO



Cabezal SET Grueso 4,9

Led para Cabezal SET

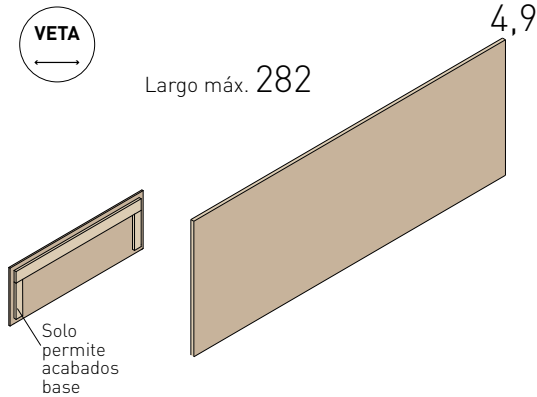

H máx. 165*

*** H MÁX. 165
PARA ACABADOS BASE Y STONE
PARA TAPIZADO MAX 120
OTRAS CONSULTAR CON FÁBRICA**

puntos por m2
excepto tapizados en ml

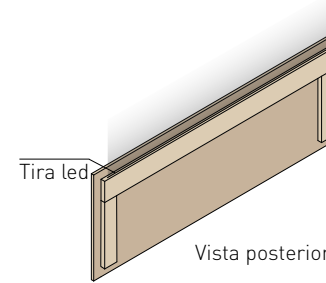

Led interior
Encendido Dimmer Touch
Indicar posición interruptor



Puntos = Puntos cabezal + largo LED

LED		largo	puntos
		50 a 150	120
		150,1 a 250	160

BASE

ref.	puntos/M2
C49	102
puntos mínimos 51	



TAPIZADO

Alto máx. 120

ref.	puntos/ML
C49T	250
puntos mínimos 125	

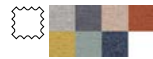

STONE

Largo máx. 277

ref.	puntos/M2
C49S	110
puntos mínimos 55	



BASE

ref.	puntos/M2
C49L	106
puntos mínimos 53	



TAPIZADO

Alto máx. 120

ref.	puntos/ML
C49LT	254
puntos mínimos 127	



STONE

Largo máx. 277

ref.	puntos/M2
C49LS	114
puntos mínimos 57	



Cabezal DUE Grueso 4,9

Led para cabezal DUE

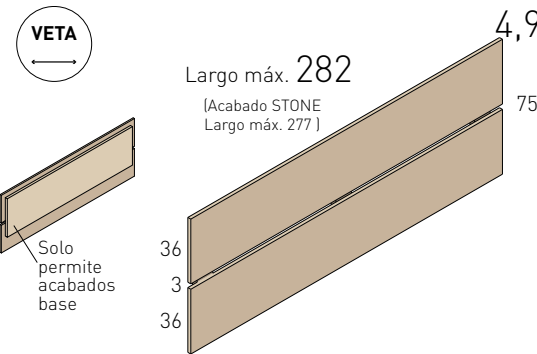

[Acabado STONE
Largo máx. 277]

puntos por m2
excepto tapizados en ml

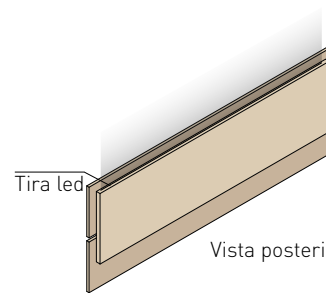

Led interior
Encendido Dimmer Touch
Indicar posición interruptor



Puntos = Puntos cabezal + largo LED

LED		largo	puntos
		50 a 150	120
		150,1 a 250	160

BASE

ref.	puntos/M2
DUE	102
puntos mínimos 51	



TAPIZADO

Alto máx. 120

ref.	puntos/ML
DUET	250
puntos mínimos 125	

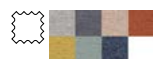

STONE

Largo máx. 277

ref.	puntos/M2
DUES	110
puntos mínimos 55	



BASE

ref.	puntos/M2
DULE	106
puntos mínimos 53	



TAPIZADO

Alto máx. 120

ref.	puntos/ML
DULET	254
puntos mínimos 127	



STONE

Largo máx. 277

ref.	puntos/M2
DULES	114
puntos mínimos 57	





ARCÓN 2 carros

Cojín

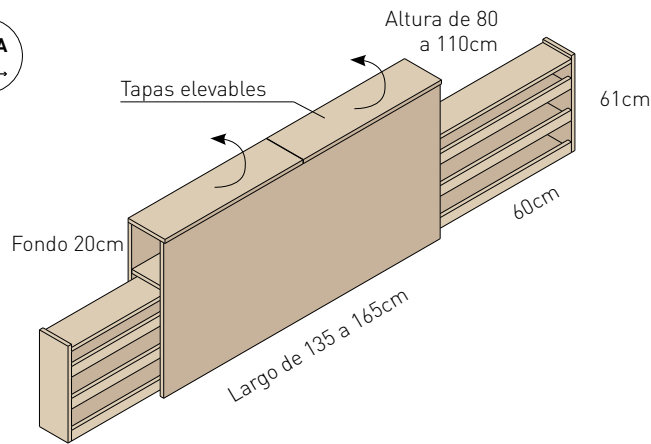

BASE

ref.	puntos/M2
A2C	412

puntos por m2

puntos mínimos 290

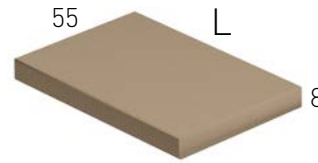

Acabados TAPIZADO

L	referencia	puntos
50	CJ50	180
80	CJ80	200
100	CJ10	220
120	CJ12	240
140	CJ14	260



L	referencia	puntos
50	CJ450	153
80	CJ480	170
100	CJ410	187
120	CJ412	204
140	CJ414	221

Mesa SHITAKE M

Mesa SHITAKE L

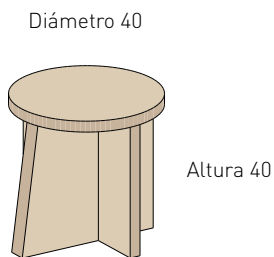

BASE

ref.	puntos
TB40	92

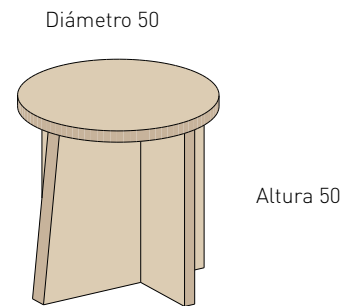

BASE

ref.	puntos
TB50	102

CARACTERÍSTICAS ESPECÍFICAS CAMA GOA



- Piezas de grueso 5cm.
- Somier no incluido.
- Se incorpora travesaño de refuerzo para somier de 135 y 150.
- Elección de patas por separado.
- Tapizado desfundable y lavable.



- Envío desmontado facilita el transporte.
- Montaje sencillo y rápido.



CAMA GOA PATA TUB

Grueso 5cm / Somier NO incluido

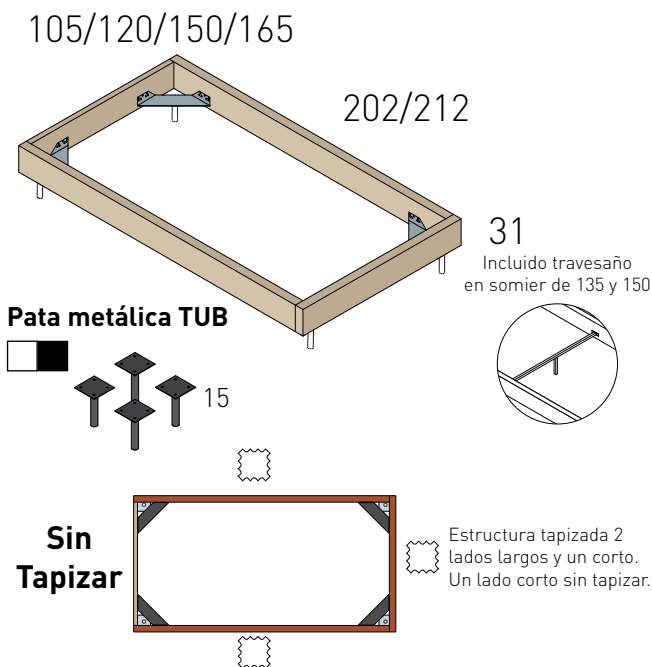

Colchón	Ref	Puntos	TAPIZADO	
			Ref	Puntos
190x90	GOAT/4	306	GOAT/4T	576
190x105	GOAT/6	315	GOAT/6T	585
190x135	GOAT/8	353	GOAT/8T	623
190x150	GOAT/10	377	GOAT/10T	647
200x90	GOAT/21	312	GOAT/21T	582
200x105	GOAT/22	321	GOAT/22T	591
200x135	GOAT/23	369	GOAT/23T	639
200x150	GOAT/24	383	GOAT/24T	653
Acabados				

CAMA GOA PATA OSLO

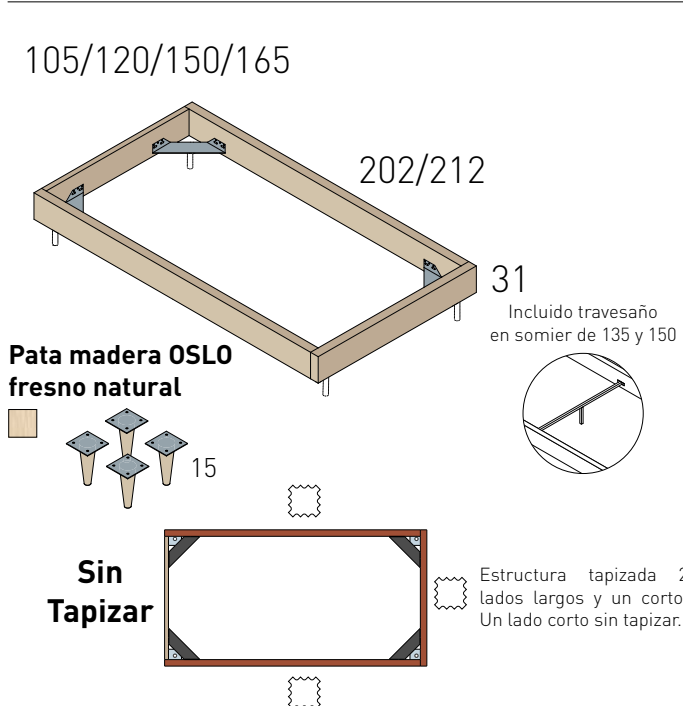

Colchón	Ref	Puntos	TAPIZADO	
			Ref	Puntos
190x90	GOAS/4	326	GOAS/4T	596
190x105	GOAS/6	335	GOAS/6T	605
190x135	GOAS/8	373	GOAS/8T	643
190x150	GOAS/10	397	GOAS/10T	667
200x90	GOAS/21	332	GOAS/21T	602
200x105	GOAS/22	351	GOAS/22T	621
200x135	GOAS/23	389	GOAS/23T	659
200x150	GOAS/24	403	GOAS/24T	673
Acabados				



CARACTERÍSTICAS ESPECÍFICAS CANAPÉ APERTURA FRONTAL



- Piezas de grueso 3cm.
- Todo cerrado.
- Somier lamas o tapizado incluido.
- Hueco interior útil 30cm altura.
- Apertura somier 90cm.
- Se incorpora travesaño como refuerzo para somier de 135 y 150.
- Tapizado desfundable y lavable.



- Envío desmontado facilita el transporte.
- Montaje sencillo y rápido.
- Mejora estructural en la base para facilitar montaje en horizontal.



Somier tapizado



Somier Lamas

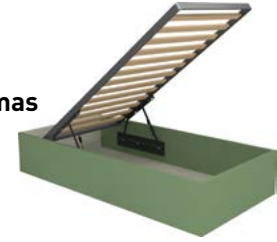

CANAPÉ ELEVABLE FRONTAL SOMIER LAMAS

Grueso 5cm / Somier incluido

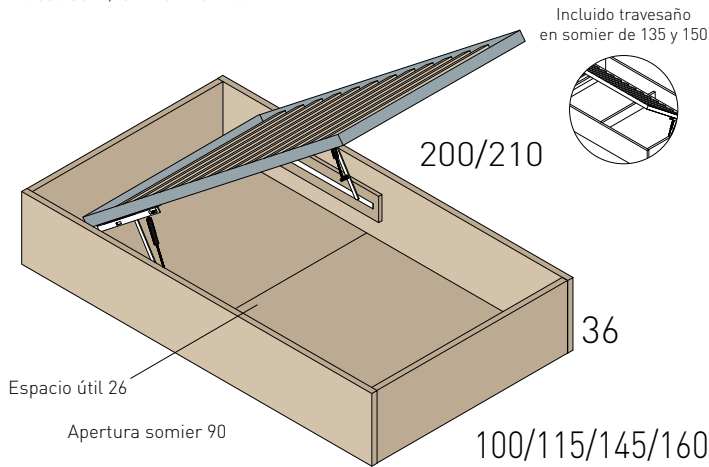

Sin Tapizar

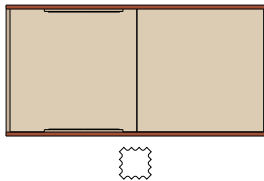

Estructura tapizada 2 lados largos y un corto. Un lado corto sin tapizar.

ESTRUCTURA TAPIZADA

Colchón	Ref	Puntos	Ref	Puntos
190x90	CEF/4	437	CEF/4T	707
190x105	CEF/6	489	CEF/6T	759
190x135	CEF/8	591	CEF/8T	861
190x150	CEF/10	614	CEF/10T	884
200x90	CEF/21	468	CEF/21T	738
200x105	CEF/22	508	CEF/22T	778
200x135	CEF/23	637	CEF/23T	907
200x150	CEF/24	678	CEF/24T	984

Acabados

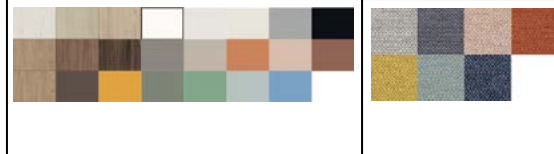

CANAPÉ ELEVABLE FRONTAL SOMIER TAPIZADO

Grueso 5cm / Somier tapizado incluido

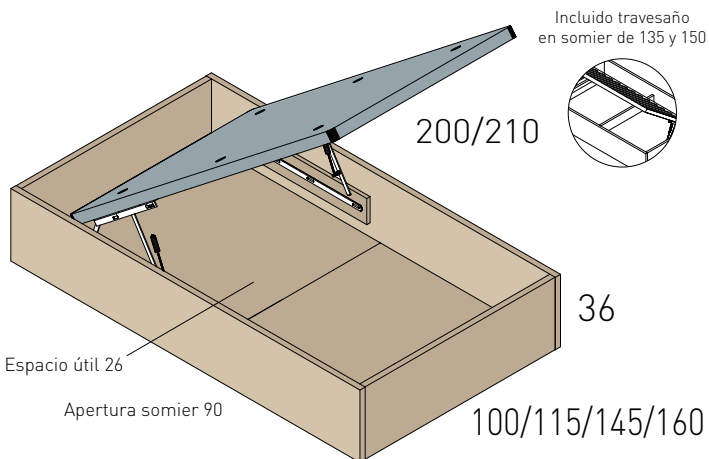

Sin Tapizar

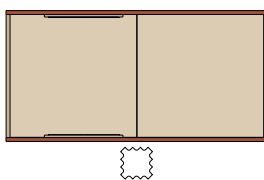

Estructura tapizada 2 lados largos y un corto. Un lado corto sin tapizar.

ESTRUCTURA TAPIZADA

Colchón	Ref	Puntos	Ref	Puntos
190x90	CEFT/4	492	CEFT/4T	762
190x105	CEFT/6	544	CEFT/6T	814
190x135	CEFT/8	646	CEFT/8T	916
190x150	CEFT/10	669	CEFT/10T	939
200x90	CEFT/21	523	CEFT/21T	793
200x105	CEFT/22	563	CEFT/22T	833
200x135	CEFT/23	692	CEFT/23T	962
200x150	CEFT/24	733	CEFT/24T	1003

Acabados

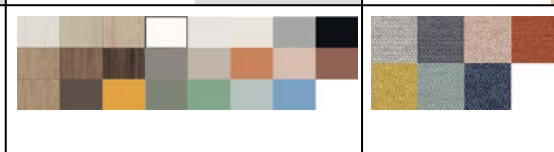

CARACTERÍSTICAS ESPECÍFICAS CANAPÉ APERTURA LATERAL



- Piezas de grueso 3cm.
- Todo cerrado.
- Somier lamas o tapizado incluido.
- Hueco interior útil 30cm altura.
- Apertura somier 90cm.
- Se incorpora travesaño como refuerzo para somier de 135 y 150.
- Tapizado desenfundable y lavable.



- Envío desmontado facilita el transporte.
- Montaje sencillo y rápido.
- Mejora estructural en la base para facilitar montaje en horizontal.

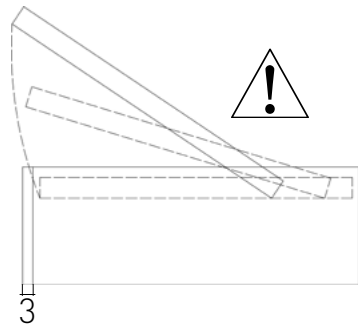

- El somier al abrirse sobresale de la vertical 3cm hacia fuera



CANAPÉ ELEVABLE LATERAL SOMIER LAMAS

Grueso 5cm / Somier incluido

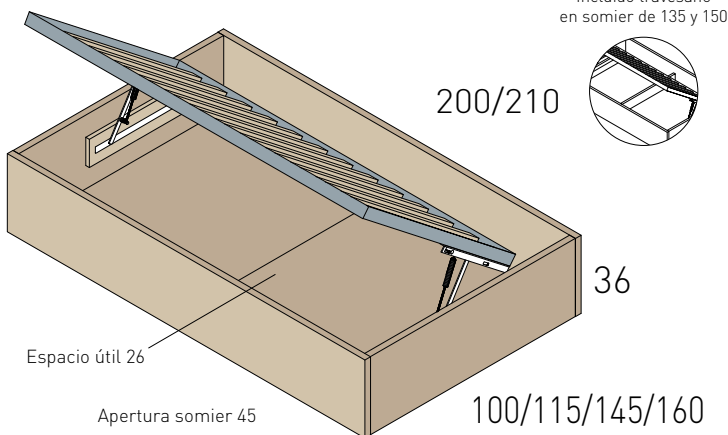

Sin Tapizar

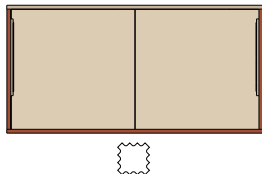

Estructura tapizada 2 lados cortos y un largo. Un lado largo sin tapizar.

ESTRUCTURA TAPIZADA

Colchón	Ref	Puntos	Ref	Puntos
190x90	CEL/4	437	CEL/4T	707
190x105	CEL/6	489	CEL/6T	759
190x135	CEL/8	591	CEL/8T	861
190x150	CEL/10	614	CEL/10T	884
200x90	CEL/21	468	CEL/21T	738
200x105	CEL/22	508	CEL/22T	778
200x135	CEL/23	637	CEL/23T	907
200x150	CEL/24	678	CEL/24T	984

Acabados

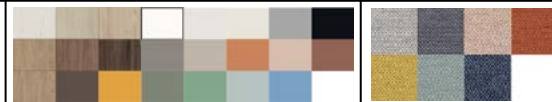

CANAPÉ ELEVABLE LATERAL SOMIER TAPIZADO

Grueso 5cm / Somier incluido

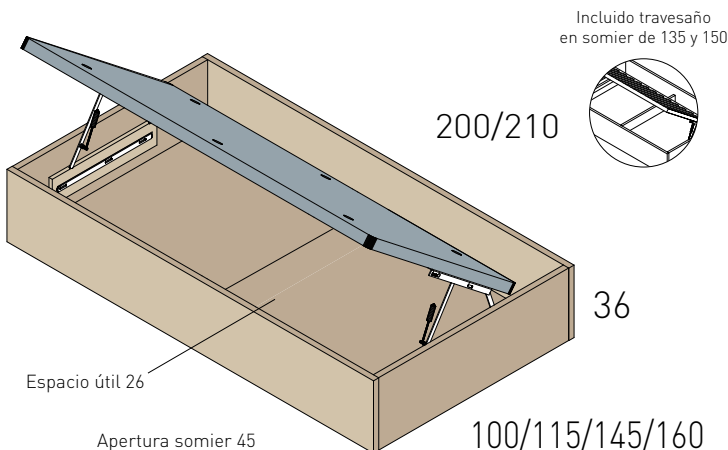

Sin Tapizar

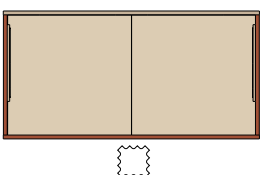

Estructura tapizada 2 lados cortos y un largo. Un lado largo sin tapizar.

ESTRUCTURA TAPIZADA

Colchón	Ref	Puntos	Ref	Puntos
190x90	CELT/4	492	CELT/4T	762
190x105	CELT/6	544	CELT/6T	814
190x135	CELT/8	638	CELT/8T	908
190x150	CELT/10	669	CELT/10T	939
200x90	CELT/21	523	CELT/21T	793
200x105	CELT/22	563	CELT/22T	833
200x135	CELT/23	684	CELT/23T	954
200x150	CELT/24	733	CELT/24T	1003

Acabados



ESPECIALES MÓDULOS LIBRE CONFIGURACIÓN

ESPECIALES GENERALES

MODIFICACIÓN DIMENSIONES (Norma general se aplica si no existe norma específica)
AUMENTAR SÓLO CUANDO NO EXISTA REFERENCIA SUPERIOR

RECORTAR	
PUNTOS BASE REFERENCIA DE MEDIDA SUPERIOR	+15%
POR REDUCIR VARIAS DIMENSIONES A LA VEZ SE APLICARÁ UN SOLO INCREMENTO DEL 15%	

AUMENTAR DIMENSIONES HASTA UN 10%	
PUNTOS BASE REFERENCIA DE MEDIDA MÁXIMA	+25%
POR AUMENTAR VARIAS DIMENSIONES A LA VEZ SE APLICARÁ UN SOLO INCREMENTO DEL 25%	

ESPECIALES ESPECÍFICOS

TODOS LOS MODELOS DE MÓDULOS

Aumentar fondo, exclusivamente, a 50cm	+10%
Aumentar fondo, exclusivamente, a 58cm	+15%
Aumentar fondo +58cm	Consultar fábrica
Aumentar altura hasta 75cm para salvar radiador	+ 20 puntos
Cajeado de módulo	95 puntos por cajeo
Sustituir 2 cajones de 18cm por un cajón contenedor	+15 puntos
Ranuras para colocación de led (puntos mínimos 20)	+20 p/ml
Cremallera (puntos mínimos 15)	+15 p/ml

TAPAS PARA MÓDULOS DE GRUESO 1, 1.9 y 3 cm

Aumentar fondo hasta 50,2cm	+10%
Aumentar fondo hasta 50,2cm	+15%
Aumentar fondo superiores a 58,2cm	Consultar fábrica

TAPA PARA MÓDULOS DE GRUESO 5 cm

Aumentar fondo hasta 50,2cm	+15%
Aumentar fondo hasta 58,2cm	+20%
Aumentar fondo superiores a 58,2cm	Consultar fábrica

GUÍAS PUSH EXTRACCIÓN TOTAL

Por cada cajón con guías push extracción total Imprescindible forro perimetral (tapas y costados) añadiendo 4 milímetros mas que el fondo de los módulos.	+6 puntos
--	-----------

**CONSULTAR CON FÁBRICA ESPECIALES NO DEFINIDOS
PARA SU VALORACIÓN Y VIABILIDAD TÉCNICA**

Nuevos módulos creados para poder realizar composiciones libres con tapa, base y forros a costados, creando un cerramiento y ampliando las posibilidades de utilización en salones, comedores y dormitorios.

MÓDULOS LIBRE CONFIGURACIÓN



**Estructura
Frente Cajón**



- Interior cajón en arena.
- Módulos de 18, 36, 54 y 72cm de altura. Para otras medidas consultar con fábrica.
- Es necesario añadir tapa y base individual o conjunta.
- Se pueden añadir forros a costados.
- Disponibles con cajones, puertas y diafanos.
- Todos los cajones de 18 cm.
- Guías de **extracción total** y autocierre amortiguado
- Guía oculta.
- El color de cada cajón se define individualmente.
- El modelo y color de cada tirador se define individualmente.



- Alturas y profundidad de las cubetas en función de las medidas del módulo.



- Medida mínima de fondo de módulo con cajones 33cm, profundidad cubeta de 26,4cm.



Profundidad cubeta según profundidad módulo

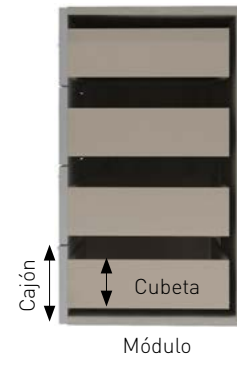

Altura cubeta según altura frente cajón

Desde	Hasta	Fondo Cubeta
370	420	314
420	470	364
470	520	414
520	570	464
570	770	514

Alt. Cajón Desde	Alt. Cajón Hasta	Altura Cubeta
120	149	70
150	169	90
170	219	110
220	279	160
280	369	220
>370	-	310



- Frentes con 2mm de holgura superior e inferior, 2mm lateral y holgura de 4mm entre cajones.
- Altura total cajón a suelo de 2mm.
- Se sirve sin taco.



MARCO: TAPAS Y FORROS



Tapas



- Posibilidad de colocar forros a costados creando un marco de 1 o 1,9cm de grueso.
- Forros siempre interiores.
- Tapas y forros se sirven sin mecanizar.

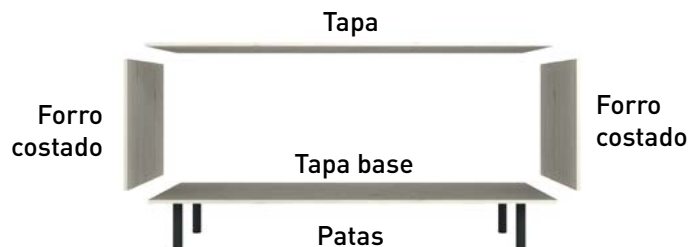

PATAS



OSLO Fresno natural

TUB Metálico



- Se recomienda añadir una pata central a partir 150cm.



- La responsabilidad final del número de patas elegidas para montaje será siempre del cliente.



EJEMPLOS



SUSTITUCIÓN DE GUÍAS CAJÓN

Sustitución de guías de extracción total a:

guías	puntos/cajón
Push extracción total *	sin/inc

* Imprescindible forro perimetral (tapas y costados) Debido al sistema de expulsión el fondo total del módulo se incrementa 4 mm. Ver página 321.

Ejemplo: Para módulos de 44cm de fondo, tapas y forros de 44.6cm.

Importante para composiciones que utilicen otros elementos sin guía PUSH ya que mantendrán su medida original de fondo.

Añadir tapa pag 319

Se sirven sin tacos

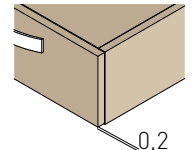

40/50/60/80/100

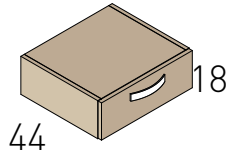

largo	referencia	puntos
40	MCL141	106
50	MCL151	113
60	MCL161	120
80	MCL181	134
100	MCL101	148

40/50/60/80

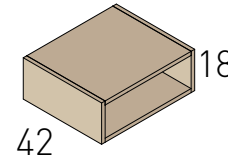

largo	referencia	puntos
40	MCL140	56
50	MCL150	62
60	MCL160	70
80	MCL180	78

100/120

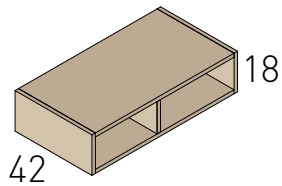

largo	referencia	puntos
100	MCL100	98
120	MCL120	120

40/50/60/80/100

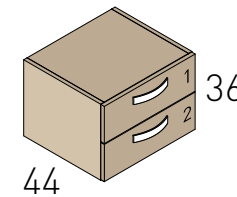

largo	referencia	puntos
40	MCL242	151
50	MCL252	158
60	MCL262	165
80	MCL282	190
100	MCL202	215

40/50/60/80

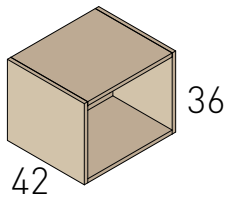

largo	referencia	puntos
40	MCL240	62
50	MCL250	70
60	MCL260	82
80	MCL280	98

100/120

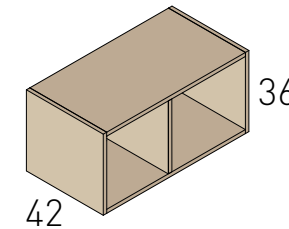

largo	referencia	puntos
100	MCL200	120
120	MCL220	132

40/50/60/80

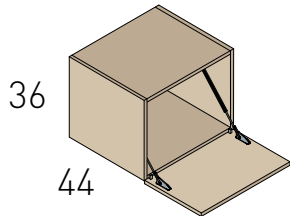

largo	referencia	puntos
40	MCL24A	114
50	MCL25A	122
60	MCL26A	132
80	MCL28A	144

100/120

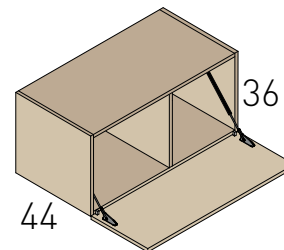

largo	referencia	puntos
100	MCL20A	164
120	MCL22A	178

40/50/60/80/100/120

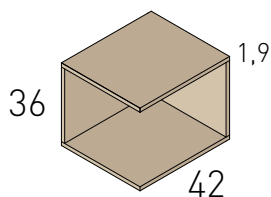

CUBO INSIDE

largo	referencia	puntos
40	CNS44	58
50	CNS45	66
60	CNS46	77
80	CNS48	92
100	CNS40	104
120	CNS42	118

No tiene mano
Imprescindible añadir
partidor RIB a partir de 80cm

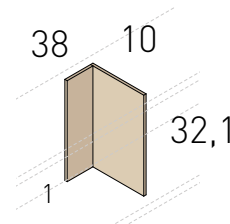

PARTIDOR FUELLE RIB

referencia	puntos
PRB38	23

Para frentes acabado Stone añadir 8 puntos/m2, con un mínimo de 2 puntos por pieza

Añadir tapa pag 319

Se sirven sin tacos

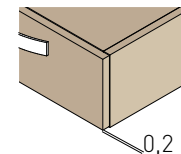

Izquierda 40/50/60

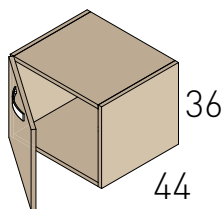

largo	referencia	puntos
40	MCL24Z	106
50	MCL25Z	114
60	MCL26Z	122

Derecha 40/50/60

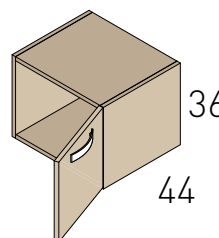

largo	referencia	puntos
40	MCL24D	106
50	MCL25D	114
60	MCL26D	122

40/50/60/80/100

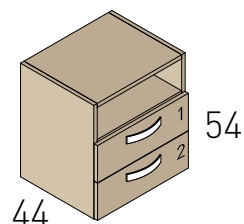

largo	referencia	puntos
40	MCL342	158
50	MCL352	165
60	MCL362	175
80	MCL382	199
100	MCL302	225

40/50/60/80/100

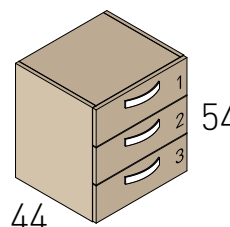

largo	referencia	puntos
40	MCL343	196
50	MCL353	203
60	MCL363	214
80	MCL383	246
100	MCL303	282

40/50/60/80/100

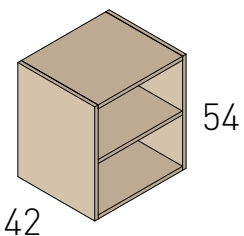

largo	referencia	puntos
40	MCL340	95
50	MCL350	99
60	MCL360	103
80	MCL380	108
100	MCL300	113

80/100

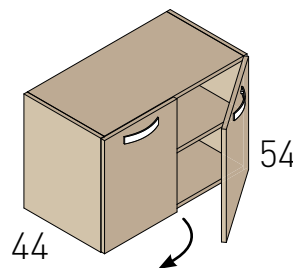

largo	referencia	puntos
80	MCL38P	153
100	MCL30P	167

Izquierda 40/50/60

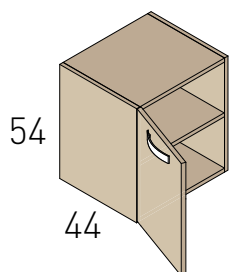

largo	referencia	puntos
40	MCL34Z	119
50	MCL35Z	127
60	MCL36Z	135

Derecha 40/50/60

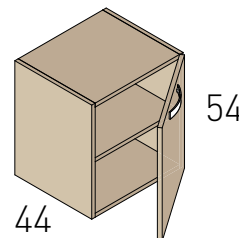

largo	referencia	puntos
40	MCL34D	119
50	MCL35D	127
60	MCL36D	135

Añadir tapa pag 319

Se sirven sin tacos

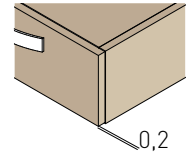

40/50/60/80/100

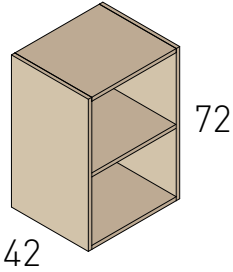

largo	referencia	puntos
40	MCL440	101
50	MCL450	105
60	MCL460	109
80	MCL480	117
100	MCL400	125

40/50/60/80/100

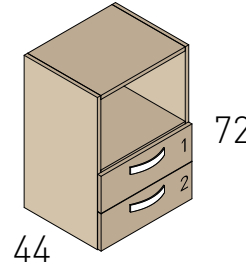

largo	referencia	puntos
40	MCL442	182
50	MCL452	189
60	MCL462	198
80	MCL482	219
100	MCL402	240



Para alturas superiores a 72cm elegir módulos sin tapa ni zócalo (sin añadir tacos) páginas 215-216 catálogo VITA

40/50/60/80/100

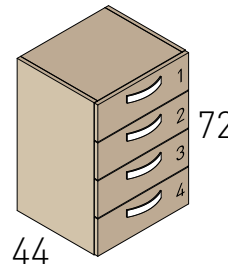

largo	referencia	puntos
40	MCL444	240
50	MCL454	249
60	MCL464	261
80	MCL484	303
100	MCL404	351

Izquierda 40/50/60

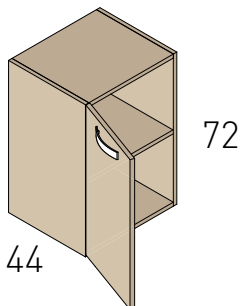

largo	referencia	puntos
40	MCL44Z	127
50	MCL45Z	135
60	MCL46Z	143

Derecha 40/50/60

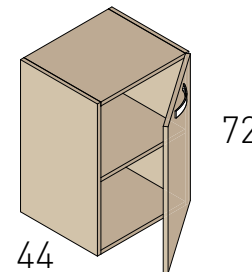

largo	referencia	puntos
40	MCL44D	127
50	MCL45D	135
60	MCL46D	143

80/100

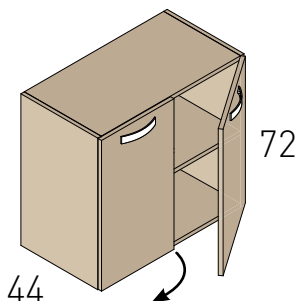

largo	referencia	puntos
80	MCL48P	176
100	MCL40P	187

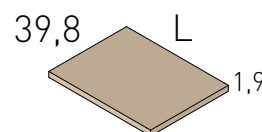

Estante interior para módulos

largo	referencia	puntos
36,1	EMD36	24
46,1	EMD46	26
56,1	EMD56	29
76,1	EMD76	32
96,1	EMD96	36

Para frentes acabado Stone añadir 8 puntos/m2, con un mínimo de 2 puntos por pieza

Tapa o base grueso 1cm

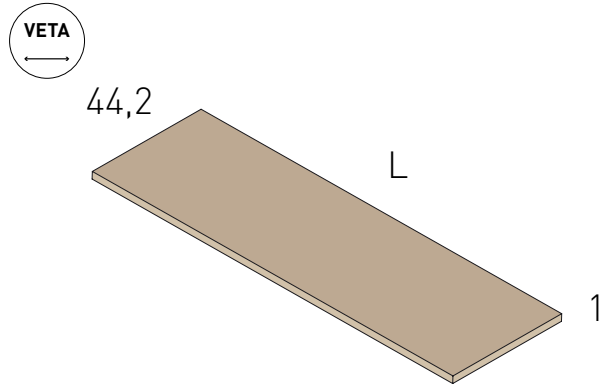

Forro a costado grueso 1cm

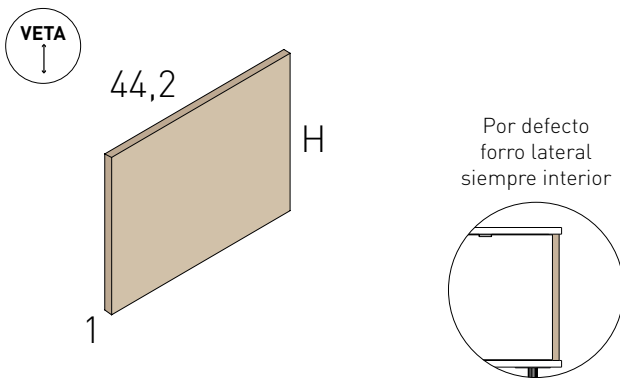

Tapa o base grueso 1,9cm

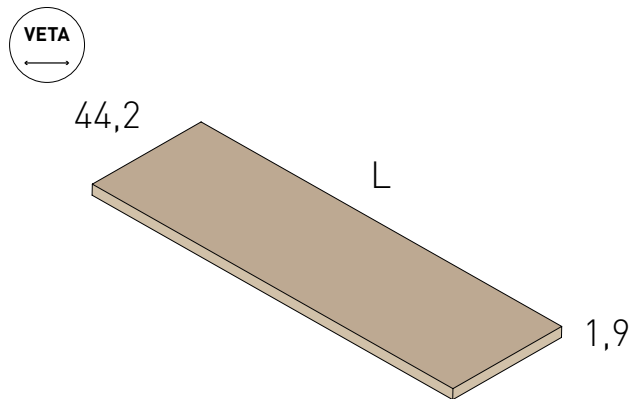

Forro a costado grueso 1,9cm

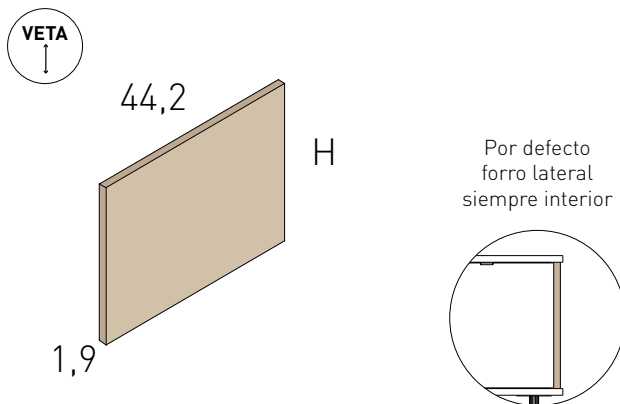

L	Acabado BASE		Acabado STONE	
	referencia	puntos	referencia	puntos
40	T4104	18	TS4104	20
60	T4106	19	TS4106	21
80	T4108	20	TS4108	22
100	T4110	23	TS4110	26
120	T4112	28	TS4112	31
140	T4114	32	TS4114	35
160	T4116	37	TS4116	41
180	T4118	42	TS4118	46
200	T4120	46	TS4120	51
250	T4125	57	TS4125	64
282	T4128	65	TS4128	72
H				
18	CM4118	12	CS4118	14
36	CM4136	18	CS4136	20
54	CM4154	19	CS4154	21
72	CM4172	20	CS4172	22
L				
40	T4204	20	TS4204	22
60	T4206	23	TS4206	25
80	T4208	24	TS4208	27
100	T4210	29	TS4210	33
120	T4212	34	TS4212	38
140	T4214	39	TS4214	44
160	T4216	45	TS4216	50
180	T4218	51	TS4218	57
200	T4220	58	TS4220	65
250	T4225	73	TS4225	82
282	T4228	82	TS4228	92
H				
18	CM4218	15	CS4218	17
36	CM4236	20	CS4236	22
54	CM4254	23	CS4254	25
72	CM4272	24	CS4272	27

Ruedas para módulos

MODELO BÁSICO
Con frenos sobre pedido

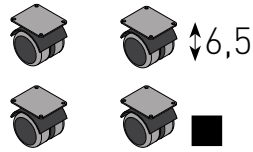

cant.	ref.	puntos
4	R814	22
1	R811	6

FORMULA BLANCO
Pack 4: 2 con freno

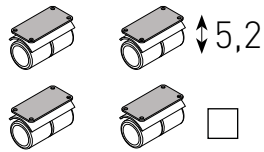

cant.	ref.	puntos
4	RB84	35
1	RB81	9

Patas para módulos

CUADRADA

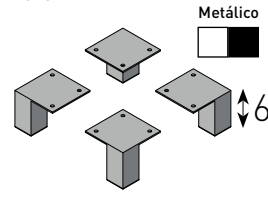

cant.	ref.	puntos
4	P460	64
1	P461	16

TUB

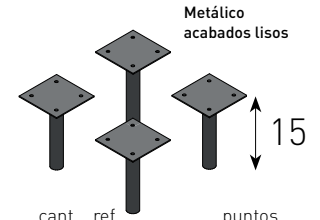

cant.	ref.	puntos
4	TUB4	72
1	TUB1	18

DISEÑO PLUS

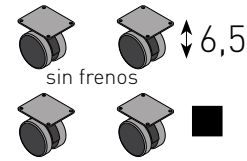

cant.	ref.	puntos
4	RP4	28
1	RP1	7

OSLO

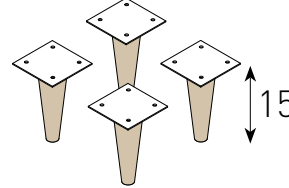

cant.	ref.	puntos	puntos
4	PSL4	96	136
1	PSL1	24	34

TUB CON REGULADOR

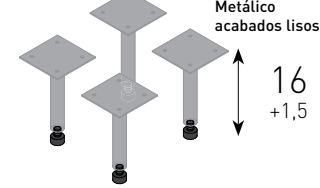

cant.	ref.	puntos
4	TBR4	88
1	TBR1	22

Ejemplos libre configuración

Tapa, base y sin forros

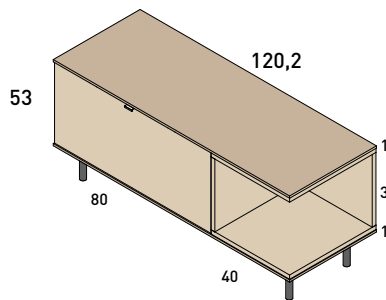

ud	referencia	puntos	total
1	MCL28A	144	144
1	CNS44	58	58
2	T4112	28	56
1	TUB4	72	72
total puntos			330

Tapa, base y forros de 1cm

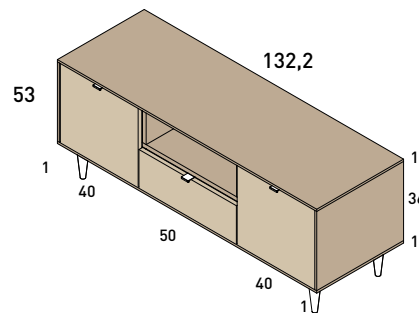

ud	referencia	puntos	total
1	MCL24Z	106	106
1	MCL151	113	113
1	MCL150	62	62
1	MCL24D	122	122
2	T4114	32	64
2	CM4136	18	36
1	TUB4	72	72
total puntos			575

Tapa, base y forros de 1,9cm

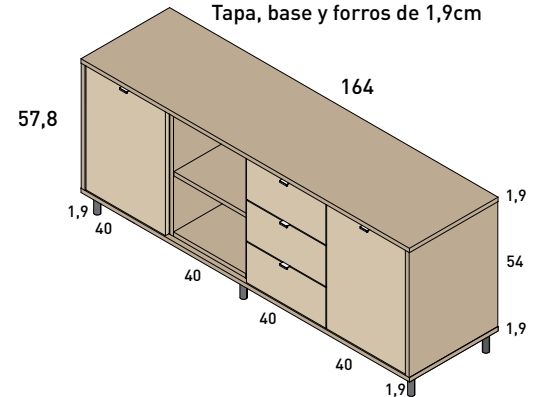

ud	referencia	puntos	total
1	MCL34Z	119	119
1	MCL340	95	95
1	MCL343	196	196
1	MCL34D	119	119
2	T4218	51	102
2	CM4254	23	46
5	TUB1	18	90
total puntos			767

LED CON BATERÍA

Led con batería

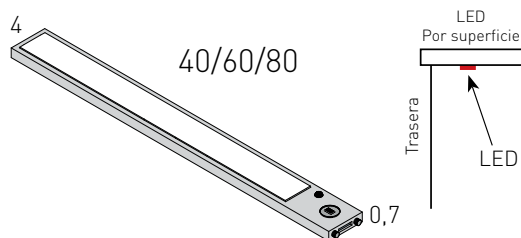

L	Ref.	Puntos
40	LB40	48
60	LB60	65
80	LB80	85

Sistema con batería recargable USB, configuración activación sensor de movimiento, control de color e intensidad, sin mecanizar, se instala en superficie

SUSTITUCIÓN DE GUÍAS CAJÓN

Incremento por sustitución por cada cajón de guías de extracción parcial a:

guías	puntos/cajón
Extracción total	+8
Push extracción parcial	+6
Push extracción total	+8

Sustitución de guías de extracción total a:

guías	puntos/cajón
Push extracción total	sin/inc



TOTAL

Se extrae la totalidad de cajón menos 2 cm aprox.



PARCIAL

14 cm del cajón siempre quedan ocultos.

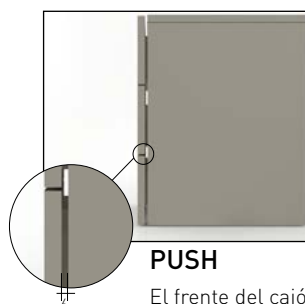

PUSH

El frente del cajón sobresale 6 mm de la estructura del mueble



Con guía PUSH 6 mm adicionales se deben considerar al combinar con otros artículos



- Se recomienda incluir forros laterales y superiores
- Añadir 8 mm extras de fondo a sobres y costados

CERRADURA

Puertas y frentes cajón

	puntos/und
Cerradura	+30



Solo admite cerradura puerta LISA



1

Descripción	Ud.	Ref	Puntos	Total
Estructura armario batiente 300 largo 239 alto	1	ARB304	720	720
Puerta DR Toca-Toca	3	PJA4D	68	204
Puerta IZ Toca-Toca	3	PJA4Z	68	204
Estante	9	ET60	34	306
Barra colgar	1	BC10	28	28
Cajón Interior costilla 22	2	CGN150	77	154
Cajón interior costilla 11	4	CGN110	62	248
Cajonera tapa + costados	2	CFN180	50	100
Toca-Toca de superficie	6	TOCASUP	8	48
Estructura armario batiente 50 largo 239 alto	1	ARB54Z	187	187
Cajón exterior costilla 22	1	CGE56	65	65
Estante superior cajones	1	CFE46	37	37
Barra colgar	1	BC5	19	19
Estante	2	ET66	29	58
Puerta DR Toca-Toca corta	1	PJA4Z	27	27
Toca-Toca de superficie	1	TOCASUP	8	8
TOTAL COMPOSICIÓN 1				2413



2

Descripción	Ud.	Ref	Puntos	Total
Estructura armario batiente 300 largo 239 alto	1	ARB304	720	720
Puerta DR CRAFT	3	PJG4D	148	444
Puerta IZ CRAFT	3	PJG4Z	148	444
Estante	7	ET60	34	238
Barra colgar	3	BC10	28	84
ZONA CAMA				
Canape 190x150 apertura frontal	1	CEF/10	614	614
Arrimadero grueso 5cm con LED y rebaje zócalo	1	AM5L-Z	303	303
Arrimadero grueso 3cm con rebaje zócalo	1	AM3-Z	50	50
Módulo 2 cajones con tapa - Tirador Gola (VITA)	1	MT262	185	185
TOTAL COMPOSICIÓN 2				3082



3

Descripción	Ud.	Ref	Puntos	Total
Estructura armario batiente 300 largo 239 alto	1	ARB304	720	720
Puerta DR CRAFT	3	PJG4D	148	444
Puerta IZ CRAFT	3	PJG4Z	148	444
Estante	5	ET60	34	170
Barra colgar	3	BC10	28	84
Cajonera 2 cajones colgar costilla 11	1	CG210C	174	174
ZONA CAMA				
Canape 190x150 apertura frontal	1	CEF/10	614	614
Arrimadero RÚSTICO	1	CTB3	106	106
Arrimadero RÚSTICO	1	CTB3	53	53
Módulo 2 cajones con tapa - Tirador Gola (VITA)	1	MT262	182	185
Mesa Shitake L	1	TB50	102	102
Mesa Shitake M	1	TB40	92	92
TOTAL COMPOSICIÓN 3				3188

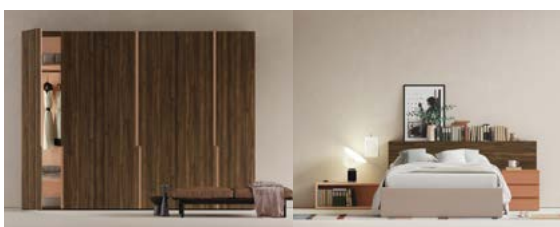

4

Descripción	Ud.	Ref	Puntos	Total
Estructura armario batiente 300 largo 239 alto	1	ARB304	720	720
Puerta DR CRAFT	3	PJG4D	148	444
Puerta IZ CRAFT	3	PJG4Z	148	444
Estante	6	ET60	34	204
Barra colgar	3	BC10	28	84
ZONA CAMA				
Canape 190x150 apertura frontal	1	CEF/10T	884	884
Arrimadero WALL	1	CLV	193	193
Tapa WALL	1	CLT	53	53
Módulo 3 cajones con tapa - Tirador Gola (VITA)	1	MT353	203	203
Módulo diafano	1	C310	100	100
TOTAL COMPOSICIÓN 4				3329



BLANCO

5

Descripción	Ud.	Ref	Puntos	Total
Estructura armario batiente 400 largo 239 alto	1	ARB404	960	960
Puerta DR VERTICAL	4	PJJ4D	83	332
Puerta IZ VERTICAL	4	PJJ4Z	83	332
Estante	8	ET60	34	272
Barra colgar	4	BC10	28	112
TOTAL COMPOSICIÓN 5				2008



OXID
COBRE

6

Descripción	Ud.	Ref	Puntos	Total
Estructura armario batiente 300 largo 239 alto	1	ARB304	720	720
Puerta DR VERTICAL Stone	3	PSJ4D	90	270
Puerta IZ LISA Stone	3	PSA4Z	75	225
Estante	6	ET60	34	204
Barra colgar	3	BC10	28	84
TOTAL COMPOSICIÓN 6				1503



TORTORA
FOREST

7

Descripción	Ud.	Ref	Puntos	Total
Estructura armario batiente 300 largo 239 alto	1	ARB304	720	720
Puerta DR VERTICAL	3	PJJ4D	83	249
Puerta IZ LISA	3	PJA4Z	68	204
Estante	6	ET60	34	204
Barra colgar	3	BC10	28	84
TOTAL COMPOSICIÓN 7				1461



ARENA
TORTORA

8

Descripción	Ud.	Ref	Puntos	Total
Estructura armario batiente 300 largo 239 alto	1	ARB304	720	720
Puerta DR IRIS	3	PJH4D	106	318
Puerta IZ IRIS	3	PJH4Z	106	318
Estante	6	ET60	34	204
Barra colgar	3	BC10	28	84
TOTAL COMPOSICIÓN 8				1644



TERRACOTA
VALENTINA

9

Descripción	Ud.	Ref	Puntos	Total
Estructura armario batiente 300 largo 239 alto	1	ARB304	720	720
Puerta DR IRIS	3	PJA4D	68	204
Puerta IZ IRIS	3	PJH4Z	106	318
Estante	6	ET60	34	204
Barra colgar	3	BC10	28	84
TOTAL COMPOSICIÓN 9				1530



BLANCO
TERRACOTA

10

Descripción	Ud.	Ref	Puntos	Total
Estructura armario batiente 400 largo 239 alto	1	ARB404	960	960
Puerta DR MATRI	4	PJE4D	108	432
Puerta IZ LISA	4	PJA4Z	68	272
Estante	8	ET60	34	272
Barra colgar	4	BC10	28	112
TOTAL COMPOSICIÓN 02				2048



TERRACOTA
ARENA

11

Descripción	Ud.	Ref	Puntos	Total
Estructura armario batiente 400 largo 239 alto	1	ARB404	960	960
Puerta DR LISA	3	PJA4D	68	204
Puerta IZ MATRI	3	PJE4Z	108	324
Puerta IZ MATRI	1	PJE4Z	108	108
Estante	6	ET60	34	204
Barra colgar	3	BC10	28	84
Partidor	1	DNT15	54	54
Estante	6	ET65	25	150
Estante superior cajones	1	CFE80	50	50
Cajón exterior 18 cm costilla 11	2	CGE10	62	124
Cajón exterior 30 cm costilla 22	1	CGE60	65	65
Forro lateral armario	2	FR401	54	108
TOTAL COMPOSICIÓN 11				2435

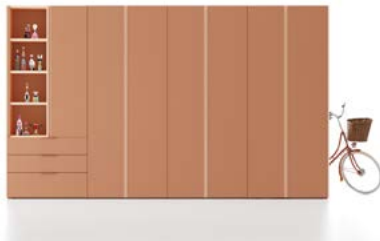

TERRACOTA
NUPE

12

Descripción	Ud.	Ref	Puntos	Total
Estructura armario batiente 400 largo 239 alto	1	ARB404	960	960
Puerta DRLISA	3	PJA4D	68	204
Puerta IZ MATRI	3	PJE4Z	108	324
Puerta DR MATRI	1	PJE4D	108	108
Estante	6	ET60	34	204
Barra colgar	3	BC10	28	84
Partidor	1	DNT15	54	54
Estante	6	ET65	25	150
Estante superior cajones	1	CFE80	50	50
Cajón Exterior 18 cm (costilla 11)	2	CGE10	62	124
Cajón Exterior 30 cm (costilla 22)	1	CGE60	65	65
Forro lateral armario	2	FR401	54	108
TOTAL COMPOSICIÓN 12				2435



BLANCO
FOREST

13

Descripción	Ud.	Ref	Puntos	Total
Estructura armario batiente 400 largo 239 alto	1	ARB404	960	960
Puerta IZ RELIEF 20 cm	1	PJL4Z	112	112
Puerta DR RELIEF 20 cm	2	PJL4D	112	224
Puerta IZ RELIEF 10 cm	3	PJK4Z	102	306
Puerta DR RELIEF 10 cm	2	PJK4D	102	204
Barra colgar	3	BC10	28	84
Estante	8	ET60	34	272
TOTAL COMPOSICIÓN 13				2162



BLANCO
KHAKE

14

Descripción	Ud.	Ref	Puntos	Total
Estructura armario batiente 400 largo 239 alto	1	ARB404	960	960
Puerta IZ RELIEF 20 cm	1	PJL4Z	112	112
Puerta DR RELIEF 20 cm	2	PJL4D	112	224
Puerta IZ RELIEF 10 cm	3	PJK4Z	102	306
Puerta DR RELIEF 10 cm	2	PJK4D	102	204
Barra colgar	3	BC10	28	84
Estante	10	ET60	34	340
Iluminación LED	1	LED20	288	288
TOTAL COMPOSICIÓN 14				2518



FOREST
TORTORA

15

Descripción	Ud.	Ref	Puntos	Total
Estructura armario batiente 250 largo 239 alto	1	ARB254	640	640
Puerta DR RÚSTICA	2	PJB4D	88	176
Puerta IZ RÚSTICA con Testa Total	3	PJB4Z	108	324
Estante	2	ET60	34	68
Estante	2	ET65	25	50
Estante Extraíble	2	ETT60	66	132
Estante Zapatero extraíble	3	EX101	75	225
Estante Zapatero fijo	1	EZ101	50	50
Estante Zapatero inclinado	3	EN101	56	168
Barra colgar	1	BC5	19	19
Pantalonero	1	PNT101	172	172
Armario rincón 100 largo 100 fondo 239 alto	1	AR4	440	440
Puerta DR RÚSTICA	1	PJB4D	88	88
Puerta IZ RÚSTICA con Testa Total	1	PJB4Z	108	108
Estante rincón	3	ETR8	96	288
Barra de colgar rincón	1	BN50	50	50
Estructura armario batiente 200 largo 239 alto	1	ARB204	494	494
Puerta DR RÚSTICA	2	PJB4D	88	176
Puerta IZ RÚSTICA con Testa Total	2	PJB4Z	108	216
Estante	2	ET60	34	68
Casillero	2	CS10	114	228
Cajonera Libre Configuración	1	CFN180	50	50
Cajón Libre Configuración costilla 11	1	CGN110	62	62
Cajón separador	1	CRB103	34	34
Cajón Libre Configuración costilla 16	2	CGN160	65	130
Cajón Libre Configuración costilla 22	1	CGN150	77	77
Cajonera Libre Configuración	1	CFN180	50	50
Cajón Libre Configuración costilla 11	1	CGN110	62	62
Cajón Libre Configuración costilla 16	1	CGN160	65	65
Estante Zapatero extraíble	1	EX101	75	75
TOTAL COMPOSICIÓN 15				4785



VALENTINA
MOSTAZA

16

Descripción	Ud.	Ref	Puntos	Total
Estructura armario batiente 300 largo 239 alto	1	ARB304	720	720
Puerta DR RÚSTICA	3	PJB4D	88	264
Puerta IZ RÚSTICA con Testa Total	3	PJB4Z	108	324
Estante	6	ET60	34	204
Barra colgar	2	BC10	28	56
Cajonera 2 cajones colgar costilla 11	2	CG210C	174	348
Pantalonero	1	PNT101	172	172
TOTAL COMPOSICIÓN 16				2088



HUMO
VULCANO

17

Descripción	Ud.	Ref	Puntos	Total
Estructura armario batiente 400 largo 239 alto	1	ARB404	960	960
Puerta DR RÚSTICA	4	PJB4D	88	352
Puerta IZ RÚSTICA con Testa Total	4	PJB4Z	108	432
Estante	8	ET60	34	272
Barra colgar	4	BC10	28	112
Cajonera 2 cajones colgar costilla 11	1	CG210C	174	174
ZONA CAMA				
Canape 190x150 apertura frontal	1	CEF/10	614	614
Arrimadero grueso 3	1	AM3	48	48
Arrimadero RÚSTICO grueso 3 (Especial)	1	CTB3	276	276
Módulo con tapa sin zócalo 2 cajones - Tirador Gola	1	MT252	158	143
Mesa Shitake L	1	TB50	102	102
Mesa Shitake M	1	TB40	92	92
TOTAL COMPOSICIÓN 17				3577



18

Descripción	Ud.	Ref	Puntos	Total
Estructura armario batiente 300 largo 239 alto	1	ARB304	720	720
Puerta DR NEO	3	PJD4D	76	228
Puerta IZ NEO	3	PJD4Z	76	228
Estante	5	ET60	34	170
Barra colgar	3	BC10	28	84
Cajonera 2 cajones costilla 11	1	CG2110	174	174
Cajonera 1 cajón colgar costilla 11	1	CG110C	112	112
TOTAL COMPOSICIÓN 18				1716



19



20

Descripción	Ud.	Ref	Puntos	Total
Estructura armario batiente 250 largo 239 alto	1	ARB254	640	640
Puerta DR NEO	3	PJD4D	76	228
Puerta IZ NEO	2	PJD4Z	76	152
Estante	4	ET60	34	136
Barra colgar	2	BC10	28	56
Estante	2	ET65	25	50
Barra colgar	1	BC5	19	19
TOTAL COMPOSICIÓN 19 y 20				1281



21 PTAS BATIENTES

Descripción	Ud.	Ref	Puntos	Total
Estructura armario batiente 400 largo 239 alto	1	ARB404	960	960
Puerta DR SEMI	4	PJF4D	76	304
Puerta IZ SEMI	4	PJF4Z	72	288
Estante	9	ET60	34	306
Estante	6	ET65	25	150
Barra colgar	2	BC10	28	56
Barra colgar	2	BC5	19	38
Partidor	2	DNT20	58	116
Cajonera 3 cajones costilla 11	2	CG3116	187	374
TOTAL COMPOSICIÓN 21 CON PUERTAS BATIENTES				2592



21 PTAS PLEGABLES

Descripción	Ud.	Ref	Puntos	Total
Estructura armario plegable 4000 largo 239 alto	1	ARP404	1000	1000
Puerta IZ Pleg. A LISA Esp. Tirador SEMI Corto	2	PGA404	106	212
Puerta IZ Pleg. B LISA Esp. Tirador SEMI largo	2	PGB404	106	212
Puerta DR Pleg. C LISA Esp. Tirador SEMI Corto	2	PGC404	102	204
Puerta DR Pleg. D LISA Esp. Tirador SEMI largo	2	PGD404	110	220
Estante	10	ET80	34	340
Estante	6	ET85	25	150
Barra colgar	2	BC10	28	56
Barra colgar	2	BC5	19	38
Partidor	2	DNT203	58	116
Cajonera 3 cajones costilla 11	2	CG3116	187	374
TOTAL COMPOSICIÓN 21 CON PUERTAS PLEGABLES				2922



22 PTAS BATIENTES

Descripción	Ud.	Ref	Puntos	Total
Estructura armario batiente 400 largo 239 alto	1	ARB404	960	960
Puerta DR Enmarcada LUX Cristal	4	PVQ4D	330	1320
Puerta IZ Enmarcada LUX Cristal	4	PVQ4Z	330	1320
Estante	10	ET60	34	340
Estante	6	ET65	25	150
Barra colgar	2	BC10	28	56
Barra colgar	2	BC5	19	38
Partidor	2	DNT20	58	116
Cajonera 3 cajones costilla 11	2	CG3116	187	374
TOTAL COMPOSICIÓN 22 CON PUERTAS BATIENTES				4674



22 PTAS PLEGABLES

Descripción	Ud.	Ref	Puntos	Total
Estructura armario plegable 400 largo 239 alto	1	ARP404	1000	1000
Puerta IZ Pleg. A LUX Cristal	2	PVA514	364	728
Puerta IZ Pleg. B LUX Cristal	2	PVB514	360	720
Puerta DR Pleg. C LUX Cristal	2	PVC514	360	720
Puerta DR Pleg. D LUX Cristal	2	PVD514	364	728
Estante	10	ET80	34	340
Estante	6	ET85	25	150
Barra colgar	2	BC10	28	56
Barra colgar	2	BC5	19	38
Partidor	2	DNT203	58	116
Cajonera 3 cajones costilla 11	2	CG3116	187	374
TOTAL COMPOSICIÓN 22 CON PUERTAS PLEGABLES				4970



23

Descripción	Ud.	Ref	Puntos	Total
Estructura armario batiente 300 largo 239 alto	1	ARB304	720	720
Puerta DR Enmarcada 1 Plafón Stone	3	PSM4D	137	411
Puerta IZ Enmarcada 1 Plafón Stone	3	PMS4Z	137	411
Toca Toca de superficie	6	TOCASUP	8	48
Estante	6	ET60	34	204
Barra colgar	3	BC10	28	84
Cajonera 3 cajones costilla 11	1	CG3116	187	187
Partidor	1	DNT20	58	58
TOTAL COMPOSICIÓN 23				2123



24

Descripción	Ud.	Ref	Puntos	Total
Estructura armario batiente 300 largo 239 alto	1	ARB304	720	720
Puerta DR Enmarcada 3 Plafones	3	PJN4D	133	399
Puerta IZ Enmarcada 3 Plafones	3	PJN4Z	133	399
Toca Toca de superficie	6	TOCASUP	8	48
Estante	6	ET60	34	204
Barra colgar	3	BC10	28	84
TOTAL COMPOSICIÓN 24				1854



IVORY
ARENA
KHAKE

25

Descripción	Ud.	Ref	Puntos	Total
Estructura armario batiente 300 largo 239 alto	1	ARB304	720	720
Puerta DR Enmarcada 3 Plafones	2	PJN4D	133	266
Puerta IZ Enmarcada 3 Plafones	2	PJN4Z	133	266
Puerta DR Enmarcada 3 Plafones Combinables	1	PJV4D	160	160
Puerta IZ Enmarcada 3 Plafones Combinables	1	PJV4Z	160	160
Toca Toca de superficie	6	TOCASUP	8	48
Estante	6	ET60	34	204
Barra colgar	3	BC10	28	84
TOTAL COMPOSICIÓN 25				1908



ARENA
IVORY
NUUDE
NORDICO

26

Descripción	Ud.	Ref	Puntos	Total
Estructura armario batiente 300 largo 239 alto	1	ARB304	720	720
Puerta DR DESIGUAL	3	PJP4D	140	420
Puerta IZ LISA	3	PJA4Z	68	204
Estante	9	ET60	34	306
Barra colgar	2	BC10	28	56
Cajonera 3 cajones costilla 11	3	CG3110	236	708
TOTAL COMPOSICIÓN 26				2414

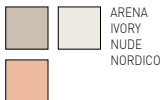

ARENA
IVORY
NUUDE
NORDICO

27

Descripción	Ud.	Ref	Puntos	Total
Estructura armario batiente 300 largo 239 alto	1	ARB304	720	720
Puerta DR Desigual	3	PJP4D	140	420
Puerta IZ LISA	3	PJA4Z	68	204
Estante	8	ET60	34	272
Barra colgar	2	BC10	28	56
Cajonera 3 cajones costilla 11	2	CG3110	236	472
Pantalonero	1	PNT101	172	172
TOTAL COMPOSICIÓN 27				2316



BLANCO
HUMO
CRISTAL FUME
NORDICO

28

Descripción	Ud.	Ref	Puntos	Total
Estructura armario batiente 150 largo 239 alto	1	ARB154	384	384
Puerta DR Enmarcada LUX Cristal	2	PVQ4D	330	660
Puerta IZ Enmarcada LUX Cristal	1	PVQ4Z	330	330
Estante	2	ET60	34	68
Estante	5	ET65	25	125
Barra de colgar	1	BC10	28	28
Armario Rincón 100 largo 100 fondo 239 alto	1	AR4	440	440
Puerta DR Enmarcada LUX Cristal	1	PVQ4D	330	330
Puerta IZ Enmarcada LUX Cristal	1	PVQ4Z	330	330
Estante rincón	2	ETR8	96	192
Barra de colgar	1	BN	50	50
Estructura armario batiente 100 largo 239 alto	1	ARB104	261	261
Puerta DR Enmarcada LUX Cristal	1	PVQ4D	330	330
Puerta IZ Enmarcada LUX Cristal	1	PVQ4Z	330	330
Estante	2	ET60	34	68
Barra de colgar	1	BC10	28	28
ZONA CAMA				
Cubo para Tatami	4	TC2	203	812
Arcón 2 carros	1	A2C	412	412
TOTAL COMPOSICIÓN 28				5178



29

Descripción	Ud.	Ref	Puntos	Total
Estructura armario batiente 300 largo alto 239	1	ARB304	720	720
Puerta DR Enmarcada LUX Cristal	2	PVQ4D	330	660
Puerta IZ Enmarcada LUX Cristal	2	PVQ4Z	330	660
Puerta DR Enmarcada LUX Stone	1	PSQ4D	207	207
Puerta IZ Enmarcada LUX Stone	1	PSQ4Z	207	207
Estante	5	ET60	34	170
Iluminacion LED	3	LED20	288	864
Estructura base (Serie+)	7	EBC4	160	1120
Cajón organizador (Serie+)	2	CML7	148	296
Cajón extraíble (Serie+)	2	CR457	70	140
Zapatero extraíble (Serie+)	1	ZR457	60	60
Zapatero lateral extraíble IZ (Serie+)	1	ZPR1	201	201
Zapatero lateral extraíble DR (Serie+)	1	ZPR2	201	201
Colgador extraíble (Serie+)	2	CE45	74	148
Corbatero extraíble (Serie+)	1	CBT45	74	74
Barra de colgar (Serie+)	1	BRN1	30	30
Barra de colgar abatible (Serie+)	1	BAT	110	110
Barra pantalonero (Serie+)	6	TA	6	36

ZONA CAMA

Cubo tapa elevable para componer tatamis	4	T21/S	146	584
Cabezal SET Tapizado	1	C49T	375	375
Arrimadero grueso 1,9 acabado Stone	2	AMS	44	88
Módulo con tapa sin zócalo 2 cajones [VITA]	2	MT262	151	302

TOTAL COMPOSICIÓN 29

7253



30

Descripción	Ud.	Ref	Puntos	Total
Estructura armario batiente 300 largo alto 239	1	ARB304	720	720
Puerta DR Enmarcada 1 Plafón	2	PJM4D	130	260
Puerta DR Enmarcada 1 Plafón Stone	1	PSM4D	137	137
Puerta IZ Enmarcada 1 Plafón Stone	3	PSM4Z	137	411
Estante	6	ET60	34	204
Barra de colgar	3	BC10	28	84

TOTAL COMPOSICIÓN 30

1816



31

Descripción	Ud.	Ref	Puntos	Total
Estructura armario batiente 100 largo 239 alto	1	ARB104	261	261
Puerta DR LISA	1	PJA4D	68	68
Puerta IZ LISA	1	PJA4Z	68	68
Estante	2	ET60	34	68
Barra de colgar	1	BC10	28	28
Estructura armario batiente 100 largo 239 alto	1	ARB104	261	261
Puerta DR Enmarcada AIR Cristal	1	PVR4D	378	378
Puerta IZ Enmarcada AIR Cristal	1	PVR4Z	378	378
Estante	2	ET60	34	68
Barra de colgar	1	BC10	28	28
Estructura base (Serie+)	1	EBC4	160	160
Cajón organizador (Serie+)	1	CML7	148	148
Armario rincón 100 largo 100 fondo 239 alto	1	AR4	440	440
Puerta DR LISA	1	PJA4D	68	68
Puerta IZ LISA	1	PJA4Z	68	68
Estante rincón	2	ETR8	96	192
Barra de colgar rincón	1	BN	50	50
Estructura armario batiente 200 largo 239 alto	1	ARB204	494	494
Puerta DR Enmarcada LUX Cristal	1	PVQ4D	330	330
Puerta IZ Enmarcada LUX Cristal	1	PVQ4Z	330	330
Estante	2	ET60	34	68
Barra de colgar	1	BC10	28	28
Estructura armario batiente 200 largo alto 239	1	ARB204	494	494
Puerta DR Enmarcada LUX Cristal	1	PVQ4D	330	330
Puerta IZ Enmarcada LUX Cristal	1	PVQ4Z	330	330
Estante	1	ET60	34	34
Barra de colgar	1	BC10	28	28
Estructura base (Serie+)	2	EBC4	160	320
Barra pantalonero (Serie+)	12	TA	6	72

ZONA CAMA

Cama GOAT 190x150	1	GOAT/10	377	377
Cabezal DUE tapizado	2	DULET	273	546
Cabezal DUE tapizado	1	DULET	501	501
Módulo con tapa sin zócalo 2 cajones (VITA)	2	MT262	151	302

TOTAL COMPOSICIÓN 31

7316



32

Descripción	Ud.	Ref	Puntos	Total
Arcón para componer tatamis tapa elevable	4	T21/S	146	584
Cabezal DUE tapizado	1	DUET	375	375
Arrimadero grueso 1,9cm enmarcado	2	AMS	82	164
Módulo con tapa sin zócalo 3 cajones (VITA)	2	MT353	179	358

TOTAL COMPOSICIÓN 32

1481



33

Descripción	Ud.	Ref	Puntos	Total
Arcón para componer tatamis tapa elevable	4	T21/S	146	584
Cabezal DUE tapizado	1	DUET	375	375
Arrimadero grueso 1,9cm enmarcado	2	AMC	80	160
Módulo con tapa sin zócalo 3 cajones (VITA)	2	MT353	179	358

TOTAL COMPOSICIÓN 33

1477



VULCANO
CRISTAL NETO

34

Descripción	Ud.	Ref	Puntos	Total
PARTE A DERECHA				
Estructura armario batiente 100 largo 239 alto	1	ARB104	261	261
Puerta DR Enmarcada AIR Cristal	1	PVR4D	378	378
Puerta IZ Enmarcada AIR Cristal	1	PVR4Z	378	378
Rail System	1	RAIL	110	110
Iluminación LED	1	LED20	288	288
Estante Rail System	1	ET60R	48	48
Barra de colgar Rail System	1	BC10R	30	30
Pantalonero Rail System	1	PNT101R	196	196
Estructura armario batiente 100 largo 239 alto	1	ARB104	261	261
Puerta DR Enmarcada AIR Cristal	1	PVR4D	378	378
Puerta IZ Enmarcada AIR Cristal	1	PVR4Z	378	378
Rail System	1	RAIL	110	110
Iluminación LED	1	LED20	288	288
Estante Rail System	1	ET60R	48	48
Casillero Rail System	1	CS122R	172	172
Estante Zapatero extraíble Rail System	2	EX101R	89	178
Estructura armario batiente 100 largo 239 alto	1	ARB104	261	261
Puerta DR Enmarcada AIR Cristal	1	PVR4D	378	378
Puerta IZ Enmarcada AIR Cristal	1	PVR4Z	378	378
Rail System	1	RAIL	110	110
Iluminación LED	1	LED20	288	288
Columna metálica interior	1	CAL30	96	96
Estante columna metálica Rail System	8	ET65R	39	312
Barra de colgar Rail System	1	BC5R	21	21
PARTE B IZQUIERDA				
Estructura armario batiente 100 largo 239 alto	1	ARB104	261	261
Puerta DR Enmarcada AIR Cristal	1	PVR4D	378	378
Puerta IZ Enmarcada AIR Cristal	1	PVR4Z	378	378
Rail System	1	RAIL	110	110
Iluminación LED	1	LED20	288	288
Columna metálica interior	1	CAL30	96	96
Estante columna metálica Rail System	8	ET65R	39	312
Barra de colgar Rail System	2	BC5R	21	42
Estructura armario batiente 100 largo 239 alto	1	ARB104	261	261
Puerta DR Enmarcada AIR Cristal	1	PVR4D	378	378
Puerta IZ Enmarcada AIR Cristal	1	PVR4Z	378	378
Rail System	1	RAIL	110	110
Iluminación LED	1	LED20	288	288
Estante Rail System	2	ET60R	48	96
Cajonera 2 cajones costilla 16	1	CG2160R	237	237
Estante zapatero extraíble Rail System	2	EX101R	89	178
Estructura armario batiente 100 largo 239 alto	1	ARB104	261	261
Puerta DR Enmarcada AIR Cristal	1	PVR4D	378	378
Puerta IZ Enmarcada AIR Cristal	1	PVR4Z	378	378
Rail System	1	RAIL	110	110
Iluminación LED	1	LED20	288	288
Estante Rail System	1	ET60R	48	48
Barra de colgar Rail System	1	BC10R	30	30
Cajonera Libre Configuración	1	CFN180R	97	97
Cajón Libre Configuración costilla 11	1	CGN110	62	62
Cajón Libre Configuración costilla 16	4	CGN160	65	260
TOTAL COMPOSICIÓN 34			11049	

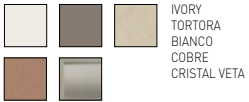

35

Descripción	Ud.	Ref	Puntos	Total
Estructura armario corredero exterior 300 largo 239 alto	1	APC304	822	822
Puerta IZ Corredera LUX 1 Plafon Stone	1	PTA404	680	680
Puerta CEN Corredera LUX 1 Plafon Cristal	1	PVB404	880	880
Puerta DR Corredera LUX 1 Plafon Stone	1	PTC404	680	680
Estante armario	2	ET80	34	68
Barra colgar armario	1	BC10	28	28
Columna metálica armario	2	CAL2	96	192
Estante columna metálica	4	ET94	37	148
Estante columna metálica	4	ET96	44	176
Barra colgar armario	1	BC45	27	27
Barra colgar armario	1	BC56	30	30
Estante cristal armario	3	EV44	66	198
Estante cristal armario	5	EV64	82	410
Estante extraíble Rail System	1	EZ44Z	49	49
Estante extraíble Rail System	1	EZ44D	49	49
Estante extraíble Rail System	1	EZ64Z	57	57
Estante extraíble Rail System	1	EZ64D	57	57
Cajonera columna metálica	1	CG263	166	166
Iluminación armario	3	LED20	288	864
TOTAL COMPOSICIÓN 35				5581



36

Descripción	Ud.	Ref	Puntos	Total
Estructura armario corredero exterior 300 largo 239 alto	1	APC304	822	822
Puerta IZ corredera LUX 1 Plafón	1	PCA404	660	660
Puerta CEN corredera LUX 1 Plafón Cristal	1	PVA404	880	880
Puerta DR corredera LUX 1 Plafón	1	PCC404	660	660
Estante armario	7	ET80	34	238
Barra colgar armario	3	BC10	28	84
TOTAL COMPOSICIÓN 36				3344



37

Descripción	Ud.	Ref	Puntos	Total
Cabezal tapizado SET	1	C49T	412	412
Arrimadero 30 mm	1	AM3	64	64
Cama GOA 190x150	1	GOAT/10	377	377
Módulo con tapa sin zócalo 2 cajones (VITA)	1	MT282	174	174
Mesita Shitake L	1	TB50	102	102
TOTAL COMPOSICIÓN 37				1129



38

Descripción	Ud.	Ref	Puntos	Total
Estructura armario corredero exterior 300 largo 239 alto	1	APC304	822	822
Puerta IZ corredera LUX 1 Plafón Stone	1	PTA404	680	680
Puerta CEN corredera LUX 1 Plafón Stone	1	PTB404	680	680
Puerta DR corredera LUX 1 Plafón Stone	1	PTC404	680	680
Estante armario	7	ET80	34	238
Barra colgar armario	3	BC10	28	84
TOTAL COMPOSICIÓN 38				3184



39

Descripción	Ud.	Ref	Puntos	Total
Cabezal tapizado SET	1	C49T	412	412
Cabezal tapizado SET	1	C49T	200	200
Cama GOA 190x150	1	GOAT/10	377	377
Módulo con tapa sin zócalo 2 cajones (VITA)	1	MT282	174	174
Mesita Shitake L	1	TB50	102	102
Mesa estudio colgada (VITA)	1	MC15	123	123
Arrimadero 30 mm	1	AM3	86	86
TOTAL COMPOSICIÓN 39				1474



40

Descripción	Ud.	Ref	Puntos	Total
Estructura armario corredero exterior 300 largo 239 alto	1	APC304	822	822
Puerta IZ corredera LUX 1 Plafón	1	PCA404	660	660
Puerta CEN corredera LUX 1 Plafón Cristal	1	PVB404	880	880
Puerta DR corredera LUX 1 Plafón	1	PCC404	660	660
Estante armario	7	ET80	34	238
Barra colgar armario	3	BC10	28	84
TOTAL COMPOSICIÓN 40				3344



41

Descripción	Ud.	Ref	Puntos	Total
Estructura Armario Corredero Exterior 300 largo 239 alto	1	APC304	822	822
Puerta IZ corredera LUX 1 Plafón Stone	1	PTA404	680	680
Puerta CEN corredera LUX 1 Plafón Cristal	1	PVB404	880	880
Puerta DR corredera LUX 1 Plafón Stone	1	PTC404	680	680
Estante armario	7	ET80	34	238
Barra colgar armario	3	BC10	28	84
TOTAL COMPOSICIÓN 41				3384

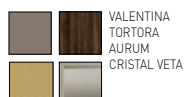

42

Descripción	Ud.	Ref	Puntos	Total
Estructura armario corredero exterior 300 largo 239 alto	1	APC304	822	822
Puerta IZ corredera LUX 1 Plafón	1	PCA404	660	660
Puerta CEN corredera LUX 1 Plafón Cristal	1	PVB404	880	880
Puerta DR corredera LUX 1 Plafón	1	PCC404	660	660
Estante armario	7	ET80	34	238
Barra colgar armario	3	BC10	28	84
TOTAL COMPOSICIÓN 42				3344



43

Descripción	Ud.	Ref	Puntos	Total
Estructura armario corredero exterior 300 largo 239 alto	1	APC304	822	822
Puerta IZ corredera LUX 1 Plafón	1	PCA404	660	660
Puerta CEN corredera LUX 1 Plafón Stone	1	PTB404	680	680
Puerta DR corredera LUX 1 Plafón	1	PCC404	660	660
Estante armario	7	RT80	34	238
Barra colgar armario	3	BC10	28	84
TOTAL COMPOSICIÓN 43				3144



44

Descripción	Ud.	Ref	Puntos	Total
Estructura armario corredero exterior 300 largo 239 alto	1	APC304	822	822
Puerta IZ corredera LUX 1 Plafón Cristal	1	PVA404	880	880
Puerta CEN corredera LUX 1 Plafón Cristal	1	PVB404	880	880
Puerta DR corredera LUX 1 Plafón Cristal	1	PVC404	880	880
Cajonera 2 cajones Rail System	1	CG2310R	234	234
Estante armario Rail System	6	ET80R	48	288
Barra colgar armario Rail System	3	BC10R	30	90
Iluminación armario	3	LED20	288	864
Rail System	3	RAIL	110	330
ZONA CAMA				
Cabezal tapizado SET 160x120	2	C49T	355	710
Cama GOA 190x150	1	GOAT/10	377	377
Módulo con tapa sin zócalo 2 cajones (VITA)	1	MT282	174	174
Mesita Shitake M	1	TB40	92	92
Mesita Shitake L	1	TB50	102	102
TOTAL COMPOSICIÓN 44				6723



45

Descripción	Ud.	Ref	Puntos	Total
Estructura armario corredero exterior 300 largo 239 alto	1	APC304	822	822
Puerta IZ corredera 3 Plafones Iguales	1	PCA344	317	317
Puerta CEN corredera 3 Plafones Iguales	1	PCB344	317	317
Puerta DR corredera 3 Plafones Iguales	1	PCC344	317	317
Estante armario	6	ET80	34	204
Barra colgar armario	3	BC10	28	84
TOTAL COMPOSICIÓN 45				2061



46

Descripción	Ud.	Ref	Puntos	Total
Estructura armario corredero exterior 300 largo 239 alto	1	APC304	822	822
Puerta IZ corredera 3 Plafones Iguales Stone	1	PTA344	334	334
Puerta CEN corredera 3 Plafones Iguales Stone	1	PTB344	334	334
Puerta DR corredera 3 Plafones Iguales Stone	1	PTC344	334	334
Estante armario	6	ET80	34	204
Barra colgar armario	3	BC10	28	84
TOTAL COMPOSICIÓN 46				2112

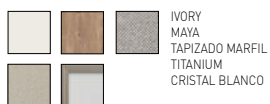

47

Descripción	Ud.	Ref	Puntos	Total
Estructura armario corredero exterior 300 largo 239 alto	1	APC304	822	822
Puerta IZ corredera LUX 1 Plafón Cristal	1	PVA404	880	880
Puerta CEN corredera LUX 1 Plafón Cristal	1	PVB404	880	880
Puerta DR corredera LUX 1 Plafón Cristal	1	PVC404	880	880
Cajonera 2 cajones Rail System	1	CG2310R	234	234
Estante armario Rail System	1	ET80R	48	48
Estante armario Rail System	11	ET85R	39	429
Estante extraíble Rail System	3	ETT80R	80	240
Zapatero extraíble Rail System	2	EX103R	89	178
Columna metálica armario	1	CAL2	96	96
Barra extensible y abatible	1	BRT	110	110
Barra colgar armario Rail System	1	BC10R	30	30
Iluminacion armario	3	LED20	288	864
Rail System	3	RAIL	110	330

ZONA CAMA

Cabezal tapizado SET 160x120	2	C49T	400	800
Cama GOA 190x150	1	GOAT/10	377	377
Módulo con tapa sin zócalo 2 cajones (VITA)	1	MT282	174	174
Mesita Shitake M	1	TB40	92	92
Mesita Shitake L	1	TB50	102	102

TOTAL COMPOSICIÓN 47

7566

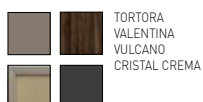

48

Descripción	Ud.	Ref	Puntos	Total
Módulo 2 cajones	1	MCL282	190	190
Tapa módulo 1 cm	2	T4110	23	46
Tapa módulo 1 cm	2	T4108	20	40
Forro a costado módulo 1 cm	4	CM4136	18	72
Módulo 2 cajones	1	MCL262	165	165
Estructura armario corredero interior 460 largo 239 alto	1	APL464	1204	1204
Puerta corredera LUX 1 Plafón Cristal	4	PLV134	496	1488
Cajonera 2 cajones	4	CG2310	210	840
Estante armario	10	ET80	34	340
Barra colgar armario	2	BC10	28	56
Iluminación Armario	4	LED20	288	1152
Módulo 2 cajones	1	MCL202	215	215
Tapa módulo 1 cm	2	T4112	28	56
Forro a costado módulo 1 cm	2	CM4136	18	36
Cojín módulo	1	CJ10	220	220

ZONA CAMA

Cama GOA 190x150	1	GOAS/10	397	397
Cabezal SLAT 82x100	1	C90	143	143
Cabezal SLAT 165x100	1	C90	287	287
Cabezal SLAT 62x100	1	C90	108	108

TOTAL COMPOSICIÓN 48

7095



49

Descripción	Ud.	Ref	Puntos	Total
Cabezal SLAT 80x100	1	C90	139	139
Cabezal SLAT 165x100	1	C90	287	287
Mesita Shitake L	1	TB50	102	102
Cama GOA 190x150	1	GOAT/10	377	377
Módulo 2 cajones	2	MCL282	190	380
Tapa módulo 1 cm	2	T4118	42	84
Forro a costado módulo 1 cm	3	CM4136	18	54

TOTAL COMPOSICIÓN 49

1423



50

Descripción	Ud.	Ref	Puntos	Total
Cabezal SLAT 60x80	2	C90	84	168
Cabezal tapizado SET	1	C49T	375	375
Cama GOA 190x150	1	GOAS/10	397	397
Módulo 2 cajones	2	MCL252	158	316
Tapa módulo 1 cm	4	T4106	19	76
Forro a costado módulo 1 cm	4	CM4136	18	72
TOTAL COMPOSICIÓN 50				1404



51

Descripción	Ud.	Ref	Puntos	Total
Cabezal SLAT 60x80	2	C90	84	168
Cabezal SLAT 165x80	1	C90	230	230
Cabezal SLAT 80x15	1	C90	87	87
Cama GOA 190x150	1	GOAS/10	397	397
Módulo 2 cajones	1	MCL252	158	158
Tapa módulo 1 cm	2	T4106	19	38
Forro a costado Módulo 1 cm	2	CM4136	18	36
Mesa colgada invertida a 80 largo (VITA)	1	MC100	95	95
TOTAL COMPOSICIÓN 51				1209



52

Descripción	Ud.	Ref	Puntos	Total
Estructura armario corredero interior 460 largo 239 alto	1	APL464	1204	1204
Puerta corredera LUX 1 Plafón Base	2	PL144	361	722
Puerta corredera LUX 1 Plafón Cristal	2	PLV144	651	1302
Cajonera 2 cajones	1	CG2312	308	308
Estante armario	10	ET80	34	340
Barra colgar armario	3	BC10	28	84
Iluminación armario	4	LED20	288	1152
Módulo 6 cajones (VITA)	2	MK666	307	614
Tapa módulo 1 cm	4	T4106	19	76
Forro a costado módulo 1 cm	4	T4112	28	112
ZONA CAMA				
Cabezal FRAMED 280x80	1	CFR	269	269
Módulo 2 cajones	1	MCL252	158	158
Tapa módulo 1 cm	2	T4106	19	38
Forro a costado módulo 1 cm	2	CM4136	18	36
Cama GOA 190x150	1	GOAT/10	377	377
Mesita Shitake M	1	TB40	92	92
Mesita Shitake L	1	TB50	102	102
TOTAL COMPOSICIÓN 52				7315



53

Descripción	Ud.	Ref	Puntos	Total
Estructura armario corredero interior 460 largo 239 alto	1	APL464	1204	1204
Puerta corredera LUX 1 Plafón Base	2	PL144	361	722
Puerta corredera LUX 1 Plafón Stone	2	PLS144	383	766
Cajonera 2 cajones	2	CG2310	210	420
Estante armario	10	ET80	34	340
Barra colgar armario	3	BC10	28	84
Iluminación armario	4	LED20	288	1152
ZONA CAMA				
Cabezal FRAMED 280x80	1	CFR	269	269
Complemento tapizado 278x48	1	CFT	307	307
Módulo 2 cajones	1	MCL252	158	158
Tapa módulo 1 cm	2	T4106	19	38
Forro a costado módulo 1 cm	2	CM4136	18	36
Cama GOA 190x150	1	GOAS/10	397	397
Módulo 2 cajones	1	MCL282	190	190
Tapa módulo 1 cm	2	T4110	23	46
Forro a costado módulo 1 cm	2	CM4136	18	36
TOTAL COMPOSICIÓN 53				6165

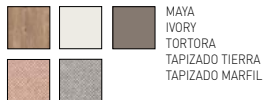

54

Descripción	Ud.	Ref	Puntos	Total
Estructura armario corredero interior 370 largo 239 alto	1	APL374	959	959
Puerta IZ Corredera 3 Plafones Combinables	1	PL64	334	334
Puerta CEN Corredera 3 Plafones Combinables	1	PL64	334	334
Puerta DR Corredera 3 Plafones Combinables	1	PL64	334	334
Division interior armario	1	DNT203	58	58
Base extraíble (Serie+)	4	EBC3	154	616
Cajón extraíble (Serie +)	2	CR456	60	120
Zapatero extraíble (Serie +)	1	ZR456	53	53
Cajón organizador (Serie +)	1	CML6	131	131
Estantearmario	1	ET84	22	22
Barra colgar armario	1	BC4	16	16
Estante armario	5	ET82	39	195
Barra colgar armario	2	BC12	35	70
Barra colgar armario	1	BC10	28	28

ZONA CAMA

Cabezal DUE tapizado 260x75	2	DUET	650	1300
Canape elevable frontal 190x150	1	CEF/10	614	614
Moulo diafano	1	MCL100	98	98
Estantería colgada vertical (VITA)	1	ST36	125	125

TOTAL COMPOSICIÓN 54

5407



55

Descripción	Ud.	Ref	Puntos	Total
Estructura armario corredero interior 370 largo 239 alto	1	APL374	959	959
Puerta IZ corredera 1 Plafón	1	PL24	281	281
Puerta CEN corredera 1 Plafón	1	PL24	281	281
Puerta DR corredera 1 Plafón	1	PL24	281	281
Estante armario	6	ET82	39	234
Barra colgar armario	3	BC12	35	105

TOTAL COMPOSICIÓN 55

2141



56

Descripción	Ud.	Ref	Puntos	Total
Estructura armario corredero interior 370 largo 239 alto	1	APL374	959	959
Puerta IZ corredera 1 Plafón	1	PL24	281	281
Puerta CEN corredera 1 Plafón	1	PL24	281	281
Puerta DR corredera 1 Plafón	1	PL24	281	281
Estante armario	6	ET82	39	234
Barra colgar armario	3	BC12	35	105

TOTAL COMPOSICIÓN 56

2141



57

Descripción	Ud.	Ref	Puntos	Total
Columna vestidor Izquierda 239 alto 45 ancho	1	CLZ44	85	85
Columna vestidor Central 239 alto 45 ancho	8	CLC44	89	712
Columna vestidor Derecha 239 alto 45 ancho	1	CLD44	85	85
Buc sup/inf vestidor	14	BU48	33	462
Buc rincón sup/inf vestidor	4	BUR8	96	384
Estante vestidor	16	ET88	32	512
Estente rincón vestidor	8	ETR8	96	768
Pantalonero vestidor	2	PNT686	164	328
Cajonera 2 cajones vestidor	3	CG258C	158	474
Barra colgar vestidor	5	BC8	25	125
Trasera vestidor	11	TSR18	62	682
Moldura rincón vestidor	2	ML239	47	94
Sistema iluminación	9	LED20	288	2592

TOTAL COMPOSICIÓN 57

7303



IVORY
FOREST

58

Descripción	Ud.	Ref	Puntos	Total
Columna vestidor IZ 239 alto	1	CLZ44	85	85
Columna vestidor CEN 239 alto	4	CLC44	89	356
Columna vestidor DR 239 alto	1	CLD44	85	85
Buc sup/inf vestidor	10	BU48	33	330
Estante vestidor	11	ET88	32	352
Barra colgar vestidor	5	BC8	25	125
Pantalonero vestidor	2	PNT686	164	328
Cajonera 2 cajones vestidor	3	CG258C	158	474
Trasera vestidor	5	TSR18	62	310
Columna vestidor Izquierda 239 alto	1	CLZ44	85	85
Columna vestidor Central 239 alto	3	CLC44	89	267
Columna vestidor Derecha 239 alto	1	CLD44	85	85
Buc sup/inf vestidor	8	BU48	33	264
Estante vestidor	16	ET88	32	512
Cajonera 2 cajones vestidor	4	CG258C	158	632
Trasera vestidor	4	TSR18	62	248
TOTAL COMPOSICIÓN 58				4538



TORTORA
VALENTINA

59

Descripción	Ud.	Ref	Puntos	Total
Columna vestidor Izquierda 239 alto	1	CLZ44	85	85
Columna vestidor Central 239 alto	4	CLC44	89	356
Columna vestidor Derecha 239 alto	1	CLD44	85	85
Buc sup/inf vestidor	2	BU45	26	52
Estante vestidor	2	ET85	25	50
Barra colgar vestidor	1	BC5	19	19
Trasera vestidor	1	TSR15	39	39
Buc ricón sup/inf vestidor	2	BUR8	96	192
Estante ricón vestidor	2	ER54	96	192
Barra ricón vestidor	1	BN	50	50
Trasera vestidor	2	TSR10	78	156
Moldura ricón vestidor	1	ML239	47	47
Buc sup/inf vestidor	6	BU410	35	210
Estante vestidor	5	ET80	34	170
Barra colgar vestidor	2	BC10	28	56
Pantalonero vestidor	1	PNT106	180	180
Pantalonero vestidor	1	PNT606	150	150
Cajon cajonera costilla 11	1	CGN316	52	52
Cajon cajonera costilla 16	2	CGN366	56	112
Cajon cajonera costilla 25	1	CGN356	69	69
Tapas cajonera libre composición	1	CFN346	55	55
Cajón cajonera costilla 11	1	CGN310	66	66
Cajón cajonera costilla 16	2	CGN360	70	140
Cajón cajonera costilla 25	1	CGN350	73	73
Tapas cajonera libre composición	1	CFN380	78	78
Trasera vestidor	3	TRS10	78	234
Sistema iluminación LED	5	LED20	288	1440
Modulo 4 cajones Libre Configuración	2	MCL484	303	606
Modulo 4 cajones Libre Configuración	1	MCL404	351	351
Forro grueso 1 cm	2	CM4172	20	40
Forro grueso 1 cm Especial	1	CM4172	20	20
Tapa grueso 1 cm Especial	1	T4114	32	32
TOTAL COMPOSICIÓN 59				5476

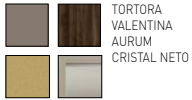

60

Descripción	Ud.	Ref	Puntos	Total
Estructura armario batiente 50 largo 239 alto	1	ARB54Z	187	187
Estante armario	2	ET65	25	50
Barra colgar armario	1	BC5	19	19
Puerta IZ LUX Cristal	1	PVQ4Z	330	330
Estructura Armario rincón batiente 100 largo 100 Ancho 239 Alto	1	AR4	440	440
Estante armario rincón	2	ETR8	96	192
Barra curva rincón	1	BN	50	50
Puerta IZ LUX Cristal	1	PVQ4Z	330	330
Puerta DR LUX Cristal	1	PVQ4D	330	330
Estructura armario batiente 300 largo 239 alto	1	ARB304	720	720
Estante armario	5	ET64	29	145
Barra colgar armario	2	BC10	28	56
Pantalonero armario	1	PNT101	172	172
Pantalonero armario	1	PNT601	144	144
Cajon cajonera costilla 11	1	CGN116	50	50
Cajon cajonera costilla 16	2	CGN166	53	106
Cajon cajonera costilla 25	1	CGN156	65	65
Tapa cajonera libre composición	1	CFN146	37	37
Cajon cajonera costilla 11	1	CGN110	62	62
Cajon cajonera costilla 16	2	CGN160	65	130
Cajon cajonera costilla 25	1	CGN150	77	77
Tapa cajonera libre composición	1	CFN180	50	50
Puerta IZ LUX Cristal	3	PVQ4Z	330	990
Puerta DR LUX Cristal	3	PVQ4D	330	990
Sistema Iluminación	5	LED20	288	1440
Modulo 4 cajones Libre Configuración	2	MCL484	303	606
Modulo 4 cajones Libre Configuración	1	MCL404	351	351
Forro grueso 1 cm	2	CM4172	20	40
Forro grueso 1 cm Especial	1	CM4172	20	20
Tapa grueso 1 cm Especial	1	T4114	32	32
TOTAL COMPOSICIÓN 60				8211



61

Descripción	ud.	Ref	puntos	total
Columnas Metalicas	5	CA240	111	555
Estante Vestidor	10	ET48	66	660
Barra Colgar Vestidor	3	BC8R	42	126
Pantalonero Vestidor	2	PNT607	156	312
Cajonera 2 Cajones Vestidor	2	CG282	205	410
TOTAL COMPOSICION 61				2063



62

Descripción	ud.	Ref	puntos	total
Columnas Metalicas	5	CA240	111	555
Estante Vestidor	10	ET48	66	660
Barra Colgar Vestidor	3	BC8R	42	126
Pantalonero Vestidor	2	PNT607	156	312
Cajonera 2 Cajones Vestidor	2	CG282	205	410
TOTAL COMPOSICION 62				2063



63

Descripción	Ud.	Ref	Puntos	Total
Estructura armario batiente 200 largo 239 alto	1	ARB204	494	494
Puerta DR Enmarcada LUX Cristal VETA	1	PVQ4D	330	330
Puerta DR Enmarcada LUX	1	PJQ4D	200	200
Puerta IZ Enmarcada LUX	2	PJQ4Z	200	400
Partidor	1	DNT30	64	64
Estante	5	ET65	25	125
Estante	2	ET60	34	68
Barra colgar	2	BC10	28	56
Estante Zapatero extraíble	7	EX51	63	441
Iluminación LED	3	LED20	288	864
TOTAL COMPOSICIÓN 63				3042



64

Descripción	Ud.	Ref	Puntos	Total
Módulo abatible	1	ACP101	144	144
Módulo diáfano especial	2	C136	40	80
Tapa para módulos grosor	1	T4114	32	32
TOTAL COMPOSICIÓN 64				256



65

Descripción	Ud.	Ref	Puntos	Total
Columna metálica DOT LINE	3	ED14	112	336
Estante DOT LINE	3	EDL25	74	222
TOTAL COMPOSICIÓN 65				558



66

Descripción	Ud.	Ref	Puntos	Total
Módulo puerta IZ Libre Configuración	1	MCL46Z	143	143
Módulo diáfano Libre Configuración	1	MCL460	109	109
Módulo 4 cajones Libre Configuración	1	MCL464	261	261
Módulo puerta IZ Libre Configuración	1	MCL46D	143	143
Tapa para módulos grueso 1cm	2	T4125	57	114
Forro módulos 1cm grueso	2	CM4172	20	40
TOTAL COMPOSICIÓN 66				810



67

Descripción	Ud.	Ref	Puntos	Total
Estructura armario plegable 200 largo 170 alto	1	ARP204	524	524
Puerta IZ Plegable LUX Cristal	1	PVA514	364	364
Puerta DR Plegable LUX Cristal	1	PVB514	360	360
Puerta IZ Plegable LUX Cristal	1	PVC514	360	360
Puerta DR Plegable LUX Cristal	1	PVD514	364	364
Estante	6	ET80	34	204
Columna Derecha estantería (VITA)	1	925D	63	63
Columna Central estantería (VITA)	2	925C	63	126
Columna Izquierda estantería (VITA)	1	923C	60	60
Buc estantería (VITA)	6	934B	22	132
Estante estantería (VITA)	8	E934	20	160
Trasera estantería (VITA)	2	8TR10	21	42
Trasera estantería (VITA)	1	8TR10	16	16
Tapa módulos 1cm grueso	1	T4120	46	46
Módulo cama cubo sin zócalo fondo 50cm Especial (VITA)	2	CB531	214	428
Módulo Diáfano Fuelle	1	DFB45	267	267
Módulo Libre Configuración 1 cajón	4	MCL181	134	536
Tapa módulos 1cm grueso Especial	4	T4108	35	140
Forro módulos 1cm grueso Especial	4	CM4118	20	80
Mesita Shitake L	1	TB50	102	102
Mesita Shitake M	1	TB40	92	92
TOTAL COMPOSICIÓN 67				4466



68

Descripción	Ud.	Ref	Puntos	Total
Módulo cama cubo sin zócalo fondo 50 cm	3	CB531	171	513
Módulo diafano	2	CNF40	118	236
Estructura armario batiente 100 largo 209 alto	1	ARB104	261	261
Puerta DR Enmarcada LUX Cristal	1	PVQ4D	314	314
Puerta IZ Enmarcada LUX Cristal	1	PVQ4Z	314	314
Estante	4	ET60	34	136
Estructura armario plegable 200 largo 185 alto	1	ARP204	524	524
Puerta IZ Pleg. A LISA	1	PGA404	82	82
Puerta IZ Pleg. B LISA	1	PGB404	78	78
Puerta DR Pleg. C LISA	1	PGC404	78	78
Puerta DR Pleg. D LISA	1	PGD404	82	82
Estante	6	ET80	34	204
Estructura armario batiente 50 largo 239 alto	1	ARB54D	187	187
Puerta IZ LISA	1	PJA4Z	68	68
Estante	1	ET65	25	25
Estante extraíble	3	ETT65	57	171
TOTAL COMPOSICIÓN 68				3273



69

Descripción	Ud.	Ref	Puntos	Total
Estructura armario plegable 200 Largo 239 Alto	1	ARP204	524	524
Puerta IZ Pleg. A Enmarcada LUX Cristal	1	PVA514	364	364
Puerta IZ. Pleg. B Enmarcada LUX Cristal	1	PVB514	360	360
Puerta DR Pleg. C Enmarcada LUX Cristal	1	PVC514	360	360
Puerta DR. Pleg. D Enmarcada LUX Cristal	1	PVD514	364	364
Estante	9	ET80	34	306
Barra de colgar	1	BC10	28	28
Columna vestidor IZ	1	CLZ44	85	85
Columna vestidor CEN	4	CLC44	89	356
Columna vestidor DR	1	CLD44	85	85
Buc recto vestidor	6	BU44	23	138
Buc recto vestidor	1	BU412	40	40
Buc recto vestidor	1	BU48	33	33
Estante	15	ET84	22	330
Estante	3	ET88	32	96
Estante extraible	1	ETT88	64	64
Estante	1	ET80	34	34
Tapa módulo grueso 3	1	T4310	51	51
Barra de colgar	1	BC10	28	28
Trasera	3	TSR14	31	93
Trasera	1	TSR10	78	78
Trasera	1	TSR18	62	62
Módulo sin tapa sin zócalo 5 cajones Especial	1	MK565	325	325
Módulo sin tapa sin zócalo 5 cajones Especial	1	MK545	288	288
Estante pared soporte oculto	1	854	72	72
TOTAL COMPOSICIÓN 69				4564



70

Descripción	Ud.	Ref	Puntos	Total
Armario puertas batientes 150 ancho 239 alto	1	ARB154	384	384
Puerta DR LISA	1	PJA4D	68	68
Puerta IZ LISA	1	PJA4Z	69	69
Partidor	1	DNT30	64	64
Estantes	6	ET65	25	150
Estantes	6	ET60	34	204
Altillo 4 puertas (VITA)	1	AL4120	474	474
Encimera 5cm grueso (VITA)	1	S4520	142	142
Módulo contenedor + 2 cajones (VITA)	1	MK453	222	222
Módulo Diáfano (VITA)	1	MK450	105	105
Estructura armario corredero interior 240 ancho 239 alto	1	APL244	650	650
Puerta corredera RÚSTICA	2	PL104	365	730
Estante armario	2	ET82	39	78
Barra colgar armario	1	BC12	35	35
División interior armario	1	DNT303	64	64
Estante armario	10	ET86	29	290
TOTAL COMPOSICIÓN 70				3729



71

Descripción	Ud.	Ref	Puntos	Total
Armario Terminal	1	ART47Z	319	319
Puerta IZ LISA	1	PJA4Z	68	68
Estructura armario rincón batiente 100 largo 100 fondo 239 alto	1	AR4	440	440
Puerta DR LISA	1	PJA4D	68	68
Puerta IZ LISA	1	PJA4Z	68	68
Estante rincón	5	ETR8	96	480
Estructura armario batiente 50 largo 239 alto Abuhardillado	4	ARB54Z	287	1148
Estante armario	10	ET65	25	250
Barra de colgar	2	BC5	19	38
Cajonera 2 cajones costilla 11	4	CG2116	137	548
Puerta DR LISA	4	PJA4D	68	272
Columna vestidor Izquierda	1	CLZ44	85	85
Columna vestidor Central	1	CLC44	89	89
Columna vestidor Derecha	1	CLD44	85	85
Buc vestidor recto	2	BU410	35	70
Buc vestidor recto Abuhardillado	2	BU410	35	70
Trasera abuhardillada	2	TSR10	78	156
Incremento buhardilla vestidor (cuerpo)	2	SUPL	100	200
Estante	5	ET80	34	170
Cajonera 2 cajones costilla 11 Colgada	2	CG2310	210	420
Mesa colgada invertida Especial (VITA)	1	MC200	196	196
Tirador WOOD 10	5	WOOD10	11	55
ZONA CAMA				
Arrimadero grueso 3	1	AM3	120	120
Arrimadero grueso 3	1	AM3	151	151
Cabezal para camas cubo (VITA)	1	CP5	71	71
Cubo bajo sin zócalo (VITA)	3	CBD31	215	645
Arcón rincón cubos (VITA)	1	CB3Z	180	180
TOTAL COMPOSICIÓN 71			6462	



72

Descripción	Ud.	Ref	Puntos	Total
Cabezal WALL 200 largo 110 alto	3	CLV	202	606
Tapa cabezal WALL 200 largo	3	CLT	87	261
Bicama fija 59 alto (VITA)	1	CF59/4	334	334
Cama deslizante (VITA)	1	CT54/4	397	397
Arcón cajones (VITA)	1	CS422	311	311
Módulo 2 cajones Libre Configuración	1	MCL262	165	165
Módulo puerta abatible Libre Configuración	2	MCL26A	132	264
Tapa grueso 1 cm	2	T4118	42	84
Pata OSLO lacada vulcano	5	PSL1	34	170
Encimera 5 grueso (VITA)	1	S6520	156	156
Pata OSLO XL lacada vulcano (VITA)	2	PSL	72	144
Módulo 2 puertas	1	MAB40P	187	187
Encimera módulo	1	T4210	29	29
Módulo bajo sin puerta	1	MAB45Z	105	105
Módulo bajo 1 puerta IZ	1	MAB45Z	135	135
Módulo bajo 4 cajones	1	MAB45	249	249
Cubo fuelle	1	CNF41	152	152
Módulo alto sin puerta	1	MAT45Z	105	105
Módulo alto 2 puertas	1	MAT40P	187	187
Módulo 1 puerta Especial	1	MAH75D	286	286
Barra colgar	1	BC5	19	19
Módulo 2 cajones Libre Configuración	1	MCL202	215	215
Cojín	1	CJ80	200	200
Columna metálica	2	CA240	111	222
Estante vestidor	3	ET410	71	213
Barra colgar vestidor	1	BC8R	42	42
TOTAL COMPOSICIÓN 72			5238	



IVORY
FOREST
CRISTAL NETO

73 ZONA ARMARIO

Descripción	Ud.	Ref	Puntos	Total
Estructura armario batiente 200 Largo 239 Alto	1	ARB204	494	494
Puerta DR Enmarcada LUX Cristal	2	PVQ4D	330	660
Puerta IZ Enmarcada LUX Cristal	2	PVQ4Z	330	660
Estante	4	ET60	34	136
Estante	4	ET65	25	100
Partidor	1	DNT30	64	64
Estante Zapatero extraíble	6	EX51	63	378
Cajonera Libre Configuración	1	CFN180	50	50
Cajón Libre Configuración costilla 22	1	CGN150	77	77
Cajón Libre Configuración costilla 11	2	CGN110	62	124
Armario Rincón puertas batientes	2	AR4	440	880
Puerta Enmarcada DR LUX Cristal	2	PVQ4D	330	660
Puerta Enmarcada IZ LUX Cristal	2	PVQ4Z	330	660
Estante rincón	4	ETR8	96	384
Barra colgar de rincón	4	BN	50	200
Estructura armario plegable 200 Largo 239 Alto	1	ARP204	524	524
Puerta IZ Pleg. A Cristal LUX	1	PVA514	364	364
Puerta IZ. Pleg. B Cristal LUX	1	PVB514	360	360
Puerta DR Pleg. C Cristal LUX	1	PVC514	360	360
Puerta DR. Pleg. D Cristal LUX	1	PVD514	364	364
Estante	2	ET80	34	68
Casillero Especial	3	CS102	138	414
Cajonera Libre Configuración Especial	2	CFN368	67	134
Cajon Libre Configuración costilla 22	2	CGN358	77	154
Cajon Libre Configuración costilla 11	6	CGN318	60	360
Estructura armario batiente 200 largo 239 alto	1	ARB204	494	494
Puerta DR Enmarcada LUX Cristal	2	PVQ4D	330	660
Puerta IZ Enmarcada LUX Cristal	2	PVQ4Z	330	660
Estante	3	ET60	34	102
Estante Zapatero inclinado	6	EN101	56	336
Pantalonero	1	PNT101	172	172
Armario terminal Especial	1	ART48	234	234
Mesa colgada invertida	1	MC150	154	154
Arrimadero grueso 3	1	AM3	131	131
Iluminación LED	8	LED20	288	2304
Módulo 2 cajones Libre Configuración	1	MCL202	215	215
Tapa módulos grueso 1cm	2	T4112	28	56
Forro módulos grueso 1cm	2	CM4136	18	36
Cojín	1	CJ10	220	220
TOTAL COMPOSICIÓN 73 ARMARIO				14403



FOREST
TORTORA
TAPIZADO TIERRA

73 ZONA CAMA

Descripción	Ud.	Ref	Puntos	Total
Cabezal STRIP	3	C40	247	741
Cabezal WALL	1	CLV	58	58
Tapa WALL con led	1	CLL	152	152
Cabezal WALL	1	CLV	106	106
Tapa WALL con led	1	CLL	166	166
Cabezal WALL	1	CLV	46	46
Tapa WALL con led	1	CLL	152	152
Cabezal SET Tapizado	1	C49T	501	501
Módulo sin tapa sin zócalo 2 cajones (VITA)	1	MK262	151	151
Tapa 1cm	1	T4106	19	19
Aro cama GOA Tapizado 190x150	1	GOAT/10T	647	647
Mesita Shitake L	1	TB50	102	102
TOTAL COMPOSICIÓN 73 ZONA CAMA				2739

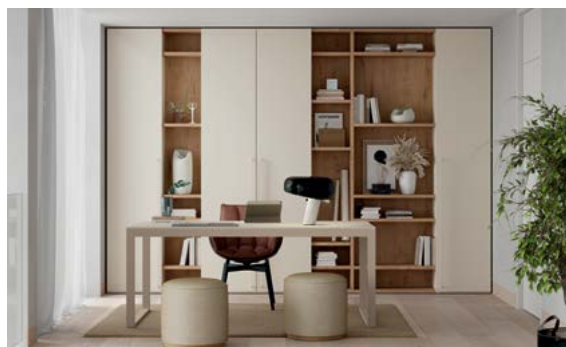

IVORY
FOREST

74

Descripción	Ud.	Ref	Puntos	Total
Columna estantería Izquierda	1	CTB34Z	85	85
Columna estantería Central	5	CTB34C	85	425
Columna estantería Derecha	1	CTB34D	85	85
Buc estantería	4	BTB34	21	84
Buc estantería	4	BTB35	22	88
Buc estantería	4	BTB31	37	148
Trasera estantería	2	8TR10	27	54
Trasera estantería	2	8TR10	34	68
Trasera estantería	2	8TR10	70	140
Estante estantería	10	ETB34	20	200
Estante estantería	8	ETB35	21	168
Estante estantería	10	ETB31	35	350
Puerta IZ estantería solape total Especial Tir. Onix	2	PBCZ	145	290
Puerta DR estantería solape total Especial Tir. Onix	2	PBCD	145	290
Mesa Especial	1	MESP	348	348

TOTAL COMPOSICIÓN 74 **2823**



IVORY
FOREST

75

Descripción	Ud.	Ref	Puntos	Total
Columna estantería Izquierda	1	CTB34Z	85	85
Columna estantería Central	3	CTB34C	85	255
Columna estantería Derecha	1	CTB34D	85	85
Buc estantería	2	BTB35	22	44
Buc estantería	6	BTB31	37	222
Trasera estantería	1	8TR10	34	34
Trasera estantería	3	8TR10	70	210
Estante estantería	5	ETB35	21	105
Estante estantería	17	ETB31	35	595
Puerta IZ estantería Solape Total	1	PBCZ	30	30
Puerta IZ estantería Solape Total	1	PBCZ	32	32
Puerta IZ estantería Solape Medio	1	PBCZ	25	25
Puerta IZ estantería Solape Medio	2	PBCZ	26	52
Puerta DR estantería Solape Medio	1	PBCD	25	25
Puerta DR estantería Solape Medio	2	PBCD	26	52
Puerta IZ estantería Solape Medio	2	PBCZ	30	60
Puerta DR estantería Solape Medio	1	PBCD	30	30
Puerta DR estantería Solape Medio	1	PBCD	32	32
Puerta DR estantería Solape Total	1	PBCD	30	30
Puerta DR estantería Solape Total	1	PBCD	32	32

TOTAL COMPOSICIÓN 75 **1911**



IVORY
FOREST

76

Descripción	Ud.	Ref	Puntos	Total
Módulo Bajo Armarios Modulares 2 ptas	2	MAJ60P	307	614
Módulo Bajo Armarios Modulares 1 pta DR	1	MAJ65D	210	210
Módulo Alto Armarios Modulares 2 ptas	2	MAH50P	277	554
Módulo Alto Armarios Modulares 1 pta DR	1	MAH55D	185	185
Cubo Inside	1	CNS60	118	118
Cubo Fuelle	1	CNF615	174	174
Partidor RIB	5	PRB53	25	125
Estructura armario batiente 100 largo 239 alto	1	ARB104	261	261
Puerta DR LISA	1	PJA4D	68	68
Puerta IZ LISA	1	PJA4Z	68	68
Estante	4	ET60	34	136

TOTAL COMPOSICIÓN 76 **2513**

CONDICIONES GENERALES DE VENTA

DISEÑO: EQUIPO jotajotape

CONTADO: 2% descuento por pronto pago, mediante giro a 20 días fecha factura. (cumplimentación SEPA CORE)

GIROS: Máximo 60 días, sin descuento, según Ley 3/2004 de 29 de diciembre y su modificación Ley 15/2010 de 05 julio de lucha contra morosidad.

No se expedirán mercancías mientras se encuentren impagados algunos documentos de cobro.

No se aceptarán giros no domiciliados.

Las facturas inferiores a 100 euros serán de un solo giro.

A los impagados se les incrementarán los intereses de demora y los gastos pertinentes.

Todo pedido cursado a MUEBLES JJP, S.A. está sujeto a las condiciones de venta y pago contenidas en esta página.

DEVOLUCIÓN DE MERCANCIAS

Sólo se admitirán las piezas **embaladas** que estén en perfectas condiciones, abonándose el **80%** del importe facturado en su día, previa consulta con fábrica.

Todas las piezas cortadas a medida, **no se podrán devolver a fábrica para abonar, ni anular una vez cursado el pedido.**

Al avisar a fábrica hay que facilitar el número de albarán correspondiente a dicha mercancía.

No se admitirá la devolución de piezas especiales.

El cliente dispone de un plazo de 45 días para notificar incidencias derivadas del transporte (golpes, rayadas, ...). A su vez deberá mandar la pieza afectada como evidencia de la incidencia para formalizar la reclamación. Pasado este plazo MUEBLES JJP entiende que el proceso de entrega se ha realizado de forma satisfactoria.

MEDIDAS ESPECIALES

Se deberá consultar con fábrica para poder determinar su viabilidad y plazo de entrega.

Los puntos y descripciones de este catálogo, en especial en las composiciones, son correctos salvo error tipográfico u omisión involuntaria en la creación de este Catálogo Técnico.

MUEBLES JJP se reserva el derecho de modificar cualquier pieza de esa tarifa sin previo aviso, siempre que lo considere oportuno, para mejorar su calidad o prestaciones sobre cualquier elemento detallado en esta tarifa.